

it would solve all of the problems then. Do you know who you are? There is nine planets to the Universe you just happen to have nine holes in your body do you think thats an accident? Thats because you are the Universe, you are nature. You got twenty-six thousand billion cells in your body, sixty-two thousand miles of blood vessels in your body that blood makes a complete cycle every thirty seconds which means your blood travels 104,000 miles a minute. You know how strong you are? Do you know who you are? I hope you youngsters understand nature. Let me show you how strong nature is: Those of you in here this evening that understand Chinese raise your hands would you please. one-two-three- four- five-six-seven-eight. In this huge audience only eight folks understand Chinese. I said that to prove to you how strong nature is, you all aware that right this moment in China dogs in China do understand Chinese and never been to college. Dogs in Russia understand Russian. Dogs in Germany understand German. Do you? I say that to say that to nature you born with all the wisdom you need to get human dignity to fight your way out of one of these tricks and get to your dinner. Don't nobody have to teach you that. (clapping).

So you youngsters got a big job. I hope you know how strong you are. As you youngsters work to change this system I hope you dedicate a lot of your energy and a lot of your efforts to those educational institutions. I hope you make them for the first time in the history of America live up to their name. I hope you make them educate because the average school in America do not know how to educate. They've been to damn busy in doctrinating and there is a difference between unindoctrination and education. (clapping). Why are we so busy programing you youngsters. You come to school and we give you books and here is your class assignment. Read the book. Oh we don't get you with the book we _____ after you finish reading the book we give you what we call the test and if you didn't read the book the way we want you to read the book, you can not pass the test. Thats programing. (Clapping). Thats why young folks in America will stoop to the lowest depth they ever stooped in their life to steal the test, because you know once you get the test you don't need the book. (laughing). We do not grade the book we grade the test and after we get through grading the test we put it on that ole fragile thing called a transcript and I don't know when you

youngsters are going to get hip to that transcript. That transcript is not for you _____ don't mean you know that's the way the system checks on you, that's all a transcript is for. If you think that transcripts important to you - you graduate from college one day and ten years from now meet somebody you want to marry and see if they ever ask to see your transcript. (laughing). You graduate from college and you get a diploma and to to apply for a job and they say well we got to check your transcript don't check my transcript I didn't ask to check your damn books did I? (clapping).

You youngsters got a big job. Changes in these educational institution so for the first time they can be relevant to your needs in the year of 1969 not that old _____ stuff we've been teaching in these colleges and universities. You all got a big job, hell somebody going to stand in front of you in class and flunk you, who has the power to flunk you? Nature, its like flunking a hurricane. (laughing and clapping). The most they can do is give you incomplete and give you the rest of your life to complete it, that makes sense. (laughing and clapping). That ole nonsense grading system, you made

a 100, you made now, who gives a hell what you got a pass or incomplete its just that simple, just that simple. What does a 100 mean? Because you made a 100 on every test that going to make you a better daddy? Because you made a 100 on that that makes you a better citizen? Nine time out of ten with that old system we don't do nothing but make a damn fool out of you. Check the records _____, they own their own business, they ain't working for somebody. You youngsters really got to overhaul this system and I hope you do it before my kids get here. (clapping). Because I know my kid is not going to be as patient as you all was. They aren't going to take over the administration building, they would be standing out there marching where the building was. (laughing and clapping). Sad thing about what is going on on college campuses today, that everybody is upset over young folks get the president of these institutions would live up to their jobs and their committments they would raise enough hell to make all these changes you need. Hell if the president really thought anything of you youngsters, (clapping), he would be so busy making these changes if you wasn't with him he

would to take over the student union so you couldn't get in it. Come to your dormitory and steal your records. The average president of these institutions so damn busy out making fund raising pitches and keeping his finger in somebody's eye and so damn scared of that board of directors now thats where the problem comes from on the colleges is that board of directors. (clapping). You want to have some fun, you write down the names of every college in America and then do some research and look up all the board of directors in America and you will find out that 98. per cent of them is the cause of the problems all over the world and the only thing that qualified them to be on the board of directors is the fact they made some money and nobody even asked them how they made it. (clapping). Look at the ROCKEFELLER family. How many college boards and university boards of directors they are? Can you imagine ROCKEFELLER is going to tell you young kids how you suppose to mold your life when it wasn't for his damn Chase Manhattan Banks them black brothers in South Africa could breathe a breath of fresh air and if it wasn't for that damn standard oil the whole continent in South America could get free and that slick, slimy, degenerate ROCKEFELLER family going to tell

you youngsters how you suppose to pattern your life, is that a disgrace? You got a big job and thats what black folks is talking about in this country today. Let me say to you tonight that black folks in America do not hate white folks, course you got some niggers hate turnips. (laughing). Basically in America black folks do not hate you white folks, we hate your stinking white racists system and your stinking white racists institutions, thats what we hate in the free society. We got to give a man the right to be an individual racists. Individual racism do not hurt me its just the damn institutional lies racism that we are going to bust, thats what is choking us to death. (clapping). As an individualist you got a right to believe our _____ your hang-up, but you haven't got a right to keep people moving, anyway I won't move in my country. (clapping).

The white folks you not our problem. I guess its just your ego that wants to make yourself believe you our problem. (clapping). When you really stop and think about it you really insignificant in as far as my problem is concerned and to prove that, all you white folks could disappear from America tonight and leave nothing here but

Indians, Mexicans, Puerto Ricans, Black folks and Asians and if we had to take these same old trick tests you made us take now, we still couldn't get into college and you wouldn't even be here. (laughing and clapping). So I say to you tonight Black folks in America, do not hate you white folks, we hate your stinking white racist system and your stinking white racist institutions but we want you to know we are going to hold all white folks responsible for it. You do know what I mean don't you? (clapping).

Like if you came to my house this evening as my friend and brought your daughter with you and my dog attacked your daughter, who you going to sue? My dog or me? I'm responsible for my dog. We saying to you white folks in America you responsible for this dog ass racists system that keeps attacking us. (clapping). Both of you came by my house this evening as my friend and brought your daughter with you and my dog lunged for your daughter and I got in the way and that dog damn near killed me, you ain't got no law suit right? Matter of fact our friendship can get a little tight alright? Same thing we say in the white folks of America, either you get

in a position to stop your racist dog from attacking me or get in a position where everytime he attacks me he will grab you and if you ever do that you'd find out we ain't got no problems, (clapping). We tired of this racist system that keeps black folks locked in the black ghetto all their life. I was forced to live in a black ghetto, over crowded, rats and roaches and I had to develop a new _____ to survive and then I break out of it and go to a white school and you didn't ask me the ghetto test, you didn't ask me a damn thing about the rats and roaches, you asked me about the _____ tower, no baby you've given us the wrong test, we're black kids and we said get rid of these tests. Thats your test, don't give me your test baby, not after you forced me to live in a black ghetto all my life. You _____ enough decency after you forced me to live there to give me a test that I know about, then get rid of all the tests. (Clapping). That Indian brother, he is not on that reservation because he wants to be there, he is there because we forced him up there and if he got away tonight and wanted to come to this institution you not going to ask him a damn thing thats relevant to the reservation. First thing

you want to do is we got to give you a test _____.
(laughing). Oh what was ABRAHAM LINCOLN's mother's name?
What the hell that Indian give a damn about ABRAHAM LINCOLN's
mama? May be we would understand it a little bit better if
all Americans had to take an Indian test before we could go
to college. May be that Indian throw you up on that
reservation and ask you what was sitting Bull's great
grandma's name? We are insane enough to not only put him
up on the reservation but to control his educational
system and we got nerve enough out of all of the people
on the face of this earth we got nerve enough to teach
that Indian that COLUMBUS discovered America. (laughing
and clapping). So we say we tired of this white racist
system. I never will forget I lived in that black ghetto and
developed me a ghetto culture and I got ready to go to one of
them white schools, see I didn't have to take the test
because I was a good athlete. Come here boy, ya I got passed
that. I'm sitting and I was doing my thing, you understand?

I never will forget one day I'm sitting in the
math class and this white instructor walks over and says
how you doing boy? I say well I think I got it mastered
if I just figure out this one formula and he says, What
is it on your mind? I say, well let me break it all the

way down. I say two and two is four. He say what? I said two and two is four. He said what did you say? I said four white boy four, one-two-three-four. He said my God you colored folks do talk different. Ya, five-six-seven-eight-nine we do talk different don't we? You white folks better check your thing out _____. You run around here thinking that you talk english language and black folks can't speak the english language. I say to you, you better get on a plane and take one trip to London, England and listen to that englishman talking. You would find out you white folks in America can't speak english neither. (clapping). Ya you ain't doing nothing but _____ and _____. Thats why a trip every now and then, a good trip is good for your _____. Ya thats right, you learn a lot you know, you white folks got us pinned in the black ghetto, you give us that little piece of land, little small piéce, to small over crowded, rats and roaches and we dirtied it up because we dirtied it up white folks in America want to say we was niggers for dirting it up. Them black folks was so silly want you to make yourself believe we didn't even get nothing dirty. _____ we ain't dirty. You know white folks knows what dirt looks like. You know there is a lot of

black folks in this country silly enough to believe that if you don't see us eating watermelon you assum we ain't eating them. You know damn good and well if you see us

_____ truck loads of watermelon to haul _____ and the truck come back empty. You know what we doing with them melons don't you? (laughing). So I guess we just have to start getting honest with you and admit that we did get in that little ole piece of ghetto you gave us that was over crowded, rats and roaches and we did dirty it up. Now because we dirty it up that makes us the nigger and tonight I am willing to admit we the nigger for dirting up that little piece of land. We got to be the nigger for dirting up that little ghetto you gave us. _____ admit you who dirtied up all your rivers and your oceans, polluted your air and left all that junk on the moon. (clapping). So if we got to be niggers for dirting up that little piece of land after looking at your dirt record you got to be the super nigger baby. (clapping).

So I say to you tonight you black folks we tired of this white racist system and these white racist institution. Thats why black kids on these college campuses

today say teach us black studies. Damn right we not your nigger no more, we want to know who we are, we know our history goes back further than slavery and you know damn good and well that a man without a knowledge of himself is like a tree with no roots. We also demand that these institutions teach you white kids my black history because if you white kids ever learn my black history instead of what your mommy and daddy taught you about me, you find out your mommy come close to being that nigger than me. (clapping). We tired of this white racist system _____

_____ newspaper reporter asked me, Mr. GREGORY, what do you think about black separatism? You white folks shouldn't be permitted to utter the word separatism as long as that Indian is on that reservation. Thats a pure example of separatism, but its OK as long as you doing it. Oh that Indian hold a press conference in the morning say me like reservation, don't want no more white folks on reservation. You would send your army up there tomorrow night and run him off.

Three years ago had I gone around the country speaking that the way we can solve the problem in the black ghetto we need black capitalism every body was sayin that was

racism but that old white board thinks NIXON talks about black capitalism, thats not racism because he a white boy. We tired of this white racist system, its a white racist system that permits my jewish brother to get upset when he found out Black _____ existed in the black ghetto. In fact every jew in America over 15 years old know another jew that hates niggers, now you find out some niggers hate jews. What the hell you so upset about? I tell you what you upset about in the white racist system the aggressor will never permit the oppress to be as sick and degenerate as he is. Thats what is upsetting you in this country. (clapping). I'm so damn glad that the black _____ is out. _____ an ugly _____ because as long as it was here, could nobody deal with it. We tired of this white racist system. You ever see that television show called the Dating Game? You see that ole racists show because if ain't racists because the system is doing it. Anytime a black contestant shows up, the three other guests just happen to be black. (laughing and clapping). But if I had to go to work that show next week and If you found out I said I wasn't going to work that show if you got a white lady on I want three black soul sisters, you would say I was a racists, wouldn't you?

So we saying we tired, tired, tired, of this white Racist system. Everytime I look at my American passport I look at this racist piece of thing they gave me to travel all over. You never got a passport? Check it out one time. Look at those four countries the Americans can't visit, Cuba, Mainland China, North Korea and North Vietnam. You think its an accident they just happen to be non-white communist countries? You aint afraid of communism as long as its white communism and you sick enough to believe that them little non-white commies in North Vietnam is a bigger damn threat to your security then them white honky communists in Moscow, Russia. You got to be sick and out of your mind. (clapping). But all know Moscow, Russia is not off limits everytime an American boy gets killed in North Vietnam, he was killed with a Russian bullet. Everytime an American plane gets shot down over Hanoi it was with a Russian missile, but you ain't mad at them white Russians whose firing after your slaughter, you still bring that damn Russian Ballet over here, you still bring Russian exchange students over here, man the whole world got hip to your game and you run around talking about you trying to protect the world from communism. You trying to protect the world

from non-white communism. We tired of this white racist system. Oh there is a lot of white folks in America that is sick enough to believe to be born black in America you inherit certain criminal tendencies. Say well look at all the, look at the crime rate in Washington, D.C. with the colored folk. Let me tell you something if you took them niggers crime rate in Washington, D.C. and multiply it by ten million you wouldn't equal the crime rate them white folks got up on the hill in Washington, D.C. and you know it. (clapping). Take all the nigger criminals that ever lived in the history of this country, take the pimps, the whores, and the hustlers and put them in one big pot and melt them down to come up with one nigger hoodlum and you still wouldn't end up with one ALFONSO CAPONE, you still wouldn't come up with one FRANK JAMES or JESSIE JAMES and you still wouldn't come up with one BABY FACE NELSON or PRETTY BOY FLOYD or what you call them little ole freaks that freaks out over in the _____.

Little ole BONNIE and CLYDE they your folk heroes, a bunch of damn bank robbers and a bunch of cop killers and you go to movies, freak out over them cause they white folks.

(clapping).

But I would like to ask you youngsters to do me a favor one day next week. One day next week go by the library and copy down the Declaration of Independence, don't read it, just copy it. You know how to copy without reading don't you? (laughing and clapping). Sure you do. Here is the favor I would like for you to do for me. When you copy down the Declaration of Independence keep it with you 24 hours a day, never be caught without, your Declaration of Independence. Here is the favor I want you to do for me, when the riot season opens up again (laughing). Ya this system even gave us a riot season, July through August. This July through August we didn't show up and the whole country got upset, where were you? We had the tanks waiting for you. (clapping). There was GEORGE WALLACE, how come you didn't _____ riot this year? Say ah you know them niggers is lazy and shiftless and they just got tired. (laughing and clapping). I tell you where we was this riot season, we got tired of stealing all of them old bad no good products so this July through August we decided to go underground and study the consumer report. (laughing and clapping). So when the riot season opened up again we aint stealing no more motorolas baby (clapping).

Here is the favor I would like for you to do for me. When the riot season opens up I would like for you to get home, go home with your parents. I'm talking to you black kids to because you got some black folks living in them houses which _____ more degenerate and more corrupt then the Ku Klux Klan could ever think and you do know what I am talking about. (clapping). When you get home I want you to take your television and put it in the middle of the room and then turn on the evening news because they going to show them niggers looting and riding and socking it to the times. Turn on HUNTLEY and BRINKLEY because they get close ups (clapping). HUNTLEY and BRINKLEY get such close ups you can recognize your kin folk. Look at that _____ I didn't know he was in Detroit, get it baby, get it. (laughing and clapping). After you get the evening news on showing them black folks rioting and looting and at that point I want you to run upstairs and get your parents and bring them fools down and put them right in front of the television set so they can see them niggers looting, burning, socking it to the town. While they looking at it I want you to listen to them, listen to their comments, you heard them before, just listen to them and the favor I would like you to do for me after you heard enough of their comments, go up to the television

set and turn the sound off so they can't here nothing
just look at them black folks burning the town and at that
point I want you to get way back behind them fools and
take out your Declaration of Independence and while they
looking at them niggers burning the town I want you to
read your Declaration of Independence as loud as you can
read it and may be for the first time them old fools will
understand what they are looking at. (clapping). We
hold these _____

and all Negroes created equal _____
with certain eligble rights that we _____
rights are destoryed over long periods of time _____

_____ it is our duty to
destory or abolish that government. (clapping). I know
at first them old fools will assume that was some message
MALCOLM X left for RAP BROWN, but I'm sure with a
minimum amout of pursuaian you will be able to teach
them old fools that that was there beloved Declaration
of Independence, that one with the mistake on it, ya that
one where they forgot to write for whites only. (laughing)
Don't you know black folks is dumb enough that if we read
that Declaration without you putting white only we dumb
enough to believe that that met all Americans. We know

its not for us because when we deal with the Declaration they do want to run get their Army like a damn fool. So we would appreciate it if you would get this white board Declaration of Independence out of my black ghetto and then right after you get that out we would appreciate it you get your trampy lily white American history book out of my community because ain't no way in the world you can expect a nigger to behave after reading your history. So you get me your history book that tells me you landed at Plymouth Rock and shot and murdered your way all the way across to California. Now you want to (clapping), now you want to, a nigger behave. You really that sick? Are you really sick enough to believe in still drafting niggers into your Army to say send them to Fort Benning, Georgia and teach them how to be _____ send them to Vietnam to kill foreigners to liberate another foreigner and think that nigger ain't going to come home one day to kill you to liberate his mama. You out of your mind. (clapping). Ya we would really appreciate it if you would get that white board history book out of my community and when you get it out, read it because may be if you read your history you would understand me. Nerve enough to talk about niggers being a criminal in your history

book tells me how you came to those shores and discovered a country that was already occupied. Now who is the criminal? Are you going to discover a country that's not only occupied but being used at the time (laughing and clapping). That's like me and my old lady walking out of here tonight and you and your lady sitting in your brand new automobile and my lady saying, gee baby I really love that beautiful car, sure wish it was ours. I say well baby let's discover it. (laughing and clapping). Can't commit no crime because that's the way white folks got America. Ya your history book is something else. Give me liberty or give me justice, who said that? RAP BROWN didn't he? _____

_____. Don't shoot till you see the whites of their eyes. Ya your history is something else. You got nerve enough to tell black folks we should have respect for the police. Hell when I read your history book I see that you didn't have no respect for the police. It's in there. In the early days when the British was the police (clapping), a white boy by the name of PAUL REVERE rode through the white community and said get a gun white folks the police is coming. (clapping). Ya you sure understand them white panthers don't you? (clapping). You got nerve enough to get upset when the

riots start and the niggers steal a television set and take it home, you want to call him a hoodlum, you still outrageous white boy _____. Tell me how you white folks got on that strange ship and dumped all of his tea in the water. What the hell you mad at us for because we got enough sense to take it home with us. (clapping).

So as I leave here tonight I say to you black folks in America, have an attitude. Briefly let me discuss Black attitudes. Oh we have an attitude and thang God its about time we finally got one. Let me say to you I don't know what it is that us black folks have been doing in America for the last two years to alienate you white folks the way we alienate you, but we got news for you, whatever it is we've been doing we going to keep on doing it. We look around and we see more intergration in the last six months in America than ever in the history of this country. We don't know what it is about your nature and your chemical physical make up that as long as niggers was marching and singing we shall over come the _____ Jesus boy you couldn't get enough dynimite to blow our churches you couldn't assassinate our leaders fast enough, but all it was _____ talking that way no more for,

some reason you behaved it, they gave me a list in America in two years we don't know what it is that makes you behave when we start typing you up, but we got news, we won't type you all the way up baby. (clapping).

We tired of these white racist insults. I hope you white folks understand we got enough sense to know we will never get strong enough to keep white folks in America from insulting us and we hope white Americans understand you never get strong enough to keep black folks from reacting to your insults. White folks got nerve enough to tell us to be non-violent. You know how insulting that is coming from you? The only country in the history of the world that had dropped an atom bomb on another human being. Go out and drop your napalm every morning on women and kids and then walk around telling us to be non-violent youth, you got to be joking. White folks in America shouldn't never be permitted to use the word non-violent as long as your indian brother is on that Indian Reservation because you can't be no more non-violent than the Indians have been in America for the last 75 years. What happened to your appetite for non-violence. See non-violent is nonthing but a cheap whitey _____

Oh if that Indian wants a better way of life in the morning he got to realize he is dealing with such a racist insane nation that till you make this country _____ muzzle of a gun she is going to keep your nigger. Oh that Indian wants a better way of life all you got to do is get out on the _____ tomorrow or Monday morning in Arizona and catch white folks driving down the expressway and start shooting at them, Pow, and yelling red _____ whitey go home when that Indian tells you to go home he talking about the big trip baby. (laughing and clapping). Just as sure as that Indian is going to raise hell Monday morning I'm just _____ Monday night those stinking reds. As long as that Indian is kept running up that reservation and looting and burning, getting him some blonde sclaps and raping some of you white ladies, Oh you listen to him then, oh it would upset you but you would listen, Oh you know that the Indian raise enough hell this year next year you would have a Indian here talking to you. (clapping).

I say to you youngsters there is a sad comentary on America. You youngsters got to create an atmosphere in this country where America will become as ashamed of injustices at home as she is afraid of communism abroad.

You got a big job, you got to say a man can march and demonstrate and re-address his grievances and don't need a fire bomb.

So I say to you tonight we tired of these insults. We tired of non-violence nobody knows how insulting that word is to me because I'm one dedicated to non-violence. I had to become a vegetarian because _____ shall not kill as far as I'm concerned means animals to, but thats my hang up. Non violence is my thing now. I don't go around teaching non-violence vegetarianism my thing. I would never knock a steak off your plate. I will never let you put one on mine. I will never tell you about how you suppose to behave or react. All I can say to you about my life I would find more pleasure in being killed by a man than killing a man myself and I hope somewhere down the line (clapping).. I hope somewhere down the line you youngsters in America create an atmospher where man will have to solve all of his problems sitting at a table and not with a pistol in his hand. The word non-violence I don't even like it anymore. I would like to see you young folks develop a new philosophy. Damn non-violence, develop a different philosophy. I will not violate you, thats the new philosophy. I will not violate you and you will not violate me. You can hate me and I can hate you. We

dedicated to not violating one another and my hate will only affect me and your hate will only affect you.

You youngsters got a big job. All we saying is we tired of these insults.. A lot of people come to us now and say, How come we can't call you all colored no more? How come you all don't want to be called Negro? Let me be honest with you. You can call us anything you want to call us. I'm just saying its safer to use the word black. (clapping). We don't mean to put you white folks in no imposition but we looked around and we noticed you don't play no games with yourself, why play them with us? But you leave Isreal today to come to my country. Here is a Jew in Isreal, he stays a Jew when he gets here. I'm going to tell you to leave Italy to come to America, he is an Italian over there, he stays an Italian when he gets here. The jolly ole Irish leave Irishman, they was Irishmen in Holland and when they got to America they stayed Irishmen. We looked around to see you haven't played no games but yourself, why do you insist on playing them with us when we both made the same trip across that Atlantic. We left Africa and when we got here we got to be Nigras and _____

and colored folks don't play no more games with us.
Call me colored nothing you want to play some games,
call yourself clear folks. (laughing and clapping).

So as I leave here tonight I say there is a
new day in America with Black folks. Twenty to
thirty years ago black folks in America had an empty
stomach, today black folks have a full stomach but
a hungry mind. A hungry mind will not tolerate the
same thing a empty stomach did, empty stomach deals on
_____ and hungry minds deal on sound and all at
once this country don't sound right to us anymore.

Five years ago four white boys burned up
their draft cards and in two weeks time the Senate
and Congress had passed an anti-draft card burning bill.
We haven't been able to get them to pass an anti-
lynching bill in a 100 years. (clapping). When America
passes anti draft card burning Bill but will not pass an
anti lynching bill my country just said it to me that she
thinks more of a piece of cardboard then she thinks of
my black mama and I well bring her to her knees for that.
(clapping).

If I was in Vietnam right this minute and got killed by a Viet Cong this country would give my black wife \$10,000 and she couldn't take that \$10,000 and buy herself a house in any neighborhood in America she would want to buy here, hell I got killed shooting at the wrong folks. (clapping). The only insulting thing if I got killed in Vietnam tonight and a red

_____ Mississippi racist white boy got killed with me, the Vietcong would push both of us in the same grave and bury us together, but if our dead bodies were shipped home we would not be permitted to be buried in the same cemetery in America. Its a sad day in hell when I got to stand up and admit that my enemy can treat me better dead than my country can treat me alive. (clapping).

So we say we tired of these insults. Stop and think America say well you all get a fair house _____ get a fiar house and live only where in my country, I want to live. What kind of animals are you? That old _____ Russian _____ STALIN's daughter, known communist and a known Russian, you ain't suppose to like neither one of us. You didn't

make her get no better housing bill to come to, come to my country and live anywhere she wants to live. Why in the hell do I _____? _____ Russian exchange students that comes over here, they don't want to be your citizen. Matter of fact you got to watch them for four years so they don't steal no secrets. You don't make these Russians _____ exchange students get no fair _____ bill to come to my country and live anywhere they want to live. These ole _____ why do we need them? We saying we tired of these insults. Oh there is a lot of white folks that believe a nigger is the stinkingest, smelliest thing that walks the face of this earth. Thats a _____ hang up as long as you keep it in your head. I'm not here this evening to convenice you that niggers don't stink. I say do your own research, (laughing and clapping). You better check the records at the college industry and see how many _____ billions of dollars a year you white folks in America spend on deoderants. (clapping). _____ them deoderant commercials on television, see if you ever see a _____.

Just figure it out for yourself, black folks is doing all

the drinking and white folks is buying all the deoderants,
who really stinks in my country?

So we saying we tired of these insults, oh
there is a lot of white folks believe because I was
born black I'm inferior to them again I say _____
hang up as long as you keep it your _____ the
_____ thing to say _____ is
to tell you I'm inferior to them because I'm black. I would
be the first one to tell you that if I was _____
leave tonight with a Japanese girl _____ Jewish women
tell you _____. I could go to bed with
any one on the face of this earth and give _____
be the first one _____ baby going to be a
nigger. My sister can go to bed with anyone on the face
of this earth and _____ the baby going to be
her _____ inferior stop _____.

We saying we tired of these insults and all we
doing is reacting _____ while white folks
tell us that education is our problem, that ain't nothing
but _____ white _____. Hell if education
is our problem, the jews would _____ this
country. (clapping). _____ the problem how come

you got _____ in Vietnam cities _____
_____ school teachers. (Clapping). Education is
the problem, then how many of you has wondered who was
_____ millions of people would be dead _____
_____ on the face of this earth _____
blood plasma. Are you aware of the fact that a black
American by the name of _____ invented blood
plasma? Don't take my word for it, check it out in your
library. Are you also aware that _____
_____ waiting room after _____
accident cause they _____ except niggers.
Education _____ my problem, the man with _____
knowledge to give blood plasma to the entire world, died
from the lack of his own blood plasma in America _____
_____. Damn thing _____
with it. (clapping).

So we saying we tired of these unsults. All we
have to _____ black women in America have 20 per
cent illegitimate babies we not going to _____
ghetto baby. (clapping). White women in America have
two per cent illegit. We tired of these insults you
little white boys want to run around because your white

sister got two per cent illegit and my black sister got 20 per cent you want to put halo around your head and make yourself believe that morally and spiritually you better than I am. No baby if we ever get our hands on you white folks abortion credit cards we will show you how to knock a rate down. (clapping).

We saying we tired of these insults. White folks come to us and insult us, How come you colored folks have all them babies in the ghetto, you can't take care of them? We know that. We make a deal with you today this white racist system learn how to harm black boys and give us good jobs like it gives you white boys so we could afford all them whores and prostitutes like you, we'd quite having all them babies _____. Now we don't have to ask you about that whore because it is my sister remembering she do talk when she comes home, so we do know what you doing.

So we saying we tired of these insults. When I stope and think that that German kill my daddy during World War II, had a German killed my daddy in 1942 I was 10 years old, I'm now 37 years old, now that means I would have gone 27 years without a daddy which is no insult because when daddy's go to war, they go to kill or be killed. The insult is the same

German that could have killed my daddy during World War II in 1942 and made me go 27 years without a daddy, that German tonight can come to my Daddy's country, and live in the neighborhood that my Daddy's boy can't live in and you all make like you all don't know what we're talking about. We're saying _____ before we ever sit back again and watch you treat your enemies better than you treat your citizens, we will burn this country down to the ground. That's what we're talking about.

So tonight as I leave you I say no more games, no more civil right legislation, we don't want our rights on no civil rights. We want our rights on the same piece of paper you get yours one. No, No, I take it back. We'd like for you to play one more game with us before you quit. We'd like for you to get together and give us what we call a honest white folks deal. Don't none of you get up tight cause it ain't got nothing to do with white folks. Matter of fact we'll give it a good name, we'll call it the Concerned Honky Law. (laughing). Oh I'll bet that will go over big in the ghetto and it will just be a simple bill that reads all five year olds, black male baby boys, haven't got nothing to do with white folks, matter

of fact it don't even cover my black sister. All five year old Black male baby boys will be forced to go to a government camp for one year from the age of five to six. Will also stipulate in this law that those black boys will be able to sleep for eight hours a day and for 16 hours a day for a soild year the government will teach them and thats where the honest white folks come in. Sixteen hours a day the government will teach them little black boys, nigger when you grow up don't never fool with a white lady, don't never date a white woman, don't never go to bed, and let me tell you something before we leave here tonight we can not believe that nothing upsets you no more than to see a nigger with a white woman and you ain't got guts enough to talk about your number one hang up. Just who in the hell do you think you are? One day if you ever get up enough man hood to talk about your number one hang up you might find out its something you doing to make us want that broad if you ever have enough sense to quit doing it you find out no body wants that white woman but you (clapping). But the mistake you made with me everytime your new cars come out you can't help but drive a new car without that white woman so I feel I need me a white lady to make my gears shift right, O.K.? (clapping).

I am sitting on that airplane the other day reading and minding my own business looking at a Life magazine getting to page 35, there big ole picture of a white woman with a big bottle of pepsi-cola in her fist talking about thristy honey, have a pepsi. Ya I'll have a pepsi, you to you ole white broad (laughing). I go home to my black ghetto, walk into my black house and get in my black living room with my black wife and my black kids and turn on my black television and there your white sister running across half naked talking about my playtex living bra. Ya you damn right I'll buy a living bra for my old lady and I'll buy you some meat. You know this might come as a surprise to many of you but you know niggers wasn't born wanting a white woman. All my life I've been told the most gorgeous thing God ever put here on the face of this earth is a gorgeous blue eyes blond white woman and when I get ready to check you out cause you know I ain't going to take your word for it, he wants to get upset.. I went to see my first movie I was four years old. I didn't know nothing about no white lady. Never see no body making love in my life, four years old and my mind was pure and ready to be prograded. I couldn't

even go to Downtown fo the white movie I had to go to the black movie and you sent that white woman out to my black movie just what in the hell did you have on your mind? Four years old, who I see making love, AVA GARDNER and ALAN LADD. I didn't know what they was doing at four years old, but I had enough sense to know one day I was going to grow up and do it, I went to movie every day. Next thing I knew I'm eight years old and been going to movie everyday for four years looking at that white lady make love. I never will forget one night, I was eight years old, AVA GARDNER and ALAN LADD (nothing on tape). (clapping).

The mistake you made with me was _____ only black woman who even showed me in the movie when I was being programed was BULAH. The only black woman you let me see advertised _____ your mama and for some reason I just thought you white folks were hip enough to know that I ain't never ever in my life wanted to make love to BULAH nor Aunt JEMIMA (clapping).

So as we leave you tonight I tell you you youngsters got a big job, you got an important job changing the system. Let me say to you young white kids tonight thanks for changing the civil rights movement into a human rights movement before you made it a human rights

we never talked about the Puerto Rican brother, the Mexican brother, the Indian brother across this country there are white kids that has never seen a Mexican in their life other than on television and in the movie. For two years now they have been standing in front of their supermarkets holding a picket sign saying don't buy California Grapes. Its a hell of a movement, its hell of a tribute to you young kids and you won that Mexican boycott up until 9 weeks ago when tricky DICK NIXON bought 89 million dollars worth of California grapes and shipped them to Vietnam, most of the people in America don't even know he did that, but he did. Next year when the Mexicans start blowing up the grape vineyards let him sell the dirt to Vietnam. (laughing and clapping). Le me say white kids got a movement and you young folks got a movement going on thats going to solve all the problems, but to you young white kids let me tell you you making one mistake for the first time you talking about the black problem, the Mexicans problems, the Puerto Ricans problems, the one mistak you making and I hope you'll quit is a boy, white hill billy brother of yours in this country that up till now nobody gives a damn about. I hope you include your

movement to cover that poor white boy to. (clapping).
I hope you talking about a movement that is going to
wipe out hunger in America regardless as to what color
it is. I hope somewhere down the line you find some
concern for that white hill billy brother of yours when
you get down in his ghetto and get the _____
to his kids so they can come to these colleges and
universities to. You got a big job. You know a lot
of people write me for tapes of my speeches and ask me
do I have it printed, well I am very happy to inform you
that not only is my lecture record which is called Hit
GREGORY's Light Side and Dark Side, has been on the national
chart for the last six weeks, but that aint no big threat
to the Supremes or nothing like that but (laughing) but
TINY TIM had better watch out so those of you that are
interested in lecture record its two albums record in one
package about an hour and fifty minutes so if you interested
you can pick it up at record shops. Let me say that those
of you that have to get to work and those of you that got
babysitters to relieve we going to take about a three minute
break so those of you that have to run can run and then we
will come back and deal with some questions and answers, but

right now let me say to you youngsters that thank you very much for October the 15th because I got seven little kids at home in Chicago that I'm sure after October 15th that you is going to make this a better world for young folks to grow up in so let me personally as a father say thanks to you and hope you keep on doing what you are doing and God Bless Nature, have fun. Good night. (clapping).

On behalf of the associate students I want to thank Mr. GREGORY and we found a red purse here we would appreciate who ever lost it to come and collect it, thank you all for coming here. (clapping).

If you think its stupid or you think its silly so I would really take it as an insult that if somebody asked the question regardless of what you might think the question who hiss them or gible, if its funny and it deserves to be laughed at, I'll start to laughing off first, O.K.? hahahaha, o.k. At this point we ready to entertain your questions. Yess maam, would you stand up.

What I think of your Governor REAGAN? (laughing)
Well I don't know if it ever dawned on you lady but are you aware of the fact that REAGAN spelt backwards is nigger (naggar). You slow readers figure it out sometime tomorrow. (laughing). I was kind of hoping he would behave himself so

he could get elected to the presidency of the United States so we can boast we got a backward nigger in the white house (laughing and clapping). Now let me say this about your Governor. I think that California is probably moving further ahead today in dealing with your problems then ever in the history of this country because you have a REAGAN in office today but this _____ didn't happen with REAGAN. It was here during the whole PAT BROWN administration and them cats never dealt with it. They never touched it, REAGAN didn't say we was going to have segregated schools in California, they was segregated before PAT BROWN got in and as liberal as he was he never did anything to intragate them so at least REAGAN is in and everybody seemed to rally behind so I say give me more REAGAN maybe we can get it over with in the morning. The same thing about BARRY GOLDWATER, only problem I found wrong with BARRY GOLDWATER was LBJ and he was honest. (laughing and clapping).

Yes brother?

What would I do about the draft. Well lets assume that I was the President of the United States.

Oh you mean if I was 19 years old what I would do about the draft? Well its very difficult for me to suggest that because you know they got laws now that say I can't stand up here and suggest that, you know? hahaha (laughing and clapping). It might get me in jail but it damn sure won't be in a crowd of people thats infiltrated by the FBI and CIA. He is telling you what he is going to do with the draft, let me say this personally I think number 1. You got to live up to your own convictions and I think somewhere down the line ah if you decide that you not going to kill, that you shouldn't kill, now personally I believe every country needs an Army to clean up after earthquakes, after a tornado, after a flood (clapping). So in all sincerity with this principle in mind if I was 19 and got drafted and thought the way I think now I would go into the Army on one condition that they would send me to the front line immediately without a gun because you know whats going on in America now. I can truthfully say America is worth dying for but I ain't never in my life worth nothing worth killing for and if it is I'm sure going to be that Mississippi Sheriff that kicked my old lady in the belly when she was nine

months pregnant before it ever be some Viet Cong so I feel, thats my hang up. I don't believe in killing and I would be willing to go to the front because I think a country should have an Army to do things with you know I don't mean to be killing but I think America is in that kill bag the rest of that world is in that kill bag, we are not going to wipe out the army overnight. I think what we got to start doing is working on a long range program to do away with not just Armys here but all over the world I think that before We can every consider of talking about living in a world with no hostility and where man is not going in for some cheap phoney manhood we got to first start talking about feeding people all over the world and we strong enough to do that. We rich enough to do that, to see to it that no man has to go to bed hungry. Now you know if people all over the world go to bed hungry tonight because there is no food they have one attitude, but if they knew it was food, but them government officals wouldn't let them get the food, man them government officals would be in trouble because this is different thought a mans mind knowing there is food but the folks just won't let him get to it. So I think, Number one, we got to talk about feed people. Number two, we got to talk about sitting up a whole

world wide medical program, and its a damn shame we got a cure of vaccine for polio in America and we haven't distributed it all over the world. I mean what difference do it make what the kid is, there is no such thing as a communist kid _____ do admit you know we got a cure and we haven't spreaded it out all over the world. I'll tell you whats funny, I was in Moscow, Russian this summer, my wife and I and we was just horrified over the fact that we will not share our medical advances with everybody and the communist won't share theirs, but you know there is whiskey all over the world. There is dope all over the world, prostitution all over the world, there is cigarettes all over the world, ain't nobody _____ you not going to drink my _____ because thats communistic inspired and the Russians say alcohol is capitalistic habit. _____ man alcohol and all the bad habits is all over the world, anything that would hurt your health it has no hassle getting around the world. But when he talk about up lifted and keeping a man healthy, then we get into these political hassles, so I again I say three things, food program, medical program and the third one is an important one, see to it that we work to ban capital punishment all over because when man knows his

State will not kill him, he takes on a different behavior pattern. So In think those are the three most important things, fourth is controlling this thing at home and you young kids _____ going to have to build you an independen t political force you can talk about that democrat and that republic, the democrat and republican party is to immoral, to insane to rule you youngsters. Now you talk about that stuff you going to join it, change it, thats like you going to go into a lions den and put a diaper on him. Believe that if you want but you are going to go into that old lion and that lion is to slick baby to have you run in there, he will eat you up alive, so if you youngsters can move into an independent political rank even if you going to vote democrat or republican, register him and get your independent movement going and put up a black form where statesman can run. Now we keep telling you that you ought to come in the system, well you young kids thats to young to vote, you ain't got nothing to do but stand out side because you the one thats dying. _____ RUSSELL's son been out of college five years and ain't never left Washington, D.C. DUPONT's boy and _____ boy ain't none of them fools goint to no war getting killed and if any-

body should die they got a whole lots to die for
_____ because they own it all, so some kind of
way you know that when we keep telling you youngsters
to move into the political arena, we trying to trick you
in there. If you looked at the elections in November and
looked at the returns coming in man, its a damn shame man,
here we put astronauts up in the air or on the moon so they
say, I don't know where they sent them, but I have my doubts
about America, she can't feel a safe _____ or want
me to believe she went to the moon, you know. I don't know,
you know, may be she has, may be she just thinks that about
people down here, but when you sit and look at astronauts
out in space we know what his pulse rate is, we know what his
conversation is, we know what his temperature is, we know if
he feels bad, we know if he sneezes, but yet still in America
it takes sometimes two days to count the votes. Now you know
that these sick degenerates you give them two days of counting
votes and it ain't going to do you no good to vote. You
youngsters got to talk about a political system where America
immediately goes out and electronic all the polling places so
when that polling place closes at 6:00 o'clock, one-tenth billion
of a second that electronic polling booth will count that data

and you don't get _____ fools time juggled them votes and put in who they want to put in regardless as to who won. Now its very interesting, we did a little re-search in Chicago and we found out that in Chicago to have an election in Chicago it costs the citizens of Chicago a \$1.87 per citizen of Chicago thats what it got for them to hold a election. If we had electronic polling places in Chicago it would be 22 cents per citizen to hold elections, not only is this cheaper its more convenient and millions of dollars we spend storing them being bulky voting machines, electronic voting machines wouldn't take that much space, so there is all types of reasons why we should have electronic polling places, but this system can not afford to get a fair count because then they don't have ways of jumping it their thing. Now once you youngsters can get into their political game from independent standpoint then you got to start working on some hip _____. You got to talk about war, you know damn good and well this country ain't about to get out of that war game in the next 30 to 50 years. So now you got to paralyze as much as you can, you got to start pushing bills through that says anytime America goes to war the industry that makes war material by law can not receive more than two percent profit more during war time then they receive during

peace time, then you take that profit out of that war game and there would be a whole lot of them folks not won't be interested in wars then. You got to pass laws that say any time in America that an American soldier gets killed in hostile action now if an american gets killed we get \$10,000 this is the same thing we gave them in World War II which means the only thing that they haven't increased in value is a dead American soldier since 1942 and so what you got to do is pass a law saying every American that gets killed in war in hostile action this government will not only give their familys \$50,000 cash immediatly, but that family becomes the ward of the federal government for the rest of their life and then when you start talking about putting a price on that war game baby, then you had _____ you would be surprised how good peace tables will look to them over there on one of them battle fields. (clapping).

The question is, she is interested in the hippies that reject the system and drop out and the question is am I asking for staying in the system and not drop out? No I am not. I think you know the most beautiful thing about hippies I wish more black folks could be as beautiful as the hippies, they don't get involved with the civil rights movement, but

they always making comments against what is happening
there is one beautiful thing about the hippie, he drops
over there and he leaves it alone , he don't play no games
with it, so he is no problem, he is no hang up, you know
you can't run and put a camera in front of his mouth and get
him to put down _____ DAVIS or nothing like that,
so I think you know a man got a right to say you know I want
no part of it, you know he got a right to believe than no-
thing can save this system you know he got a right to believe
I mean thats human nature you know they say a rat needs a
ship three days before it sinks, but where did he go out
there in that water and die three days earlier. (laughing),
but ah I think you know for some reason we might can save it,
but If I had to bet, be honest, if I had to bet tonight
could we save the system I would bet that we couldn't, thats
from where I stand from the research I've done I don't believe
we favor system, but I think, I got enough faith in young kids
that may be you might slip through, but you see you got to many
bad fractures facing this country today. You got the one frac-
ture that the system might swing these young kids into that
far left bank, we _____ into the far left bank this
country is coming down to the ground or we might get a _____
with the CIA over-throw the government because they would see
which way it was going, I think the likelihood if we going to

get over-throwing the government within the next two years. I think the last election that we had in this country as far as I can see it I think it would be the last election on this, you know unless something very drastic happened cause when you look at the CIA we've let this monster get out of control. I don't know have you been following this case of General TURNER, about these guns _____ does it strike you funny that nobody in Congress asked him are you all familiar with _____ strike you funny that they've been holding that investigation for two weeks and nobody asked him who he sold the guns to? He sold the guns to the CIA _____ whole big stink. I don't know if _____ hip enough to know what he is doing and kind of scared and want to slip it out easy or I don't know if they just trying to cover it up, but you know damn good and well man that as many guns as that man has been selling somebody got to ask the question. That's whats wrong with this sick degenerate newspaper in this country, not one newspaper reporter has asked who did he sell the guns to? Ya whose bought them? Somebody had to be buying them, the CIA is buying them. Hell did you see what happened with the Green Berets trial? They had to cancel that murder trial because the CIA is not going to testify if the President of the

of the United States involved in the murder trial he got to testify so if the CIA don't have to testify that means they are the president, ya its just a matter of time, thats what MALCOLM X meant when he made that statement that upset everybody, when KENNEDY was assassinated. He said, the chickens is coming home to roost, you know he was hip along time ago because what he was saying is we paid that stinking stupid CIA big money to go all over the world assassinating leaders and toppling down governments now they coming home to get ready to do the samething with yours, and thats the way I see which way its headed myself or they might push these kids into the far left. Now let me explain something to you about the far left. America do not now anything about the far left, only thing she knows about is the new left, the right wingers try to make the new left believe you the far left, the right wingers going as far as they can go to the far far left is much more vicious than the far far right could ever be and if this country ever gets pushed into a far left bag you might as well pack your bag and get out of this town, get out of this country cause see any time the far right gets ready to kill me they hold a meeting in some ole smoked filled room _____ the money. (laughing). Then one day I could be standing

here talking to a thousand of you, I could be with my wife, I could be with my kids, I could be on a balcony like KING was, I could be in a bubble top car ain't nobody going to die but me, thats when you the right put the _____ down. The left decided I got to die, they hold a meeting, how we going to get him? He goes to the football in

_____ lets blow the stadium up (laughing).

So I think thats why I say to you youngsters you really got to work fast its not to late if we haven't gone beyond the point of no return but to finalize your question, I have no _____ one way or the other about _____

_____ they got out of there they stayed over its really, but let me say this I hope, especially you young fellows, you know that everytime we have a peace rally there is sometimes more women out there than men, you know the one thing the women don't have to worry about is going to war being killed and somewhere baby we can say thanks to them for the first time by seeing to it after we get this smoked cleared and start cleaning up this system see to it for the first time women will start getting their rights in this country which they've never had and which we keep putting things ahead of them, we keep talking about everybody's thing except their

thing and some kind of way I hope you young women you know get off this ole silly womens attitude thing and start asking a whole lot of questions you see because there is no woman in America thats going to _____ make a position to put America in war but when these old fools put us in war we come back and get your babies, when you young women start teaching your baby at the crib that you did not bring him in here for somebody to stick a gun in his hand and for him to go around shooting at people then thats the day us old fool men we ain't going to quit fighting wars but we going to find another way to fight them cause you see when you can't get people we can fight a war with a chess game, you know, winner take all which is _____.we _____ . I'm not dead, least all I got to do there is learn how to speak Russian. (laughing). But somewhere you girls got to ask a lot of questions somewhere you young fellows cause I think us old folks is to committed and to sick in our heads to look at a woman as keeping her in a place, but I figure you youngsters got to shake that thought off of your head, you got to see to it that she is a human being first and a woman second and qualified to get all the rights and benefits of any human being regardless that she wears a skirt, not, I can't stress to you young ladys that a lot of

questions you got to answer a lot of questions you got to challenge you know, I don't know how you women let us put you up on them high heel shoes, hell if high heels were good for you, we would be wearing them (laughing). We never had anything out here that we didn't wear that wasn't good for you because how silly it looked, you know well that cause we _____ pocket books is pretty hip but now youg cats getting them ole big purses now, hanging on them, you understand? Keeping pockets free so can understand how these world wide conferences all these old men get together and talk about the worlds to over populated you know, and after they get to talking about it they run out and buy some whore in the corner, they talking about how over populated the world is, but they ain't doing a damn thing to stop it. Then after all the men get upset about how over populated the world is I have never met a woman that is upset over population explosion is noting but men and after we get upset over it we make you take the pill, now you got to be stupid. I mean it takes two to tango baby. If that pill was any good we would be taking it and that birth control pill is one of the dangerous and most dangerous thing that man has ever invented. Its more danerous than the atom bomb believe me because least every-

'body is hip to the atom bomb. Any of you know how, raise your hands if any of you know how _____ birth controls are made out of, anybody? You know they made from male horse sperms, thats right, horse sperms under the theory of nature is so beautiful you can't trick nature, you can not put all in water in a glass and mix it, it will not mix this sick fool decided that a horse sperm and a male sperm in a woman's body would not mix it, thats the principle the way them damn birth control pills work. I don't how many of you, let me ask you to raise your hand, any of you familiar with any of you ever been around a man that has been taking cancer treatment where they give him female hormones, have any of you? You know the way his breat develops just like a woman, well thats the same thing that is happening to women with them horse sperms after about three or four years of you using it _____ start getting big like a horse. They, and its not really funny, its dangerous man, their belly starts dropping like a ole horse and the government already knows that in (laughing). I guess about 15 years of using them things a broad won't be able to sleep unless you put some horse manure under the pillow. (clapping). Hay man where your lady? She outside racing around the block, you know

above and beyond the human point'. I sincerely hope that you women, you know, do something about what we doing, in my book and I don't say this for you to buy, check it out of the library, write me and did any of you ever read 'Write Me In'? You see the point I dealt with birth control pills now I wrote that book two years ago, long before anybody in this country ever started talking about the harm of birth control pills, cause we was able to get hold of a government research paper from the surgeon generals office where the government, the federal government been know for ten years that birth control pills are going to be fatal to 98 per cent of all the women that use them after _____ didn't know it _____ but they still refuse. England, London, England is taking them off the market and you know what they used to take them off the market this government report here _____ they made them take birth control pills off the markets so I hope you women would start checking on these a little bit more and you see if you women ever wake up you see the burden is on you to do a whole lot of thinking, you know if I had been elected president of the United States the first three things I would have bombed would have been Kelloggs, General Mills, and the baby food companies. I don't

think there is anything _____ killing people in this country no more than this ole _____ food and for some reason you women don't care. Baby food is the most disgraceful thing in the world and this is the way baby food industry works. They know that it is human nature for a mother to taste food before she gives it to her baby so they mess up that food making it to your taste, they put all that salt, all the _____ they put all that seasoning in it and a baby don't need all that stuff, hell baby system not used to that, but they know damn good and well if they don't put it in there you get to _____ this don't taste good and so to keep you happy you know these baby _____ is coming up beginning from the you know right from the crib with bad food because you know these food companies you know we got to have some laws against food, they talking about the automobile industry no 99 percent of every sickness in this country is caused from the dye and if we in this country especially you young kids ever learn to dye, go to the health food stores. I don't know if you have any in a small town, but get to a big city and go to the health foods and books don't cost nothing but a \$1.00 and read and learn that was the success of the early Romans and the Greeks that still have pyramids, still have books, a theory that

we still marvel over and there success was one baby learn the human body. That was the first thing they did, and after that they learned how to eat, now these old fools got you talking about you got to have protein, you have to _____ hell we didn't know nothing about calories 50 years ago and what in the hell was them people using many way back then in the Roman Empire, the Greeks that mustered them mighty Armys and that didn't have no machines, what was they using? So some kind of way if you youngsters really learn about food and learn about the body and challenge all of these theories right? Everytime you go to the store pick up something that says _____. How in the hell are you going to improve on nature? Hell you going to _____ and anything you read that saying enriched on it you know that food tampered with it baby, and the government got some old _____ law that can say after you tamper with it over here you can put enriched on it. Do you know that if you take pasteurized milk, Any Farmers in here? _____ do you know if you give pasteurized milk to a cow it will kill it. Ya damn right you know _____ all the reason they make the farmer pasteurize the cow because they know the farm in America is to unethical to get rid of a

cow that has T.B., and if you take milk from a T.B. cow you going to get it so they make them boil the milk to kill the germs when they kill the germs they kill everything else in it and thats what they got on the market so somewhere down the line you youngsters really got to learn about that body and really got your _____ out you need protein, hell cow don't need to drink milk to produce milk you can get. the right amoung of minerals in your body, your body is going to produce all the protein it needs, but somewhere you younsters got to learn about buying nothing _____ this old way we teach you in school and they ain't teaching you nothing in school. As rich as this country is man, can you imagine we the richest nation in the world in health wise and the men in America rate 16th in the world and the women in America rate seventh in the world health wise so evidently we doing something wrong and its very funny you know the only sad people in America is poor folks and _____ and ole fat KENNEDY cat gets the money he learns how to eat right. I guess the poorer you are the more you want to eat, the more you eat the richer you feel, but all you doing is killing yourself.

O.K. we got time for another.

Yes brother?

The question is ah talking about the bills I talked about am I asking to elect more young legislatures like JULIAN BOND, JULIAN hate me for saying this cause we very good friends, I do alot of engagements for him and he do alot for me, but I love JULIAN BOND and I would die for him in the morning. I don't trust no democate or no republican and JULIAN BOND is a democrat right? Thats the same party WALLACE belongs to right? Thats the same party _____ belongs to right? And so I don't trust _____ and I think if they are as pure as I believe JULIAN is then they should have the convictions and the courage to get out of that filthy slimy party and come out and get an independent political movement going where you would rally behind him with out rallying behind that democratic party but there is no way in the world you can put JULIAN BOND in the Presidential office as a democrat without him helping the democrats and he couldn't go in there and sweep it clean because everybody say well you know we gave you the money you got so be careful, you see, look at SCOTT. SCOTT from Pennsylvania that just got DIRKSON's job _____ he is one of the most militants going until he got that job, now look at home, he made a complete

turn around so the democrat and the republican party
is you see my feeling is that the lowest animal that is walking
the face of this earth is the American politician and we
need statesman. (clapping). And the democrat and republican
party will eat up statesman, I mean they proved that with
FULBRIGHT. FULBRIGHT is one of the most brilliant minds
in this country that this country has produced in our time,
he is morally dedicated and ethical _____ most
beautiful dialogue he brought out on Vietnam, nobody has
ever brought that dialogue out, but when it comes time to
~~vote on the civil rights bill he had to vote against because~~
he had to go back to Arkansas and run for re-election. We
in trouble, man, we got a system that just chews up good men
and makes them dogs, somewhere you know, what I'm saying is
you youngsters got to get up a new independent political party,
you got to refuse to participate with that old thing _____
_____.

Yes lady?

Am I planning on running for President in 72? Well
let me say this ah, in running in 68 I sit at home and I knew
~~what the odds was of me getting elected by a trillion to one,~~

but I still _____, I still could have made it you know, to me the rich boy is running this country might have said DICK, if we put him in office we can save it you know cause black folks are brace, right? So they could have tricked it and I could have been the President, you know, but I then got to wondering as I was looking at the returns you see the first percent that reported was a black percent in Chicago and I was ahead for a few minutes (laughing) scared me to death, I told my wife, I said baby you know if I win this election that wouldn't be hard to do, the hard thing would be to get from Chicago to Washington, D.C. alive. (laughing) and _____ everybody in the world would have called me a racist because I would have stayed alive, you see the way I would have to do it people would have swore I was a racist, see I would have hired nothing but all black folks in the capital and all black employees, not only black but they would look just like me, beard and all, then bring on your assassin baby I can just see him now, that minuteman getting to draw that _____ and then report _____ boss I just assassinated President _____ man I am looking at television _____ made you kill (laughing). I don't know, I would hope I wouldn't have to run because just,

let me finish, I'll get to you. I hope I would not have to run in 72, I would hope that we can develop some statesman that would come forward and be able to run.

Yes maam?

Peace and Freedom Party was EUGENE MCCARTHY, no, well can I be honest with you lady? There is a couple of questions EUGENE would have to ask for me before I would run with him on even participating or even voting for him, he would have to explain to me how he voted against TEDDY KENNEDY, to come to _____, that's one thing he would have to explain. The other thing he would have to explain is, now he might could explain it he would also have to explain why he gave up his senate seat to a honk _____ the commissioner to a honk and then the third and important thing he would have to explain to me you know why his name is in Who's Who in the CIA. _____ that book that came out of East Germany that's a factual book that we will not let in this country that's one of the best sellers on the face of this earth and if he could explain those three things to me especially why his name shows up on the CIA book and then we might could get together, but those three things and the CIA thing he definitely will have to explain to me whole lot.

I've talked to some people close to him and I mentioned it and I was surprised they was honest enough to say he used to belong to the CIA, but as far as I'm concerned the CIA is not something you used to belong to, you know.

Thank-you. One more question and then we going to _____.

Yes maam?

_____ question is I ran for President with MARK LANE as my Vice-President, never heard a thing, didn't you see his picture in the paper the other day, ya his picture is in the paper, he is in Denmark. What was it _____? I don't remeber the story now. I don't know if he was going to defend some draft resistors in Denmark or just what it was but _____ he called me before he left the country, he was going to talk to North Vietnam in Paris but then HO CHI MING died and I never did get back to him because I figured _____ all be at the funeral, but he is in Denmark. He should be back in this country oh, about sometime before Christmas, but he is fine, there is one cat I don't, know why they haven't killed, I know why they haven't killed me, but I don't know why they haven't killed him, cause he is the first one that kind of let the whole world that _____

the Presidents assassination didn't go down the way it went down, you know he was the first one that came out openly, a lot of people thought the CIA killed the President _____ and to this day I don't _____ still that other thing you know, they might feel they do more harm by killing _____.

Yes Brother?

Why did the CIA kill the President? I don't know I don't work for them _____ (laughing). No let me say this, ah it goes all the way back to the yale professors that was busted for spying in Moscow, Russia, do you remember and that and KENNEDY was ready to go to war and KRUSCHEV said that little boy don't even know who is running this country, so they let the yale professor go and KENNEDY had strick orders to pick him up in the plane and bring him right to the White House and KENNEDY sit down _____ asked him are you with the CIA? Well the professor though he _____ he say, yes sir, he said it just bugged KENNEDY so bad because the CIA denied it. KENNEDY was really going to go to war over that deal _____ because he really thought that KRUSCHEV was really just picking on a intellectual and when he started getting bugged with this

and _____ says well you know I got some traveling I
got to do I deal with you all when I get back, he said O.K.
Sure will. He said the interesting thing about America we
so silly that we dumb enough to believe anytime a cat _____
_____ let me tell you something _____ our
security is so tight ain't no _____ kill the
President, but if my _____ assassinated
tonight with no _____ believe you _____
the cat didn't like the system, we can never look at these
_____ political years, you know, I can _____ why
they assassinated _____. Dr. MARTIN LUTHER KING
was assassinated _____ pulled off by the CIA.
The best one when you _____ that one then you under-
stand we _____ assassinate MARTIN LUTHER KING for
no reason and to get black folks up in arms _____
_____ no body, you know.
I used to feel safe with the CIA but you making it look
_____ research you find out how many mistakes
they make, you know _____
he stood up _____ world wide press _____ he didn't
do it by himself and then the judge _____ down in Tennessee
so you _____ believe that, you know _____
is dead now and the only broad _____ in Tennessee that seen

the cat running out of the house say JAMES EARL RAY _____
now they wouldn't even let her come in and testify and when
you sit and look at JAMES EARL RAY who is from Illinois. You
aware of that he escaped from the penitentiary in Missouri,
Missouri State Penitentiary _____ after he
escaped from _____ the Missouri State Penitentiary _____
_____. For the
first time in the history of America the FBI said the wrong
thing _____ which _____ had
you caught it _____
_____ well he got busted _____. London
England he had a 130,000 in small bills on him _____
_____ guns you know
damn good and well that a cat with a _____
I had to take him to the hospital and operate on him like
they did _____ to take the bullet out because
the bullet will be _____ behind so we did some
research and we didn't have much time to do it as throughly
as we did on some of the other but we traced that he bought
the gun in Birmingham, Alabama, you _____ when he bought
the gun, three doors down from the CIA front shop that train
the pilots for the _____. Its just so blankly
open with their stuff and you know the warden you was the warden

of the Missouri State Penitentiary, you know who he was, he was the warden that was the head of the Atlanta Federal Penitentiary you remember when _____ was swapped for the Russian spy and that was the warden from the Atlanta Penitentiary State that made the swap that carried them over on the bridge and all at once we leave the Atlanta State Penitentiary and become warden of the Missouri State Penitentiary _____ JAMES EARL RAY escaped, there is some vicious things go _____

Briefly before I leave let me discuss with you the CIA in America and its no problem to do what you can do you know I can't understand that you have to leave the country you know I can't understand that as much _____ involved as we was with the Germans, that people in America just don't even know that HITLER's mother's mother _____ Grandmother was a Jew and it looked like this was common knowledge all over the world and just, get back to America and _____ simple things. Everybody seems to know about, you know, that HITLER lost the war because of Egypt _____ you youngsters _____ are young, but if you do any checking you will find out that he had plenty of B-1 rockets, B-2 rockets he had tanks, but he didn't have no war that's because the

Egyptians cut his arm off when he really found out he was going to come _____ racists bag _____ cleaver they found out he was talking about fighting somebody other than white folks, _____. Wait a minute boy, here is the history of the CIA in America. After World War II we didn't have a CIA, we had what we called the OSS, created by the late ALLAN DALLAS. We decided that we needed an intelligence unit as hip as the Germans, I don't know how the Germans could lose the war and we thought they had _____ something, so we went back and we made a deal with all the Nazi's that headed up the German Intelligence Unit that if they would come to America set us up internal security unit like they has, we will leave them free from prosecution, they came to America they set it up, its called the CIA, it was run in the beginning by them Nazi's and nobody know who it is it is run today by the Nazi's and nobody know who it is and anytime you bring some of them HITLER trained Nazi's into your Country and let them set up a secret organization and have total run of it, man we lucky we all aren't dead.

Yes brother?

How do I get all the information if its such top secret? Well hell information is the easiest thing in the world

_____ if you apply yourself, you know, _____
man set down and figured out how to bring nuclear things in
here and light up that field and I am sure finding out how the
CIA got involved with the Nazi's is the simplest thing to do
with the cats that figure they Army that ain't no big thing,
I mean all you do is just apply yourself and spend some time.
Let me give you a better example, in Chicago any of you from
Chicago? Are you familiar with SHERMAN _____
the Judiciary Department there. A friend of mine about five
years ago, _____ talking about how corrupt the courts
were so we _____ if he spend time and do your
homework, you know he just kept coming by crime, he used to
go down with his petition and they would lock him in the
elevator and take his crutches and beat him and tear up his
wheel chair. SHERMAN _____ home work and if you
go to Chicago now, SHERMAN _____ is probably the Number
one citizen in Chicago, here is what he did? He took his
wheel chair, kept doing his research and he went down and he
started looking up the stock bills and see all these bills got
to be registered and he found out out of the seven supreme
court justices State Supreme Court Justices of Illinois, six
of them owned banks, then when he looked up he found out that

AT&T has a minimum of 50 million dollars deposits and all six of them banks so you automatically know now when AT&T is getting ready to ask for a telephone increase in Illinois, you can't take it to court and win because they got the _____ of AT&T taken out of the 50 million dollars off their back. He also found out that the Burlington Railroad _____ and went up to the State Supreme court beal Illinois, the State of Illinois, out of paying 500 million dollars taxws over their property in 40 counties the supreme court ruled they didn't have to pay taxes on it after he checked it out, he found out that the Burlington Railroad didn't only deal with the supreme court justice, the head man of Illinois but a week before that case was to be heard this justice ended up getting the insurance company that insured all the Burlington Railroad workers so its right there if you take the time and this is what I said earlier tonight. I said if you would take the time to write down every college in America and check out the board of directors in America you would find out the daily cause of 90 per cent of the problems from _____ if you willing to spend a few minutes to do your homework and investigated _____ this system couldn't stand up under their own investigation at all.

Yes brother?

If I stated the CIA is taking over the country in the background why am I for gun control? Because I just think you know that irregardless of the CIA taking over the country that is really no big threat to me _____ once they take it over they going to lose it in about five years, but if they took over the country right now the white, poor white man and the poor black man would be better off because least he would be getting fed they ain't going to do nothing but close the colleges down and _____ and all them going to have to lose their _____ and they going to re-distribute the wealth around the country and then once we got to go underground baby and them slick cats from Wall Street _____ son got to go underground with us but all that brain power _____ CIA won't be able to hold it long because there are some dumb cats in the CIA I mean they got to take a dumb cat thats graduated from college and decide he want to be a spy in 1969 thats like wanting to fraduate and be the lone ranger's son or somebody else. (clapping). But you know ah I am for gun control because you know the guns you got now you ain't killing the CIA with them and I just believe you know that we need a constitution interpretation

of the guns, all men have a right to bear arms in America, but when that was inked there wasn't no such thing as automatic hand guns and I think if that constitution say you got a right to defend your proerty you got a right to have a gun in your house thats a shotgun and I think you can defend your house better with a shotgun than you can with an automatic. I think if we want to have country where men have a right to have guns which I say is a right then lets make it a shotgun so you can't stick it in your pocket and walk across town and kill some innocent person, see you no threat to me if you walk around town with a shot gun and if I come through a green light and you come through a red light and hit my car and I see that shotgun, I'm going to say I'm sorry Mr. White Brother, I'm sorry I came through that light there, I thought it was green, but I guess it was red and I'm sorry. You see you no threat to me but some kind of way you know we got to do something because any body that wants to get hold to a gun can get hold of one and so I think you know that we can tighten it up to the extent you see, are you aware that 97 percent of everybody that gets killed or shot in America do not get shot by strangers only three per cent of the people in America in the course of a year that get shot or killed are killed by strangers, 97 percent of everybody that gets killed

in a homicide it happened by someone he knew, or someone
or his family thats the disgrace _____ you know we
sit around and we play with them unloaded guns, we leave them
around the house, a kid pickes them up and its a different
ball game _____ cat sticking a pistol in his pocket going
across town sticking up grocery store then it is coming out with
that double barrel shotgunt. I think that you know I would love
to see a case go up to the United States Supreme Court and
get a ruling and see if that in interpreted as a shotgun in
the house because you can damn sure protect your home better
with a rifle or shot gun and then its really no threat to me.

Thank you. We going to run _____
say to you thank you again. God Bless you, nature have fun.
(clapping).

VIA TELETYPE
NOV 25 1969
ENCIPHERED

- Mr. Tolson _____
- Mr. DeLoach _____
- Mr. Walters _____
- Mr. Mohr _____
- Mr. Bishop _____
- Mr. Casper _____
- Mr. Callahan _____
- Mr. Conrad _____
- Mr. Felt _____
- Mr. Gale _____
- Mr. Rosen _____
- Mr. Sullivan _____
- Mr. Tavel _____
- Mr. Soyars _____
- Tele. Room _____
- Miss Holmes _____
- Miss Gandy _____

WA 08 433PM EOM

URGENT 11-25-69 EMS

TO DIRECTOR (100-440423) AND NEW YORK PLAIN

NEW YORK VIA WASHINGTON

FROM CHICAGO (157-347) (P) 1P

~~CONFIDENTIAL~~

b6
b7C

RICHARD CLAXTON GREGORY, AKA, RM. 00: CHICAGO.

SOURCE, RELIABLE, ADVISED THIS DATE THAT

IT WAS DETERMINED THAT GREGORY ACCOMPANIED BY HIS

WIFE,

b7D

SOURCE UNABLE TO DETERMINE PURPOSE OF TRIP OTHER THAN TO
FULFILL SPEAKING ENGAGEMENTS AND NO INFORMATION AVAILABLE
CONCERNING ITINERARY OR DURATION OF TRIP.

ADMINISTRATIVE

SOURCE IS

CHICAGO ATTEMPTING TO OBTAIN ITINERARY AND MAINTAINS CONTACT
WITH SOURCE. LHM FOLLOWS.

END

LRC R RELAY

FBI WASH DC

ENCLOSURE

1-28-80

1168 bks/EBM

REC-62

EX 110

18 DEC 1 1969

b7D

TELETYPED TO:

NY FTB
56 DEC 5 1969
MR. TOLSON
ROOM 836 92D

CIA, State, IDIU
Copy to Legats, London, Paris, Bern

by routing slip for
 info action
date 11/26/69
by CAE/m

~~CONFIDENTIAL~~

11-25-69

TO DIRECTOR (100-440423) AND NEW YORK
NEW YORK VIA WASHINGTON

FROM CHICAGO

RICHARD CLAXTON GREGORY, AKA, RM.

SOURCE RELIABLE, ADVISED THIS DATE

THAT GREGORY ACCOMPANIED BY HIS

WIFE,

b7D

SOURCE UNABLE TO DETERMINE PURPOSE OF TRIP OTHER THAN TO
FULFILL SPEAKING ENGAGEMENTS AND NO INFORMATION AVAILABLE
CONCERNING ITINERARY OR DURATION OF TRIP.

cc to 1010-10

100-440423-507

Sub Copy

ENCLOSURE

MAIL ROOM EDITION
GSA FPMR (41 CFR) 101-11.6

UNITED STATES GOVERNMENT

Memorandum

TO : DIRECTOR, FBI (100-440423)

DATE: 12/2/69

FROM : SAC, CHICAGO (157-347) (P)

~~CONFIDENTIAL~~

SUBJECT: RICHARD CLAXTON GREGORY, aka
RM
(OO: CHICAGO)

Re Chicago teletype to Bureau dated 11/25/69.

Enclosed herewith for the Bureau are 11 copies of a letterhead memorandum reflecting information concerning GREGORY's current travel. ~~(U)~~ (U)

b7D

Copies of this letterhead memorandum are being furnished to the United States Secret Service and Region I, 113th MI Group, Evanston, Illinois. ~~(U)~~ (U)

The source utilized in this letterhead memorandum is ~~(U)~~ (U)

Contact is being maintained with source and pertinent information concerning GREGORY's travels will be made immediately known to the Bureau. ~~(U)~~ (U)

1-15-80
CLASS. & EXT. BY 2842 PML/cab
REASON-FROM II, 1-2.4.8
DATE OF REVIEW 12-2-89

icc to STATE, IDIU, CLASS
By R/S 12/11/69
CAF/fmh

- 12/19/69
- (3) refer back to Legats, London, Bern, and Paris for info. (as will be returned)
- (2) - Bureau (RM) (Encl. 11)
- 3 - Chicago
- (1) -

~~(U)~~ (U)

REC-87 100-440423-508

DEC 4 1969

b7D

DFB:tlb
(5) // ENCLOSURE

~~CONFIDENTIAL~~

RACIAL MAT. SECT.





UNITED STATES DEPARTMENT OF JUSTICE

FEDERAL BUREAU OF INVESTIGATION

Chicago, Illinois
December 2, 1969

In Reply, Please Refer to
File No. 157-347

~~CONFIDENTIAL~~

RICHARD CLAXTON GREGORY

~~CONFIDENTIAL~~

A source who has furnished reliable information in the past advised on November 25, 1969, [redacted] it had been determined that Gregory, accompanied by his wife, [redacted]

[redacted] Source stated that the length of Gregory's trip was unknown, but evidently [redacted] b7D

Source advised that Gregory [redacted] ~~(U)~~

Source advised on December 1, 1969, that no further information has been received concerning Gregory's travel other than the fact that Gregory [redacted] ~~(U)~~

Copies of this letterhead memorandum are being furnished to the following agencies: The United States Secret Service and Region 1, 113th Military Intelligence Group, Evanston, Illinois.

1-15-80
CLASS. & EXT. BY 2842 pnc/cab
REASON-FCIM II, 1-2.4.2
DATE OF REVIEW 12-2-89

This document contains neither recommendations nor conclusions of the Federal Bureau of Investigation. It is the property of the Federal Bureau of Investigation and is loaned to your agency. It and its contents are not to be distributed outside your agency.

~~CONFIDENTIAL~~

2025 EDITION
GSA FPMR (41 CFR) 101-11.6

UNITED STATES GOVERNMENT

Memorandum

TO : DIRECTOR; FBI (100-440423)

FROM : SAC, BUFFALO (157-396) (RUC)

SUBJECT: RICHARD CLAXTON GREGORY, aka
RM

DATE: 12/10/69

Enclosed for Bureau are eleven copies and for Chicago two copies and for Boston one copy of LHM concerning a speech subject made before the student body of Elmira College, Elmira, N. Y. from 8:00 to 10:00 p.m., 12/2/69.

The source in LHM who requested identity be kept confidential was [redacted] Elmira, N. Y., an established source.

b6
b7C
b7D

LHM classified "Confidential" because unauthorized disclosure of information in it could reasonably result in the identification of [redacted] source of continuing value and compromise her effectiveness.

Since it is not known which statements of GREGORY might be of interest to any particular recipient of LHM, the newspaper account is set out in Xerox form in LHM.

Copies of LHM for Chicago, the office of origin, and for Boston, where subject last known to reside.

- 2 - Bureau (Encs. 11) (RM)
- 1 - Boston (Enc. 1) (Info) (RM)
- 2 - Chicago (157-347) (Encs. 2) (RM)
- 1 - Buffalo

EX-102

RWR:ck
(6)

ENCLOSURE

REC 18

100-440423-509

15 DEC 1969

b6
b7C

1 cc to ISD, ZDEU

By R/S 12/19/69

CAF/w

ALL INFORMATION CONTAINED
HEREIN IS UNCLASSIFIED
DATE 1-15-80 BY 2842

68 DEC 29 1969





UNITED STATES DEPARTMENT OF JUSTICE
FEDERAL BUREAU OF INVESTIGATION

In Reply, Please Refer to
File No.

Buffalo, New York
December 10, 1969

~~CONFIDENTIAL~~

RICHARD CLAXTON GREGORY

The November 25, 1969 edition of the "Star Gazette" newspaper, a daily publication in Elmira, New York, reported that "Dick Gregory, the controversial Civil Rights activist" would speak at Elmira College, Elmira, New York on December 2, 1969. His appearance would not be open to the public.

On November 26, 1969, a source who has furnished reliable information in the past, advised that GREGORY had been invited by the student body government for no particular reason other than that the student body felt they were tired of the "run of the mill" speaker and desired someone "controversial."

GREGORY's appearance before the Elmira College student body and a prior press conference were reported in the Elmira "Star Gazette," the only daily newspaper at Elmira, New York, in its edition of December 3, 1969, as follows:

DECLASSIFIED ON 1-15-80
BY 2848 / Cab

~~CONFIDENTIAL~~

100-440423-509
ENCLOSURE

Not Generation Gap; It's Moral Gap--Gregory

By KEN DARLING

Maybe Dick Gregory isn't reaching the majority of people in this country.

But, if his appearance at Elmira College Tuesday night was any indication, he's reaching the young people. And any hope this nation may have of surviving as a democracy, he believes, is firmly in their hands.

"You must solve the problems of this nation, problems you didn't create," he said. "It will be a tremendous job. But you have a great weapon on your side . . . moral, honest, ethical dedication."

The crowd of nearly 1,500, mostly Elmira College students, responded enthusiastically to Gregory as he encouraged their generation's activities, and used his humor and oratorical ability to chastise the Nixon administration, the military-industrial complex and other

symbols of the "establishment."

He received three standing ovations—one when he entered the Campus Center dining hall where the speech was held, one during his talk and one when he finished. And his speech was interrupted many times by applause and shouts of approval.

Gregory, a comedian, author, lecturer and actor, also was a Presidential candidate in the 1968 election on the Peace and Freedom party ticket with writer Norman Mailer.

Gregory said "There's no generation gap, there's a moral gap . . . you young folks have the all-important job of giving America its sanity back. Don't eulogize America—you eulogize dead things—but examine America."

Gregory told the students "Don't destroy capitalism.

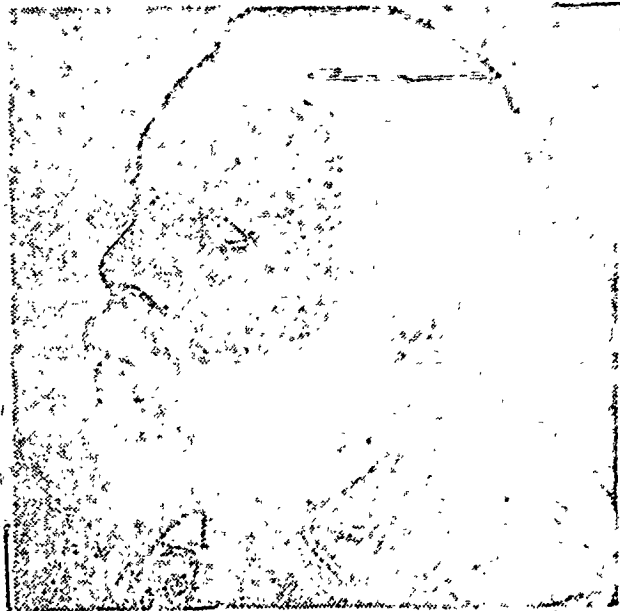

DICK GREGORY

Work to put the capitalist Constitution, not in front of it. where he should be, behind the "The emphasis should be on

human rights, not property rights."

Gregory devoted part of his talk to racial problems, saying "we blacks don't hate you white folks. But we do hate your sucking, white racist system."

He said, "I recognize an individual's right to be a racist—what I am opposed to is institutionalized racism."

Since he believes that business interests are a major reason for the continuance of the Vietnam war, Gregory had this suggestion for ending the war: "Boycott Christmas. Tell your friends and relatives that since there's a war going on you don't want to celebrate Christmas and you're not buying any presents."

He believes a total boycott of Christmas shopping would force the business world to pressure

Washington for a quick end to the war. "Maybe this year you wouldn't get any presents," he said. "But you'd be helping a lot of other people get presents next year . . . a mother would have her son home again from Vietnam . . . a kid would have his father back."

Gregory said that older people—"we old fools"—have always underestimated youth. "Nixon said the demonstrations would have no effect on him—but you kids forced him to go on television and talk about a Vietnam policy he doesn't even have."

He added, "If Nixon thinks young people aren't effective, he should place a call to LBJ in Texas and ask that boy. You dealt with LBJ—and if you can deal with him, you can deal with anybody. LBJ was slicker at 8 than Nixon will be if he lives to be 10,000."

U.S. Interest in Money Blamed for Not Ending War

"Everything has increased in value in this country but a dead soldier," Dick Gregory charged at a press conference before his speech at Elmira College Tuesday night.

Contending that this country's interest in money is a major obstacle in ending the war, the noted civil rights and anti-war leader suggested:

"If this nation said it would give \$50,000 to the family of every U. S. soldier killed in Vietnam, and if the kids of that soldier became wards of the government for life, suddenly you'd see a lot of influential people turn against the war."

Gregory was in Paris last weekend, talking with representatives of the National Liberation Front about the release of U.S. war prisoners for Christmas. He asked the NLF to pass along his request to the Hanoi delegation, which was not in Paris during the weekend.

He said "the NLF contends that the men being held by

North Vietnam are not war prisoners . . . war has not been declared on their country, so how can they have prisoners of war?"

He said that he has no idea if his efforts to free some prisoners for Christmas will be successful.

Gregory said that two years ago, the North Vietnamese and the Viet Cong were more concerned about black U.S. soldiers, because of what they'd heard about the suppression of blacks in America.

"Now, because of the anti-war activities of the young whites, the North Vietnamese believe that all soldiers — both blacks and whites — are merely puppets of the government."

Regarding the investigation of the My Lai massacre, Gregory said the NLF representatives think it's unfair that a few officers "are being used as scapegoats. They contend that since these massacres happen frequently, they must

be sanctioned by higher authorities than the officers in the field."

On President Nixon's Vietnam policy, Gregory commented "I feel he really had a program on Vietnam when he took office, but he's discovered how this country is really run."

Like the past presidents, he's become a slave to the military-industrial complex."

Gregory believes that minority groups were "better off under Johnson, but I'd rather have Nixon in office. Now more issues are coming out. There was no dialogue under LBJ . . . the blacks felt he was going to solve everything for them."

Gregory has mixed feelings about the American press. "Sometimes they make honest mistakes, sometimes they're just part of the establishment," he said. But he added that "the free press has done more to solve problems than to create them."

However, he noted that "when the press calls you a responsible black leader, that means you're no good for the black community."

Expressing his hope that the young people will work to solve the nation's problems, Gregory said "because of the activities of the white kids, the young

blacks are finding that black and white are not colors, but attitudes."

He also noted: "We blacks were campaigning for civil rights. Today, the young white kids are seeking human rights. We wanted the right to work in the napalm factory, along with the whites. The white kids want to close the napalm factory."

Gregory said a major role of young people is to alert the rest of the world about what's happening in this country. "If the young Germans had resisted Hitler, other countries would have been warned and could have prepared for him. If you do nothing more than get clubbed and tear-gassed in the streets, you'll alert the world that another monster is on the loose."

He added, "I hope you young people understand the job you have to do. Don't make the mistake we old fools made — when we were in college, we were too busy learning how to make a living and forgot to learn how to live."

Gregory's noted humor was evident throughout his speech. A couple of samples:

On riots: "When people ask me why there weren't more riots by black people last summer, I tell them all the black militants were in Ireland serving as technical advisers."

On Spiro Agnew: "He's got to be putting us on. If he's as dumb as he appears, he couldn't chew gum and walk at the same time."

~~CONFIDENTIAL~~

~~CONFIDENTIAL~~

RICHARD CLAXTON GREGORY

Investigator [redacted] Elmira, New York Police Department, was present at the speech given at Elmira College by GREGORY, and he noted that although the newspaper account of his speech indicated there were almost 1500 persons present, his estimate of the crowd was from 500 to 700 people.

b6
b7C

Investigator [redacted] advised that for the most part, he found the response to GREGORY's speech rather cold although he did receive an ovation on entering the building; another ovation when he made a remark that college administrators across the country were more interested in building funds than in educating students; and he received a few ovations whenever he made remarks about Vietnam. Investigator [redacted] advised that the above newspaper accounts are very good summaries of GREGORY's speech.

This document contains neither recommendations nor conclusions of the FBI. It is the property of the FBI and is loaned to your agency; it and its contents are not to be distributed outside your agency.

~~CONFIDENTIAL~~

UNITED STATES GOVERNMENT

Memorandum

0

TO : DIRECTOR, FBI

DATE: 12/15/69

FROM : SAC, DALLAS (157-946) (RUC)

JFL

H

SUBJECT: RICHARD CLAXTON GREGORY aka
RM

OO - CHICAGO

4

Enclosed herewith for the Bureau are eight copies, and for Chicago two copies of LHM, relating to captioned subject.

ALL INFORMATION CONTAINED
HEREIN IS UNCLASSIFIED
DATE 1-15-80 BY 8842 PMU/Kew

L

REC-78

100-440423-510

DEC 16 1969

- 2 - Bureau (encls - 8) (RM)
- 2 - Chicago (157-347) (encls-2) (RM)
- 1 - Dallas

JFL:jeg
(5)

ACST ~~OST~~ SEC. SERV.
LEPT: ~~10~~, IDIU, ~~10~~

HOW FORW: S/S
DATE FORW: 12/23/69
BY: CAF





UNITED STATES DEPARTMENT OF JUSTICE
FEDERAL BUREAU OF INVESTIGATION

In Reply, Please Refer to
File No.

Dallas, Texas
December 15, 1969

RICHARD CLAXTON GREGORY

"The December 9, 1969, issue of the "Fort Worth Star Telegram", a newspaper published daily in Fort Worth, Texas, carried the following article.

ALL INFORMATION CONTAINED
HEREIN IS UNCLASSIFIED
DATE 1-15-80 BY 2842 PND/cw

100-440923-510

This document contains neither recommendations nor conclusions of the FBI. It is the property of the FBI and is loaned to your agency; it and its contents are not to be distributed outside your agency.

Comedian Aims Bitter Humor

At America in Address at TCU

By LYNN GARLAND

America as seen through the eyes of Dick Gregory isn't beautiful.

In an emotion-charged speech laced with bitter humor, black comedian and social activist Gregory presented an indictment of America's social and economic ills to more than 1,000 students at TCU's Ed Landreth auditorium.

Criticizing President Nixon's speech on Vietnam, Gregory charged, "He aimed that speech at all Americans too old to go to Vietnam and get their brains blown out."

Patriots of the past, Gregory continued, were for the oppressed. Today, he contended, they support the oppressors.

He recommended that persons supporting the President's policies on Vietnam should enlist in the armed forces rather than show support by turning on car lights. (During Moratorium activities, some Nixon supporters expressed their views by turning on their headlights.)

"Turning on your car lights ain't going to do nothing but sell batteries," he said.

GREGORY PRAISED today's young people as the most "moral, ethical, com-

mitted group who have ever lived in this country."

He said today's youngsters would have to solve problems inherited from their parents.

"Times are changing and your mommy and daddy don't seem to see it," he said.

"You youngsters have the responsibility to give this country its sanity back," he added. "Thanks to you young people, this country is not dead yet."

Blacks in America do not hate whites, Gregory continued. But they do hate "white racist institutions."

"You are responsible to this white racist system, and we hold you responsible," he said.

WHILE MAINTAINING he did not advocate overthrow of the capitalistic system, Gregory told the students to work "to get the capitalists into their rightful place, which is behind the Constitution instead of in front of it."

He urged the young people to seek an end to the Vietnam conflict by boycotting Christmas. Boycotted merchants, he contended, would then put pressure on the government to bring the war to a close.

Gregory's talk ranged over a wide range of topics. On

black studies programs in American schools, he said:

"A man without knowledge of himself is like a tree with no roots."

On the Democratic convention in Chicago:

"For years white folks have been going to Fort Lauderdale and tearing up the whole town. Nobody called up the Army."

ON AMERICAN history:

"You landed at Plymouth, Rock and discovered a country that was already occupied."

On looters:

"With pride you tell me you got on this stranger's ship and dumped all that tea in the water."

RICHARD CLAXTON GREGORY

Detective Lieutenant [redacted] Fort Worth, Texas, Police Department, advised that the scheduled itinerary for "Dick Gregory" while in Fort Worth, on December 8, 1969, was as follows:

Gregory was to arrive at Love Field, Dallas, Texas, where he would be met by student representatives from Tarrant County Junior College (TCJC), Fort Worth, Texas, and then drive to the Howard Johnson Motor Lodge, 5825 South Freeway, Fort Worth. At 8:45 a.m., Gregory was to be picked up by the TCJC staff and be driven to the TCJC South Campus where he was to hold a press conference at 9:00 a.m., in the conference room in the administration building. Gregory was to speak to those present at the TCJC gymnasium at 10:00 a.m.

b6
b7c

At 11:00 a.m., representative from Texas Christian University (TCU), Fort Worth, were to drive Gregory to lunch at the Canterbury House, 2715 Cockrell, the home of TCU Episcopal minister. Gregory was to hold a press conference in the TCU Student Union Center at 1:25 p.m., and to speak to those assembled in TCU Ed Landreth Auditorium at 2:00 p.m., as guest of the Forum committee.

TCU representatives were to drive Gregory to Love Field, Dallas, Texas, where he was to depart Dallas by plane after 4:00 p.m., for a speaking engagement believed to be in New Orleans, Louisiana, on the night of December 8, 1969.

Lieutenant [redacted] has advised that as far as he knew the above itinerary was followed by Gregory while in Fort Worth. He advised that no violence or demonstrations occurred during Gregory's appearances.

FBI

Date: 12/30/69

Transmit the following in _____
(Type in plaintext or code)

Via AIRTEL

~~CONFIDENTIAL~~ (Priority)

TO: DIRECTOR, FBI (100-440423)
FROM: SAC, CHICAGO (157-347)
SUBJECT: RICHARD CLAXTON GREGORY, aka
RM

gc

Re Chicago teletypes dated 12/23 and 12/24/69.

b7D

Enclosed for the Bureau are eight copies of
an LHM concerning a Christmas eve sit-in by subject at
Chatham, England.

Source is *U*

EX-102

REC-93

100-440423-511

b6
b7C
b7D

2 - Bureau (Encl. 8) (RM)
2 - Chicago
(1 - A)
HHS:pc
(4)

1-15-80 2842
CLASS. & EXT. BY
REASON-FCIM II, 1-2.4.2
DATE OF REVIEW *12-3*

ENCLOSURE

9 JAN 1 1970

AGENCY: ACSI, ~~SEC. SERV.~~, SEC. SERV., *CDA STATE Dept.*
DEPT: ISD, ~~...~~, IDIU, ~~...~~

HOW FORW: *rls*
DATE FORW: *1/16/70*
BY: *CAF/jms*

RACIAL INT SECT.

5 Approved: *[Signature]*
Special Agent in Charge
JAN 13 1970

~~CONFIDENTIAL~~ M Per _____



UNITED STATES DEPARTMENT OF JUSTICE
FEDERAL BUREAU OF INVESTIGATION

In Reply, Please Refer to
File No.

157-347

Chicago, Illinois
December 30, 1969

~~CONFIDENTIAL~~

RICHARD CLAXTON GREGORY

~~CONFIDENTIAL~~

On [redacted] a source, who has furnished reliable information in the past, advised as follows:

On [redacted]

[redacted]

(U)

b7D

Gregory's final destination was London, England, where he planned to be involved in a twenty-four hour fast at a cathedral from which he expected extensive publicity. (U)

The December 26, 1969, issue of the "Chicago Tribune," a newspaper published daily in Chicago, Illinois, carried the following article:

Mr. Jones

"Beatle John Lennon, his wife, Yoko, and comedian Dick Gregory took part in a Christmas eye sit-in fast outside Rochester cathedral. The demonstration, held under a weeping willow tree in front of the church, protested world poverty."

X LENNON

*ENGLAND
CANADA*

1-15-80
CLASS. & EXT. BY 2842 P.M/Kal
REASON-FCIM II, 1-2.4.2
DATE OF REVIEW 12-30-89

This document contains neither recommendations nor conclusions of the Federal Bureau of Investigation. It is the property of the Federal Bureau of Investigation and is loaned to your agency; it and its contents are not to be distributed outside your agency.

~~CONFIDENTIAL~~

100-440423-511

~~CONFIDENTIAL~~

ENCLOSURE

VIA TELETYPE
DEC 28 1969
ENCIPHERED

- Mr. Tolson _____
- Mr. DeLoach
- Mr. Walters _____
- Mr. Mohr _____
- Mr. Bishop _____
- Mr. Casper _____
- Mr. Callahan _____
- Mr. Conrad _____
- Mr. Felt _____
- Mr. Gale _____
- Mr. Rosen _____
- Mr. Sullivan
- Mr. Tavel _____
- Mr. Soyars _____
- Tele. Room _____
- Miss Holmes _____
- Miss Gandy _____

NR 011 CG PLAIN

845 PM URGENT [redacted] RSH
TO DIRECTOR
FROM CHICAGO (157-347) (P)

b7D

~~CONFIDENTIAL~~

RICHARD CLAXTON GREGORY, AKA, RM, OO; CHICAGO.

SOURCE, RELIABLE, ADVISED INSTANT, RICHARD CLAXTON

GREGORY [redacted]

b6
b7C

[redacted]

[redacted]

CLASS. & EXT. BY 2842 PML/ab
REASON-FCIM II, 1-2.4.2
DATE OF REVIEW 12-23-87

GREGORY TO BE INVOLVED IN A TWENTYFOUR HOUR FAST

AT UNKNOWN CATHEDRAL LONDON AND EXPECTS EXTENSIVE PUBLICITY.

EXACT NATURE OR PURPOSE OF FAST OR PEOPLE TO BE INVOLVED

NOT KNOWN TO SOURCE. (U)

~~CONFIDENTIAL~~

REC-51

100-440423-512

ADMINISTRATIVE

SOURCE IS [redacted]

GREGORY 10 DEC 30 1969

b7D

[redacted]

LHM TO FOLLOW. [redacted]

REC'D COMM INTL DIV

DEC 10 1969

END CC-MR. SULLIVAN

LRC FBI WASH DC

12/28/69; [redacted] furnished London press reported Gregory's presence at Canterbury Cathedral with JOHN LENNON & LENNON'S wife. Nobody else showed up for fast & fast called off.

TELETYPED TO 53 JAN 3 1970

~~CONFIDENTIAL~~

173

~~CONFIDENTIAL~~

b7D

[Redacted]

TO DIRECTOR
FROM CHICAGO

RICHARD CLAXTON GREGORY, AKA, RN, OO; CHICAGO.

SOURCE, RELIABLE, ADVISED INSTANT, RICHARD CLAXTON

GREGORY

[Redacted]

b7D

[Redacted]

[Redacted]

~~(U)~~ (U)

GREGORY TO BE INVOLVED IN A TWENTYFOUR HOUR FAST
AT UNKNOWN CATHEDRAL LONDON AND EXPECTS EXTENSIVE PUBLICITY.
EXACT NATURE OR PURPOSE OF FAST OR PEOPLE TO BE INVOLVED
NOT KNOWN TO SOURCE.

~~(U)~~ (U) 1-15-80

CLASS: & EXT. BY 2842 PWB/kab
REASON-FCIM II, 1-2.4.2
DATE OF REVIEW 12-23-89

COPY SENT IDIU

~~CONFIDENTIAL~~

This document contains neither
recommendations nor conclusions of
the FBI. It is the property of the
FBI and is loaned to your agency;
it and its contents are not to be
distributed outside your agency.

~~CONFIDENTIAL~~

ENCLOSURE

100-440423-512

8

F.B.I.

Date: 12/30/69

Transmit the following in _____
(Type in plaintext or code)

Via AIRTEL AIR MAIL
(Priority)

Mr. Tolson	_____
Mr. DeLoach	_____
Mr. Walters	_____
Mr. Mohr	_____
Mr. Bishop	_____
Mr. Casper	_____
Mr. Callahan	_____
Mr. Conrad	_____
Mr. Felt	_____
Mr. Gale	_____
Mr. Rosen	_____
Mr. Sullivan	_____
Mr. Tavel	_____
Mr. Soyars	_____
Tele. Room	_____
Miss Holmes	_____
Miss Gandy	_____

TO: DIRECTOR, FBI (100-440423)
 FROM: SAC, SAN FRANCISCO (157-457) (RUC)
 SUBJECT: RICHARD CLAXTON GREGORY, aka
 RM
 CR 00: Chicago

b6
b7C
b7D

Enclosed for the Bureau are 8 copies of an LHM with two copies for Chicago. Source utilized is [redacted] San Jose, California, by request. The LHM is classified "confidential" because information furnished by [redacted] could reveal his identity and compromise his future effectiveness.

ALL INFORMATION CONTAINED
 HEREIN IS UNCLASSIFIED
 DATE 1-15-80 BY 2842 PMV/cal

ENCLOSURE

- 2 - Bureau (RM) (Enc. 18.)
- 2 - Chicago (157-347) (RM) (Enc. 2) REC-89
- 1 - San Francisco

JD:lmk AGENCY:ACSI, SEC. SERV., I.R.S.
 (5) DEPT: ISD, IDIU, (9/5/69)

HOW FORN: k/c
 DATE FORN: 1/2/70
 BY: CFE

100-440423-514
 JAN 9 1970
 Per [signature]

Approved: [signature]
 Special Agent in Charge

Sent _____

57 JAN 16 1970



In Reply, Please Refer to
File No.

~~CONFIDENTIAL~~
UNITED STATES DEPARTMENT OF JUSTICE
FEDERAL BUREAU OF INVESTIGATION

San Francisco, California

December 30, 1969

RICHARD CLAXTON GREGORY

Richard Claxton Gregory, more commonly known as Dick Gregory, appeared at speaking engagements at San Jose State College, San Jose, California, on November 25-26, 1969 and December 10-11, 1969, and at Chabot College, Hayward, California, December 9, 1969.

The "Spartan Daily", a newspaper published daily by the students at San Jose State College (SJSC) in its issue of November 7, 1969 published an article entitled "Ex C Offers a Chance to Teach, Learn, Exchange Ideas." An editor's note set forth that it was exploring the Associated Students Experimental College and its program. The article was by staff writer Craig Turner.

The article set forth in part that the Scholar-In-Residence Program is worked through the Experimental College. The funds are provided by the College Union Program Board which also selects the scholar. According to the article this year's Scholar-In-Residence is Dick Gregory, "militant former comedian."

A source on December 22, 1969, advised that Dick Gregory as Scholar-In-Residence at SJSC appeared on the campus on November 25-26, 1969 and again on December 10-11, 1969 and receives a stipend of either \$7,000 or \$7,500 for the year.

Source advised that "Scholar-In-Residence" is a misnomer in that Gregory is not a resident and has no intention of changing his present residence.

~~CONFIDENTIAL~~
Group 1

Excluded from automatic
downgrading and
declassification

DECLASSIFIED ON 1-15-80
BY 2842 PMO/kal.

This document contains neither recommendations nor conclusions of the FBI. It is the property of the FBI and is loaned to your agency; it and its contents are not to be distributed outside your agency.

100-440423-514

ENCLOSURE

RICHARD CLAXTON GREGORY

Source further advised that Gregory plans to return to SJSC in the spring of 1970 with possibly two additional appearances.

The "Spartan Daily" issue of November 14, 1969 announced "Black Experience Week Begins 10-Day Course." The article went on to state that the San Jose Black Studies Department would open its doors to students, faculty, and the public in recognition of "Black Experience Week." The article went on to state that Scholar-In-Residence Dick Gregory would be on the campus November 24-25, 1969 to conclude the event.

The "Spartan Daily" for November 25, 1969 published an article entitled "Dick Gregory - Niggers No More" by Terry Pennel, daily staff writer. The article disclosed that on the previous day Gregory had visited various classrooms and had held question and answer session between the reels and showing of "Battle of Algiers" based on the revolutionary struggles of Algiers for independence from the French. The article stated that Gregory described the black revolution in America today as a similar phenomenon.

The article stated that earlier in the day Gregory attended classes and told students "There is only one way blacks can react after reading white history. All we've ever heard about is what hoodlums we are...We've got to let America know that we are not 'niggers' any more."

The "Daily Review," a newspaper published in Hayward, California, in its issue of December 10, 1969 published an article on Dick Gregory's appearance at Chabot College Student Center in Hayward, California, on December 9, 1969. His talk was sponsored by the College's Office of Community Services and an admission of \$1 was charged.

The paper reported that Gregory in his talk to nearly 1,000 laced together a stirring set of charges against what he termed "racist and degenerate establishment."

~~C O N F I D E N T I A L~~

RICHARD CLAXTON GREGORY

Gregory told that America has always needed a nigger but he hasn't always been black and the time is coming when someone white will be the "nigger" or scapegoat. Part of his talk was devoted to the recent "police raid" on the Black Panther Party (BPP) headquarters in Chicago. He described the police tactics as "Hitler-like."

Gregory charged that colleges have been indoctrinating for so long that they have forgotten to educate. He claimed that the Vietnam Moratorium helped to tell the world that there is still morality and sanity in America. He was quoted as saying "You start feeding black people and you is just liable to feed 'em too much - enough to free them." This reference was to the BPP Breakfast Program.

The crowd attending the talk is described as twice being on their feet in response to what Gregory had to say.

A characterization of the BPP is contained in the appendix.

The "Spartan Daily" in December 9, 1969, announced that Gregory would visit the San Jose State Campus for the second time on December 10, 1969 and address the College Community in the College Union.

The "Spartan Daily" on December 11, 1969, reported that on the previous day Gregory is reported to have said that the students have become "new niggers in America."

Gregory made reference to the shooting in early December, 1969 of Black Panther Fred Hampton who was killed in Chicago, Illinois, during a police raid. Gregory said, "I don't believe in killing. I sent a \$1,500 check to Panthers Headquarters to buy food. I hope they don't go out and get guns and ammunition with it."

~~CONFIDENTIAL~~

RICHARD CLAXTON GREGORY

The "San Jose Mercury", a daily newspaper published in San Jose, California, in its issue of December 12, 1969 reported Gregory this date visited the campus at SJSC. According to the newspaper Gregory's theme was "You kids have got all the problems and none of the tricks." He also complained of the unequal treatment of the BPP as compared with the Minutemen and the Ku Klux Klan in contemplating recent events involving fight for rights of minority people. He attributed the difference to the fact that the Panthers are trying to change the system. He claimed it was not the guns that scare the power structure, it is "feeding the poor country folks that gets them angry."

~~CONFIDENTIAL~~

BLACK PANTHER PARTY, aka
Black Panther Party for
Self Defense

According to its official newspaper, the Black Panther Party (BPP) was started during December, 1966, in Oakland, California, to organize black people so they can take control of the life, politics, and the destiny of the black community. It was organized by Bobby George Seale, BPP Chairman, and Huey P. Newton, BPP Minister of Defense. Newton is presently serving a sentence of 2 to 15 years on a conviction of manslaughter in connection with the killing of an Oakland police officer.

The official newspaper, "The Black Panther," which further describes itself as the "Black Community News Service," states that the BPP advocates the use of guns and guerrilla tactics in its revolutionary program to end oppression of the black people. Residents of the black community are urged to arm themselves against the police who are consistently referred to in the publication as "pigs" who should be killed.

"The Black Panther" issue of September 7, 1968, contains an editorial by BPP Minister of Education, George Mason Murray, which ends with the following:

"Black men. Black people, colored persons of America, revolt everywhere! Arm yourselves. The only culture worth keeping is a revolutionary culture. Change. Freedom everywhere. Dynamite! Black Power. Use the gun. Kill the pigs everywhere."

Included in the introduction to an article appearing in the October 5, 1968, edition of "The Black Panther" is the statement, "...we will not dissent from American Government. We will overthrow it."

Issues of "The Black Panther" regularly contain quotations from the writings of Chairman MAO Tse-tung of the People's Republic of China and feature MAO's statement that "political power grows out of the barrel of a gun."

The national headquarters of the BPP is located at 3106 Shattuck Avenue, Berkeley, California. Branches have been established at various locations throughout the United States.

APPENDIX

UNITED STATES GOVERNMENT

Memorandum

TO : Director, FBI (100-440423)

DATE: 1/12/70

FROM : *CJF* Legat, London (157-99) (U) (RUC)

SUBJECT: RICHARD CLAXTON GREGORY
RM

~~CONFIDENTIAL~~

OO: Chicago (157-347)

Re newspaper clipping from London "Daily Express"
12/27/69 forwarded to Bureau 12/31/69. (U)

[Redacted Box]

information on a confidential basis, advised as follows:

Subject, possessing U.S. Passport K761916, arrived at London Airport 12/24/69 aboard TWA Flight 770 from Chicago. At the time subject cleared immigration controls, he advised his destination in London was the Playboy Club and that after staying in London a few days, he might travel on to Paris, France.

b6
b7C
b7D

CJM

1-15-80
CLASS. & EXT. BY 2842 JMU/Kal
REASON-FCIM II, 1-2.4.2 1-15
DATE OF REVIEW 1-12-2000

1-C G
R/S 1/22/70
cal/mw

EX-102

3 - Bureau
1 - Liaison (direct)
1 - London
JTM:vw
(5)

REC-14

100-440423

15 JAN 16 1970

~~CONFIDENTIAL~~

~~CONFIDENTIAL~~



56 JAN 23 1970

Buy U.S. Savings Bonds Regularly on the Payroll Savings Plan

FBI

Date: 1/23/70

Transmit the following in _____
(Type in plaintext or code)

Via AIRTEL AIRMAIL
(Priority)

TO : DIRECTOR, FBI (100-440423)
FROM : SAC, ALBANY (157-258) (P)
SUBJECT: RICHARD CLAXTON GREGORY, aka
Dick Gregory
(AGITATOR INDEX)
RM

Re Albany airtel to Bureau, 10/11/69.

Enclosed herewith for the Bureau are seven copies, and for Chicago two copies, of an LHM concerning subject's appearance at Adirondack Community College, Town of Queensbury, N.Y., on 1/9/70.

The confidential source utilized in the LHM is

[Redacted] whose information
[Redacted] in the past has proven to be reliable.

Coverage was afforded by appropriate local police agencies; namely the NYSP, South Glens Falls, N.Y., and the Warren County SO, Lake George, N.Y.

Locally the LHM is being disseminated to 108th MIG, Albany; OSI; Secret Service, Syracuse; and NIC.

- (2- Bureau (Encs. 7) (RM) *1-804 D*)
- 2- Chicago (157-347) (Encs. 2) (RM)
- 2- Albany

DVH:dap
(6)

AGENCY: ACST, NIC, OSI, SEC. SERV., *LJA*

DEPT: ISD, GRD, RAO *FDH*

HOW FORW: *F/S*

DATE FORW: *1/30/70*

BY: *[Signature]*

JAN 26 1970

54 FEB 9 1970

Approved: *[Signature]*

Special Agent in Charge

ALL INFORMATION CONTAINED
HEREIN IS UNCLASSIFIED
DATE *1-15-80* Sent BY *[Signature]*

b6
b7C
b7D

*4
2
1
7*

*1/28/70
0-7 to
Alb ch
to delete
1/28/70*

[Signature]

ENCLOSURE
LA-110
29100-440423-516

[Redacted]

AL 157-347

[redacted] also advised that in the very near future he expects to obtain the tape of GREGORY's speech. He volunteered to have it reproduced and will furnish it to the FBI.

b6
b7C
b7D

The Albany Office will forward the tape to the Bureau when made available by [redacted].

This LHM is classified "CONFIDENTIAL" inasmuch as unauthorized disclosure of its contents might identify the source of information thereby precluding his future use and jeopardizing the national defense.



~~CONFIDENTIAL~~
UNITED STATES DEPARTMENT OF JUSTICE
FEDERAL BUREAU OF INVESTIGATION

In Reply, Please Refer to
File No.

Albany, New York
January 23, 1970

RICHARD CLAXTON GREGORY,
also known as
Dick Gregory

On January 9, 1970, at 8:00 PM, GREGORY delivered a speech at the Adirondack Community College Gymnasium, Queensbury, New York, before approximately 1,300 people, namely college students and young adults.

Among the highlights of his presentation, which lasted for approximately two hours, before a question and answer session followed, were the following:

GREGORY had some observations on President Nixon's Vietnam speech before the Christmas holidays asserting that "he aimed at all the old folks in America, who are too old to go to Vietnam".

GREGORY admonished the "patriots in America" only concern themselves with Indian reservations. He warned of right-wing Government for too long a period saying that "when NIXON gets through with you, baby, he is going to make that silent majority the most vocal group in America".

He decried the slayings of the JOSEPH YABLONSKI family and remarked that in the trial of BOBBY SEALE in Chicago, Illinois, that the shackling and gagging of SEALE, if it had happened in Russia, would have caused people to shrug their shoulders and say "that is Communism for you".

He told of the danger in a conservative press. Declaring about the Chicago Democratic Convention, "they tried to tell you that you didn't see it on TV, they said the press created it."

100-440423-516

COPIES DESTROYED
9 NOV 19 1970

~~CONFIDENTIAL~~
DECLASSIFIED BY 2842 PMV/CLW 1-15-80
ENCLOSURE

~~CONFIDENTIAL~~

RE: RICHARD CLAXTON GREGORY

He was in part agreement with Vice President AGNEW, of the way he scared the press. He praised the moratorium demonstration on the Vietnam war in November, and observed that network coverage was given to it.

He did not advocate destroying the capitalist system but said that those present should work to put capitalist where they belong; behind the United States Constitution; not in front of it.

Focusing on civil rights and speaking as a black, GREGORY said "we do not hate white folk, we hate the stinking white racism system . . . who are responsible for this vicious white racism system, and we gonna hold you to it."

He said that "non-violence is my hang-up. I would find more joy tonight in being killed by a man than killing that man myself".

Handling floor questions after his monologue, GREGORY maintained that the Central Intelligence Agency killed MARTIN LUTHER KING, JOHN and ROBERT KENNEDY and MALCOLM X, assisted by the Federal Bureau of Investigation. In citing reasons for arriving at this conclusion, he adverted that KING could not have been shot as the Federal Bureau of Investigation said. He said that JAMES EARL RAY had \$400,000.00 on him when he arrived in England. The Federal Bureau of Investigation for the first time in history sent out the wrong fingerprints on RAY's escape.

When asked about ELDRIDGE CLEAVERS claim that the only way to reach law makers was for the Black Panthers to shot their way into the Senate, GREGORY replied "I do not agree with violence in anyway, shape or fashion". He also said "America to me is worth dying for, but I've never seen anything worth killing for".

~~CONFIDENTIAL~~

~~CONFIDENTIAL~~

RE: RICHARD CLAXTON GREGORY

GREGORY's appearance was sponsored by the Cultural Affairs Committee of the Student Senate of Adirondack Community College. He was introduced by WALTER MC MENAMIN, English instructor and Chairman of the Committee.

This document contains neither recommendations nor conclusion of the FBI. It is the property of the FBI and is loaned to your agency; it and its contents are not to be distributed outside your agency.

F B I

Date: 1/27/70

Transmit the following in _____
(Type in plaintext or code)

Via AIRTEL _____
(Priority)

To : Director, FBI (100-440423)
From : SAC, Minneapolis (157-386) (RUC) *TRC*
Subject: RICHARD CLAXTON GREGORY, aka
RM
OO: Chicago

Enclosed for the Bureau and Chicago are 8 and 2 copies, respectively, of an LHM concerning GREGORY's appearance in the Minneapolis Division.

Chicago's attention is directed to the fact GREGORY is supposedly leaving for Denmark.

The source noted in the LHM is [redacted] who gave the information to SA [redacted] is an established source of this office.

b6
b7C
b7D

- ② - Bureau (Enc. 8) (RM)
- 2 - Chicago (157-347) (Enc. 2) (RM)
- 3 - Minneapolis
(1 - 100-13319)
(1 - 157-619)

ERS:CK
(7)

ALL INFORMATION CONTAINED
HEREIN IS UNCLASSIFIED
DATE 1-15-80 BY 2842 DMK/cal

AGENCY: RAO ATT: [redacted] IDIU
ACSI, SEC SER.

DATE FORW: 2/2/70
HOW FORW: 10/5
BY: CAF/dkt

100-440423-517

JAN 29 1970

REC-III

b6
b7C

Approved: 57 FEB 3 1970 *RBH/w*
Special Agent in Charge

Sent _____ M _____



UNITED STATES DEPARTMENT OF JUSTICE

FEDERAL BUREAU OF INVESTIGATION

In Reply, Please Refer to
File No.

Minneapolis, Minnesota
January 27, 1970

Richard Claxton Gregory

The January 22, 1970, issue of the "Minnesota Daily," the student newspaper of the University of Minnesota, Minneapolis, indicated that Gregory spoke during the evening of January 21, 1970, at Augsburg College, Minneapolis.

Gregory told the audience of nearly 1,000 that the Number One problem in this country today is moral pollution and America is the most morally polluted country on the face of the earth. He said America's young people are the most marvelous, honest, dedicated people in the history of this country and urged the youthful crowd to examine America, find out where the cancer is, and then cut it out.

He reflected that the Democratic Convention in Chicago was the best thing that ever happened to the young folks because it pointed out how sick and degenerate this racist society is. Gregory told the audience that America's biggest problem is not capitalism, but capitalists. Gregory commented he didn't advocate destroying the capitalist system but restoring it to its rightful place, which is not ahead of, but rather behind, the United States Constitution.

Gregory urged the crowd to address their grievances to the capitalist system. He advised college students to learn to live and not make the mistake his generation did, which was being so busy, when going to college, trying to learn to make a living that they forgot how to live.

The article indicated Gregory was to leave for Denmark, where he would rejoining John Lennon in a two-to-three-week fast to call attention to the problems of the world's hungry people.

A source, who has furnished reliable information in the past, advised that Gregory's speech at Augsburg College was sponsored by the Black Student Union of Augsburg College. The source estimated Gregory received \$1,000, including expenses, for his speech.

100-440423-517

ALL INFORMATION CONTAINED
HEREIN IS UNCLASSIFIED
DATE 1-15-80 BY 8842 JAC/kal

ENCLOSURE

THIS DOCUMENT CONTAINS NEITHER
RECOMMENDATIONS NOR CONCLUSIONS OF
THE FBI. IT IS THE PROPERTY OF
THE FBI AND IS LOANED TO YOUR AGENCY;
IT AND ITS CONTENTS ARE NOT TO BE
DISTRIBUTED OUTSIDE YOUR AGENCY.

F B I

Date: 2/2/70

Transmit the following in _____
(Type in plaintext or code)

AIRTEL

AIR MAIL

Via _____
(Priority)

TO: DIRECTOR, FBI (100-440423)
FROM: SAC, NEW ORLEANS (157-6951) (P)
SUBJECT: RICHARD CLAXTON GREGORY, aka
RM-BN
(OO: Chicago)

TD

Re New Orleans airtel to Bureau 11/14/69.

Subject GREGORY spoke at Centenary College, Shreveport, La. night of 2/1/70 without incident. Summary being obtained and pertinent information will be furnished Bureau and Chicago.

CL

ALL INFORMATION CONTAINED
HEREIN IS UNCLASSIFIED
DATE 1-15-80 BY 2842 PMU /cal

REC-64

100-440423-518

EX-117

22 FEB 5 1970

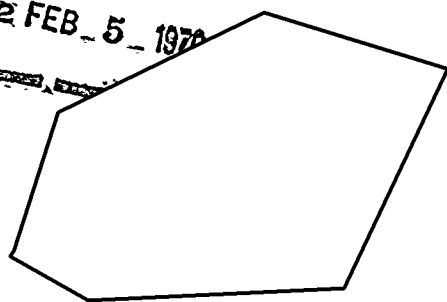

b6
b7c

- 2 - Bureau
- 2 - Chicago
- 2 - New Orleans

TPK/amm
(6)

ved;

M

Per

FBI

Date: 1/30/70

Transmit the following in _____
(Type in plaintext or code)

Via A I R T E L _____
(Priority)



b6
b7c

TO: DIRECTOR, FBI
FROM: SAC, MIAMI (157-NEW) (C)

LECTURE OF DICK GREGORY,
MIAMI-DADE JUNIOR COLLEGE,
NORTH CAMPUS,
MIAMI, FLORIDA,
1 - 3 P.M.,
1/29/70
EM
(OO: CHICAGO)

Enclosed for the Bureau are 11 copies of an LHM dated and captioned as above and suitable for dissemination.

Enclosed for Chicago are two copies of above mentioned LHM.

For the information of the Bureau, GREGORY's speech was recorded on tape and a copy of this tape is being maintained in the Miami file. GREGORY made no remarks which could be interpreted as attempts or threats to create a riot or disturbance.

*Index ISD
R/S 2/3/70
cab/ma*

*1-804 D
7- desk/ma*

- 2 - Bureau (Enc. 11) (RM)
 - 2 - Chicago (Enc. 2) (157-347) (RM)
 - 1 - Miami
- DNJ/lb:jgs
(3)

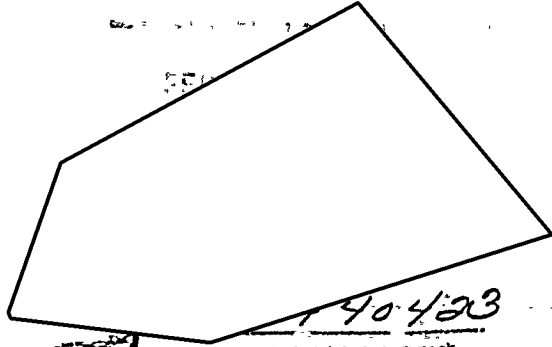

ENCLOSURE

ALL INFORMATION CONTAINED
HEREIN IS UNCLASSIFIED
DATE 1-15-80 BY 8842 PNU/ical

NOT RECORDED
125 FEB 5 1970

Approved: _____ Sent _____ M Per _____

5 FEB 13 1970 Special Agent in Charge

ORIGINAL FILED IN 157-6-29-1781
b6
b7c



UNITED STATES DEPARTMENT OF JUSTICE

FEDERAL BUREAU OF INVESTIGATION

In Reply, Please Refer to
File No.

Miami, Florida
January 30, 1970

Re: LECTURE OF DICK GREGORY,
MIAMI-DADE JUNIOR COLLEGE,
NORTH CAMPUS,
MIAMI, FLORIDA
1 - 3 P.M.,
JANUARY 29, 1970
RACIAL MATTERS

On January 29, 1970, Detective [redacted]
[redacted] Dade County Department of Public Safety,
Miami, Florida, advised that at a lecture Comedian DICK
GREGORY spoke at Miami-Dade Junior College, North Campus,
from 1 - 3 p.m. Several hundred students including
blacks, whites, and those of Spanish extraction, attended
GREGORY's lecture which took place without incident.
The speech was held at the John F. Kennedy Health Center
which is located on the campus.

b6
b7c

This speech was sponsored by the Miami-Dade
Junior College Student Government Association according to
an article which appeared in the "Miami Times", a weekly
Miami, Florida, newspaper, dated January 23, 1970.

Copies of this memorandum are being furnished
locally to the 111th M. I. Group, the U. S. Secret Service,
and the U. S. Attorney, Miami, Florida.

This document contains neither recommendations
nor conclusions of the FBI. It is the property of the FBI
and is loaned to your agency; it and its contents are not
to be distributed outside your agency.

ALL INFORMATION CONTAINED
HEREIN IS UNCLASSIFIED
DATE 1-15-80 BY 2848 JMW/1cl

1*

100-440423

ENCLOSURE

FEDERAL BUREAU OF INVESTIGATION
COMMUNICATIONS SECTION

JW
TELETYPE

FBI WASH DC

FBI DETROIT

2:16PM URGENT 1/30/70 NRA 2P

TO DIRECTOR AND CHICAGO
FROM DETROIT (157-)

Mr. Tolson	✓
Mr. DeLoach	✓
Mr. Walters	✓
Mr. Mohr	✓
Mr. Bishop	✓
Mr. Casper	✓
Mr. Callahan	✓
Mr. Conrad	✓
Mr. Felt	✓
Mr. Gale	✓
Mr. Rosen	✓
Mr. Sullivan	✓
Mr. Tavel	✓
Mr. Trotter	✓
Tele. Room	✓
Miss Holmes	✓
Miss Gandy	✓

b6
b7c

①
SPEAKING APPEARANCE OF RICHARD CLAXTON GREGORY , AKA.,
DICK GREGORY, WESTERN MICHIGAN UNIVERSITY, KALAMAZOO,
MICHIGAN, FEB. THREE NEXT, RM. ^{RACIAL MATTERS}

SOURCE, RELIABLE IN PAST, ADVISED THAT DICK GREGORY,
A WELL-KNOWN NEGRO COMEDIAN, WILL APPEAR AT EIGHT-PM. FEB.
THREE, NEXT, AT WESTERN MICHIGAN UNIVERSITY (WMU), KALAMAZOO,
MICHIGAN, AT THE EXPENSE OF WMU STUDENTS ASSOCIATION AND AT
EIGHT PM WILL GIVE A SPEECH OPEN TO THE PUBLIC FREE OF CHARGE
IN THE AUDITORIUM.

8360

SOURCE ADVISED THAT PRIOR TO THIS SPEECH GREGORY WILL
ARRIVE IN KALAMAZOO AT THREE FORTY PM VIA NORTH CENTRAL
AIRLINES, FLIGHT EIGHT SEVEN FIVE, AND AT FIVE THIRTY PM
WILL HOLD A MEETING WITH MEMBERS OF THE MARTIN LUTHER KING
SCHOLARSHIP FUND WHICH FUND IS SET UP UNDER FEDERAL GRANT
TO PROVIDE TUITION AND HOUSING FOR INDIGENT NEGRO STUDENTS.

100-440423-519

FEB 10 1970
REC 98

SIX

RACIAL SECT

5 FEB 19 1970
XEROX
END PAGE ONE

173

ALL INFORMATION CONTAINED
HEREIN IS UNCLASSIFIED
DATE 1-25-80 BY 2842 PML/cal

PAGE TWO

USA, GRAND RAPIDS, SECRET SERVICE, GRAND RAPIDS AND
G-TWO, DETROIT, ADVISED.

ADMINISTRATIVE:

SOURCE IS

[REDACTED]

[REDACTED]

b6
b7C
b7D

DETROIT WILL OBTAIN COVERAGE.

LHM FOLLOWS.

END.

CAH

FBI WASH DC

CC- MR. SULLIVAN

FEDERAL BUREAU OF INVESTIGATION
COMMUNICATIONS SECTION

FBI WASH DC

FEB 4 1970

TELETYPE

Mr. Tolson	_____
Mr. DeLoach	✓
Mr. Walters	_____
Mr. Mohr	_____
Mr. Bishop	_____
Mr. Casper	_____
Mr. Callahan	_____
Mr. Conrad	_____
Mr. Felt	_____
Mr. Gale	_____
Mr. Rosen	_____
Mr. Sullivan	✓
Mr. Tavel	_____
Mr. Soyars	_____
Tele. Room	_____
Miss Holmes	_____
Miss Gandy	_____

b6
b7C

FBI DETROIT

4:33 PM URGENT 2-4-70 NMG

TO DIRECTOR AND CHICAGO

FROM DETROIT (157-5447) 2P

~~CONFIDENTIAL~~

SPEAKING APPEARANCE OF RICHARD CLAXTON GREGORY, AKA
DICK GREGORY, WESTERN MICHIGAN UNIVERSITY, KALAMAZOO,
MICHIGAN, FEBRUARY THREE, NINETEEN SEVENTY, RM

SOURCE ONE, RELIABLE, ADVISED GREGORY APPEARED AS
SCHEDULED AT WESTERN MICHIGAN UNIVERSITY (WMU) AUDITORIUM
APPROXIMATELY EIGHT O'CLOCK P.M., FEBRUARY THREE, LAST,
WHERE HE SPOKE TO CAPACITY CROWD OF ABOUT FOUR THOUSAND
PERSONS. SPEECH GENERALLY NON-VIOLENT. NO INCIDENTS
OCCURRED. ~~(S)~~ (U)

SOURCE TWO, RELIABLE, INFORMED GREGORY DID NOT HOLD
DISCUSSION WITH MARTIN LUTHER KING STUDENTS AT WMU, NOR
DID HE ATTEND PRE-ARRANGED MEETING WITH LOCAL NEGRO COMMUNITY
LEADERS. ~~(S)~~ (U)

100-440423-520

REC 98

FEB 6 1970

SOURCE TWO ADVISED THAT GREGORY LODGED AT HOLIDAY INN

ENCLOSURE

MOTEL, KALAMAZOO, [REDACTED]

b7D

END PAGE ONE

~~CONFIDENTIAL~~

COPY SENT IDIU
(FILE COPY ATTACHED)

CLASS. & EXT. BY 2842 P.M.H./cal
REASON-FCIM II, 1-2.4.2
DATE OF REVIEW 2-4-90

51 FEB 19 1970

XEROX

JAN 1970

~~CONFIDENTIAL~~

157-5447

PAGE TWO

~~CONFIDENTIAL~~

b7D

[REDACTED]

[REDACTED]

~~(U)~~

GREGORY DEPARTED KALAMAZOO, SEVEN TWENTY A.M., FEBRUARY FOUR, INSTANT, FOR CHICAGO, ILLINOIS.

G-TWO, DETROIT, SECRET SERVICE AND USA, GRAND RAPIDS ADVISED.

ADMINISTRATIVE

RE DETROIT TEL TO BUREAU AND CHICAGO, JANUARY THIRTY, LAST.

b6
b7C
b7D

SOURCE ONE IS

[REDACTED]

~~(U)~~

SOURCE TWO IS

[REDACTED]

~~(U)~~

LHM FOLLOWS.

END.

SLB

FBI WASH DC

~~CONFIDENTIAL~~

~~CONFIDENTIAL~~

COPY SENT * IDIU

CC- MR. SULLIVAN

~~CONFIDENTIAL~~

PAGE TWO

[REDACTED]

b7D

[REDACTED]

~~(U)~~

GREGORY DEPARTED KALAMAZOO, SEVEN TWENTY A.M., FEBRUARY
FOUR, INSTANT, FOR CHICAGO, ILLINOIS.

G-TWO, DETROIT, SECRET SERVICE AND USA, GRAND RAPIDS
ADVISED.

~~CONFIDENTIAL~~
~~CONFIDENTIAL~~

FEDERAL BUREAU OF INVESTIGATION
COMMUNICATIONS SECTION

FEB 14 1970

TELETYPE

FBI WASH DC

FBI OMAHA

12:05 P.M. 2-14-70 URGENT MEP

Mr. Tolson	_____
Mr. DeLoach	_____
Mr. Walters	_____
Mr. Mohr	_____
Mr. Bishop	_____
Mr. Casper	_____
Mr. Callahan	_____
Mr. Conrad	_____
Mr. Felt	_____
Mr. Gale	_____
Mr. Rosen	_____
Mr. Sullivan	_____
Mr. Tavel	_____
Mr. Soyars	_____
Tele. Room	_____
Miss Holmes	_____
Miss Gandy	_____

TO: DIRECTOR (157-2780)

CHICAGO (157-347)

FROM: OMAHA (157-217)

DICK CLAXTON GREGORY. RM.

b6
b7C
b7D

IOWA CITY, IOWA (PROTECT IDENTITY) ADVISED GREGORY SCHEDULED TO SPEAK AT MAIN STUDENT LOUNGE, UNIVERSITY OF IOWA, EIGHT PM, FEBRUARY SIXTEEN NEXT. HIS TOPIC WILL BE "SOCIAL PROBLEMS- SOCIAL OR ANTI-SOCIAL?", IN PROGRAM SPONSORED BY UNIVERSITY VISITOR LECTURE SERIES. ^{LI} BELIEVED GREGORY WILL DEPART IOWA CITY, IOWA, SAME NIGHT FOR RETURN CHICAGO BY AIR.

OMAHA WILL FOLLOW AND REPORT RESULTS GREGORY'S APPEARANCE, HOWEVER, FOR LACK ADEQUATE SECURITY WILL NOT ATTEND GREGORY'S APPEARANCE, UTILIZING INSTANT SOURCE.

EX-119

ALL INFORMATION CONTAINED
HEREIN IS UNCLASSIFIED
DATE 1-15-80 BY 8842 QND/law

~~CORRECTION: LINE SIX, WD 4 SHD BE BELIEVED.~~

REC 14/00-440423-522

END.
57 FEB 20 1970

FEB 16 1970

FBI WASH DC

MR. TRAINOR
ROOM 836 9&D

F. B. I.

Date: 2/10/70

Transmit the following in _____
(Type in plaintext or code)

Via AIRTEL AIRMAIL - REGISTERED
(Priority)

TO: DIRECTOR, FBI (100-440423)

FROM: SAC, PORTLAND (157-329)

SUBJECT: RICHARD CLAXTON GREGORY, aka
Dick Gregory
RM
(OO: CG)

Enclosed for the Bureau and 11 copies and for Chicago two copies of a Letterhead Memorandum (LHM) regarding subject's appearance at Southern Oregon College, Ashland, Oregon, 2/23/70. Also enclosed for the Bureau are copies FD-376.

Copies of LHM are being disseminated to USA, Secret Service, Military Intelligence, OSI, and NIC all of Portland.

ALL INFORMATION CONTAINED
HEREIN IS UNCLASSIFIED
DATE 1-15-90 BY 2842 DMJ/cal

AGENCY: ACSI, ~~SEC. SERV.~~
DEPT: ISD ~~SEC. SERV.~~ FAZ U
HOW FORW: RLS
DATE FORW: 2/12/70
BY: caj/ame

4 destroyed
1-804)
11/20

REC-19

100-440423-523

- 2 - Bureau (Enc. 13) (AM) (RM)
- 2 - Chicago (157-347) (Enc. 2) (AM) (RM)
- 2 - Portland (1 - 157-329 DICK GREGORY)
(1 - 157-493 SOC-BSU)

JJM:lbt
(6)

//ENCLOSURE

3 FEB 1970

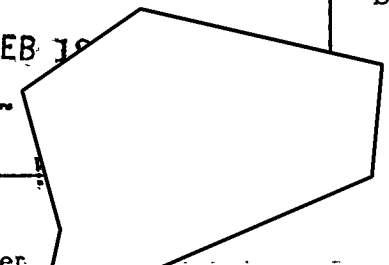

Approved: _____ Sent _____ M Per _____

55 FEB 25 1970

Special Agent in Charge

b6
b7c



UNITED STATES DEPARTMENT OF JUSTICE
FEDERAL BUREAU OF INVESTIGATION

WASHINGTON, D.C. 20535

In Reply, Please Refer to
File No.

Director
United States Secret Service
Department of the Treasury
Washington, D.C. 20220

February 10, 1970

Dear Sir:

The information furnished herewith concerns an individual who is believed to be covered by the agreement between the FBI and Secret Service concerning Presidential protection, and to fall within the category or categories checked.

1. Has attempted or threatened bodily harm to any government official or employee, including foreign government officials residing in or planning an imminent visit to the U. S., because of his official status.
2. Has attempted or threatened to redress a grievance against any public official by other than legal means.
3. Because of background is potentially dangerous; or has been identified as member or participant in communist movement; or has been under active investigation as member of other group or organization inimical to U. S.
4. U. S. citizens or residents who defect from the U. S. to countries in the Soviet or Chinese Communist blocs and return.
5. Subversives, ultrarightists, racists and fascists who meet one or more of the following criteria:
 - (a) Evidence of emotional instability (including unstable residence and employment record) or irrational or suicidal behavior;
 - (b) Expressions of strong or violent anti-U. S. sentiment;
 - (c) Prior acts (including arrests or convictions) or conduct or statements indicating a propensity for violence and antipathy toward good order and government.
6. Individuals involved in illegal bombing or illegal bomb-making.

Photograph has been furnished enclosed is not available
 may be available through Chicago Police Department

Very truly yours,

J. Edgar Hoover
John Edgar Hoover
Director

1 - Special Agent in Charge (Enclosure(s))
U. S. Secret Service, Portland, Oregon

Enclosure(s)

(Upon removal of classified enclosures, if any, this transmittal form becomes UNCLASSIFIED.)



UNITED STATES DEPARTMENT OF JUSTICE
FEDERAL BUREAU OF INVESTIGATION

In Reply, Please Refer to
File No.

Portland, Oregon

February 10, 1970

RICHARD CLAXTON GREGORY
Also Known As Dick Gregory
RACIAL MATTERS

The February 6, 1970 issue of "The Siskiyou," Southern Oregon College (SOC) student newspaper, Ashland, Oregon, on page 1, set forth that the Black Students Union (BSU), SOC, Ashland, is sponsoring a "symposium" on minority relations during February 22-24, 1970, at Ashland, Oregon. One of the speakers, Dick Gregory, identified as a noted civil rights worker and comedian, will appear on February 23, 1970, at the college gymnasium at 8 p.m., and his topic will be "Minorities in America." He is being sponsored by the SOC Concert and Lecture Series.

The BSU is described in the appendix attached hereto.

ALL INFORMATION CONTAINED
HEREIN IS UNCLASSIFIED

DATE 1-15-80 BY 2842 GMA/cal

- 1 -

This document contains neither recommendations nor conclusions of the FBI. It is the property of the FBI and is loaned to your agency; it and its contents are not to be distributed outside your agency.

100-440423-523
ENCLOSURE

THE BLACK STUDENTS UNION (BSU)

The Black Students Union is an organization of Negro College Students at various American universities for the purpose of advancing the educational level of the Negro student.

FBI

Date: 2/11/70

Transmit the following in _____
(Type in plaintext or code)

Via AIRTEL AIR MAIL
(Priority)

TO: DIRECTOR, FBI (100-440423)
FROM: SAC, NEW ORLEANS (157-6951) (RUC)
SUBJECT: RICHARD CLAXTON GREGORY, aka
RM-BN
(OO: Chicago)

Re New Orleans airtel to Bureau 2/2/70.

Enclosed are four copies of LHM of summary of
speech given by subject at Centenary College, Shreveport, La.
2/1/70. Source of information is [redacted] SAC Contact,
[redacted]

b7D

Two copies of LHM furnished Chicago.

ALL INFORMATION CONTAINED
HEREIN IS UNCLASSIFIED
DATE 1-15-80 BY 2842 PMU/cal

ISD, TDZU, SS
RIS 2/18/70
cab/mo

J

- ENCLOSURE
- 2 - Bureau (Enc 4) (RM)
 - 2 - Chicago (Enc 2) (RM)
 - 2 - New Orleans (1 - 157-6951)
 - (1 - SAC contact [redacted])

TPK/amm
(6)

REC-93 100-440423-524
FEB 13 1970

b6
b7C
b7D

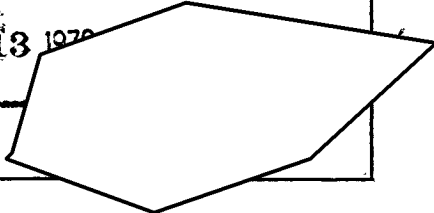

Approved: [Signature] Special Agent in Charge

Sent _____ M Per _____



UNITED STATES DEPARTMENT OF JUSTICE

FEDERAL BUREAU OF INVESTIGATION

New Orleans, Louisiana

February 11, 1970

In Reply, Please Refer to
File No.

RICHARD CLAXTON GREGORY

A reliable confidential source advised that on Sunday, February 1, 1970, Dick Gregory spoke at Brown Memorial Chapel, Centenary College. He arrived about 30 minutes late and the program began at 8:30 PM. Some young student who is on the Forum Committee introduced him and he started off his talk with a number of jokes and then talked for two hours. He then declared a five minute rest period so "people could leave without being called racists." Several people did leave at this time. After the break there was a fairly good discussion with several students challenging remarks made by him.

During the talk Gregory made only two remarks of a possible threatening nature. One was that 10 years ago Henry Ford did not give a damn about him and does not today except that Ford pays attention to him because he knows that if he, Gregory, gets displeased that "Gregory will burn his plant down." The other statement was something to the effect that if he was in Vietnam and got killed and was buried by the Viet Cong that he would be buried in the same trench with a white person. But, if he got killed and his body shipped back to the United States he could not be buried alongside a white man and "this makes me wonder whether I am shooting at the right people."

He criticized President Nixon severely saying that L.B.J. was smarter when he was eight years old than Nixon would be if he lived ten thousand years. He said that Nixon was dumb and he wishes that we had 50 Nixons because more progress in desegregation had been made under Nixon than any other President.

ALL INFORMATION CONTAINED
HEREIN IS UNCLASSIFIED
DATE 1-15-80 BY 8848 PAV/cal

ENCLOSURE

100-440423-524

RICHARD CLAXTON GREGORY

He was quite humorous in his presentation and in talking about Vice-President Agnew he said "Agnew was the kind of guy who would make a crank call on the hot line to Moscow."

He said that some objection is made to the Negro because of his "criminal tendencies" but he said that in Washington where they claim the crime rate is high because of Negroes that more stealing goes on on Capitol Hill than by the Negroes in Washington, D.C. He said that they claim the Negroes need education but that if education were the test the "Jews would own America."

His favorite line that he put in every five minutes was "no more tricks." He said that America was the worst nation on the face of the globe. He also said that white people seemed to be frightened of the Negro because of his possible involvement with white women but the Negro had been "programmed from youth" by seeing the ads by which the white woman was portrayed along with the new model cars, Pepsi-Cola, etcetera, and this made the Negro think the white woman was the ultimate attainment. He was rather coarse in several parts of his talk. He said he spent 90 per cent of his time on college campuses and that young people are having to straighten out problems that they did not create.

At the close of his talk he suggested that everybody buy his album which he said contained most of his talk.

Much of the talk was mere ramblings of a disjointed nature along with his jokes. He offered nothing of a constructive nature.

RICHARD CLAXTON GREGORY

Those in attendance were students, faculty, and school officials. Arrangements for the talk was by the Forums Committee of the Student Senate of Centenary College. There were approximately 500 in attendance.

Members of the press were not present during the talk, however, he was interviewed by the press prior to the talk.

This document contains neither recommendations nor conclusions of the FBI. It is the property of the FBI and is loaned to your agency; it and its contents are not to be distributed outside your agency.

2/12/70

AIRTEL

TO: DIRECTOR, FBI (105-165706-32)
FROM: SAC, NEW HAVEN (100-19186) (P)
SUBJECT: BLACK PANTHER PARTY
RM

NH 605-R* (NH T-12) who reports on the activity of the BPP, New Haven Chapter, 35 Sylvan Ave., New Haven, Conn., advised on 2/10/70, that [redacted]

[redacted] was in contact with [redacted] Willimantic, Conn. [redacted] discussed [redacted]

b6
b7C
b7D

[redacted] to speak. [redacted] according to this informant, has recently been in contact with BPP, New Haven, asking for a BPP speaker on April 11, 1970, at a black conference being sponsored by the Afro-American Society of Eastern Conn. State College.)

[redacted] to please come up with some funds because of their need. He pointed out that the BPP had people in jail and are in desperate need of money. [redacted] said that the Afro-American Society is sponsoring the meeting and that DICK GREGORY will be there on April 12, 1970. [redacted] told [redacted] that the most they could pay the Panthers in April would be \$25. [redacted] said he would reconsider and call [redacted] later.

- 4 - Bureau (2 - 105-165706-32)
 - (2 - 100-440423 D. GREGORY)
 - 4 - Chicago (2 - 157-1291)
 - (2 - 157-347 D. GREGORY)
 - 1 - San Francisco (Info)
 - 2 - New Haven
- GFB/jbm
(11)

100-440423-
NOT RECORDED
20 FEB 10 1970

REGISTERED MAIL

58 FEB 27 1970

ALL INFORMATION CONTAINED
HEREIN IS UNCLASSIFIED
DATE 1-15-88 BY 2648 PMA/cal

105-165706-32-470
ORIGINAL FILED IN

NH 100-19186

NH 605-R* (NH T-12) is being operated under Departmental authorization. Information obtained from this informant is classified "CONFIDENTIAL." Should it be necessary to disseminate this information outside the Bureau, it should be appropriately paraphrased in order to protect this highly sensitive source.

LEADS:

CHICAGO

Will attempt to verify above scheduled visit of DICK GREGORY at Eastern Conn. State College on April 12, 1970, and advise New Haven of type of coverage desired.

FBI

Date: 2/10/70

Transmit the following in _____
(Type in plaintext or code)

Via AIRTEL _____
(Priority)

TO: DIRECTOR, FBI
FROM: SAC, DETROIT (157-5447) (C)
SUBJECT: SPEAKING APPEARANCE OF
RICHARD CLAXTON GREGORY, aka.,
Dick Gregory,
WESTERN MICHIGAN UNIVERSITY,
KALAMAZOO, MICHIGAN
2/3/70
RM

3012

b6
b7C

Re Detroit teletype 2/4/70.

Enclosed for the Bureau are 11 copies and for Chicago two copies of an LHM regarding speaking appearance of captioned subject.

Two copies of the LHM are being furnished G-2, Detroit and Secret Service, Grand Rapids, and one copy of the LHM is being furnished USA, Grand Rapids, Michigan.

The sources utilized in the LHM are identified as follows:

Source #1 is [redacted]

[redacted]

Source #2 is [redacted]

100-448423-

NOT RECORDED
201 FEB 18 1970

The LHM is classified confidential to protect sources utilized, who are of a continuing value.

ENCLOSURE

- ② - Bureau (Enc. 11) (RM) AGENCY: ACST, OSI, SEC. SERV.,
 - 2 - Chicago (Enc. 2) (RM) DEPT: ISD,
 - 3 - Detroit (1 - [redacted]) (1 - [redacted])
- HOW FORW: R/S
DATE FORW: 2/16/70
BY: [redacted]

JHB/cmt

Approved: [redacted]

Special Agent in Charge

Sent _____ M

ENCLOSURE

53 FEB 26 1970

100-448423-180
2-118928-15-180
ORIGINAL FILED IN

b6
b7C

DE 157-5447

For the information of Chicago, in addition
to data set forth in LHM [redacted] advised that RICHARD
CLAXTON GREGORY has [redacted]
[redacted] and his home telephone number is

b6
b7C
b7D



UNITED STATES DEPARTMENT OF JUSTICE
FEDERAL BUREAU OF INVESTIGATION

In Reply, Please Refer to
File No.

Detroit, Michigan
February 10, 1970

~~CONFIDENTIAL~~

Re: Speaking Appearance of
Richard Claxton Gregory,
Also Known As,
Dick Gregory,
Western Michigan University,
Kalamazoo, Michigan
February 3, 1970

Source number one, who has furnished reliable information in the past, advised that Dick Gregory, a well-known Negro comedian, was engaged by the Student Association (SA) at Western Michigan University, Kalamazoo, Michigan, to give a speech at the Western Michigan University Auditorium on February 3, 1970. According to the source, the speech was scheduled to be open to the public and free of charge.

Source number one further advised that Gregory is scheduled to arrive in Kalamazoo at 3:40 p.m., February 3, 1970, via North Central Airlines Flight Number 875, from Chicago, Illinois, and arrangements were made for him to lodge at the Holiday Inn, Crosstown Parkway in Kalamazoo, Michigan.

Arrangements were made by the Western Michigan University SA for Gregory to meet with students under the Martin Luther King Scholarship Program at Western Michigan University prior to his speech. Students in this program are indigent Negroes whose tuition is funded with Federal grants.

~~CONFIDENTIAL~~

~~GROUP I~~

Excluded From Automatic
Downgrading and
Declassification

100-440423-

ENCLOSURE

~~ENCLOSURE~~

~~CONFIDENTIAL~~

Re: Speaking Appearance of
Richard Claxton Gregory,
Also Known As,
Dick Gregory,
Western Michigan University,
Kalamazoo, Michigan
February 3, 1970

Arrangements were also tentatively made by the Western Michigan University SA for Gregory to meet with local Kalamazoo Negro leaders after his speech.

Source number two, who has furnished reliable information in the past, advised on February 4, 1970, that Gregory appeared as scheduled at the Western Michigan University Auditorium at approximately 8:00 p.m., February 3, 1970, where he spoke before a capacity crowd of approximately 4,000 persons. The source characterized Gregory's speech as generally non-violent and noted that included among his topics were President Nixon, Vice President Agnew, the Negro problem, the poor white problem, and the Black Panther Party, (BPP).

A characterization of the BPP is contained in the appendix attached hereto.

The same source informed that in his remarks, Gregory referred to President Nixon as one of the "most stupid people in government" and defined Vice President Agnew as being "more stupid than the President". According to the source, no incidents occurred at Gregory's speech.

Source number one advised on February 4, 1970, that Gregory did not meet with the Martin Luther King students at Western Michigan University, nor did he attend the tentatively arranged meeting with the Kalamazoo Negro community leaders. Instead, Gregory spent much of his time in Kalamazoo at the University Field House where he engaged in athletic endeavors.

- 2 -
~~CONFIDENTIAL~~

~~CONFIDENTIAL~~

Re: Speaking Appearance of
Richard Claxton Gregory,
Also Known As,
Dick Gregory,
Western Michigan University,
Kalamazoo, Michigan
February 3, 1970

Source number one noted that Gregory, while lodged
at the [redacted] was in

[redacted]

b7D

Source number one further advised that Gregory
departed Kalamazoo at 7:20 a.m., February 4, 1970, via North
Central Airlines Flight 804, en route to Chicago, Illinois.

This document contains neither recommendations
nor conclusions of the FBI. It is the property of the FBI
and is loaned to your agency; it and its contents are not to
be distributed outside your agency.

- 3 -

~~CONFIDENTIAL~~

APPENDIX

1

BLACK PANTHER PARTY (BPP)

According to its official newspaper, the Black Panther Party (BPP) was started during December, 1966, in Oakland, California, to organize black people so they can take control of the life, politics, and the destiny of the black community. It was organized by BOBBY GEORGE SEALE, BPP Chairman, and HUEY P. NEWTON, BPP Minister of Defense. NEWTON is presently serving a sentence of 2 to 15 years on a conviction of manslaughter in connection with the killing of an Oakland Police Officer.

The official newspaper, "The Black Panther", which further describes itself as the "Black Community News Service", states that the BPP advocates the use of guns and guerrilla tactics in its revolutionary program to end oppression of the black people. Residents of the black community are urged to arm themselves against the police who are consistently referred to in the publication as "pigs" who should be killed.

"The Black Panther" issue of September 7, 1968, contains an editorial by BPP Minister of Education GEORGE MASON MURRAY, which ends with the following:

"Black men. Black people, colored persons of America, revolt everywhere! Arm yourselves. The only culture worth keeping is a revolutionary culture. Change. Freedom everywhere. Dynamite! Black Power, Use the gun. Kill the pigs everywhere."

Included in the introduction to an article appearing in the October 5, 1968, edition of "The Black Panther" is the statement, "...we will not dissent from American Government. We will overthrow it."

Issues of "The Black Panther" regularly contain quotations from the writings of Chairman MAO Tse-Tung of the People's Republic of China and feature MAO's statement that "political power grows out of the barrel of a gun."

~~CONFIDENTIAL~~

2

The national headquarters of the BPP is located at 3106 Shattuck Avenue, Berkeley, California. Branches have been established at various locations throughout the United States.

- 5* -

~~CONFIDENTIAL~~

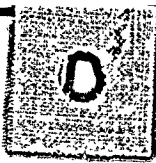

FBI

Date: 2/13/70

Transmit the following in _____
(Type in plaintext or code)

Via AIRTEL _____
(Priority)

TO: DIRECTOR, FBI
FROM: SAC, TAMPA (157-3163) (P)
DICK GREGORY
RM

b6
b7C
b7D

4 -
FW

SAC contact - campus source [redacted]
[redacted] advised GREGORY
scheduled for speaking appearance on 4/6/70, at Village
Center, FTU.

Chicago, through established sources, endeavor
to confirm foregoing.

- 2 - Bureau (RM)
- 2 - Chicago (RM)
- 4 - Tampa
 - (2 - 157-3163)
 - (1 - 80-474)
 - (1 - 100-1423)

TCA:rab
(8)

m

ALL INFORMATION CONTAINED
HEREIN IS UNCLASSIFIED
DATE 7-15-80 BY 2812 PML/cw

REC-51

1007-440423-525

b6
b7C

FEB 16 1970

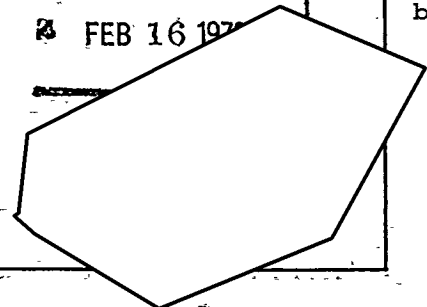

51 MAR 3 1970
Approved: _____
Special Agent in Charge

Sent _____ M Per _____

UNITED STATES GOVERNMENT

Memorandum

TO : DIRECTOR, FBI (100-440423)

DATE: 2/19/70

FROM : SAC, ALBANY (157-253) (RUC)

SUBJECT: RICHARD CLAXTON GREGORY, aka
Dick Gregory
(AGITATOR INDEX)
RM

Re Albany airtel to Bureau dated, 1/23/70.

Enclosed herewith for the Bureau is a copy of a tape of GREGORY's speech at Adirondack Community College, Queensbury, New York on 1/16/70 as voluntarily furnished to SA [redacted] by [redacted] at the College, who is a reliable and established source.

- ② - Bureau (RM) (Enc. 1)
 - 1 - Chicago (157-347)
 - 1 - Albany
- DVH:lew
(4)

return 8040
ENCLOSURE

ALL INFORMATION CONTAINED
HEREIN IS UNCLASSIFIED
DATE 1-15-80 BY 8842 JMD/al

100-440423-526

REC-126

FEB 20 1970

RACIAL INT. SECT.



MAR 3 1970

Buy U.S. Savings Bonds Regularly on the Payroll Savings Plan

FBI

Date: 2/25/70

Transmit the following in _____
(Type in plaintext or code)

AIRTEL

Via _____
(Priority)

TO: DIRECTOR, FBI
FROM: SAC, CHARLOTTE (157-NEW)

APPEARANCE OF RICHARD CLAXTON GREGORY,
NORTH CAROLINA STATE UNIVERSITY AT
RALEIGH, NORTH CAROLINA
MARCH 2, 1970
RM

sdh

R/S

Enclosed for the Bureau are 8 copies of LHM in captioned matter. Copies being disseminated locally to Secret Service and military intelligence agencies.

Information from [redacted] furnished to SA [redacted] who contacted [redacted] and Cpt. [redacted]

b6
b7C

Charlotte will follow GREGORY's appearance; and if tape recording is available, transcription will be made and copy furnished the Bureau.

2-destroed
1-8040 ENCLOSURE

100-114

- 2-Bureau (Encs. 8) (RM)
- 3-Charlotte (2 - 157-NEW)
- (1 - 157-177 Sub B)

100-440423-528

RRG:mjb
(5)

FEB 26 1970

b6
b7C

ACS I, [redacted]
SS, ESD, EDU
R/S 2/27/70
rot/mw

ALL INFORMATION CONTAINED

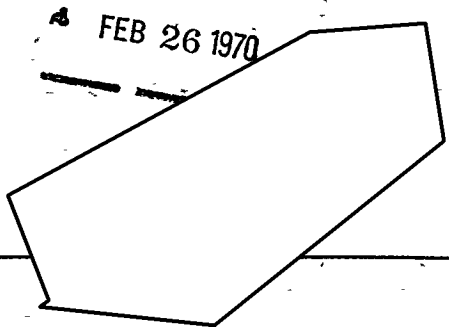

1-10-90
2842 pmu kfm

321
Approved: _____
Special Agent in Charge

Sent _____ M Per _____



UNITED STATES DEPARTMENT OF JUSTICE
FEDERAL BUREAU OF INVESTIGATION

In Reply, Please Refer to
File No.

Charlotte, North Carolina
February 25, 1970

APPEARANCE OF RICHARD CLAXTON GREGORY
NORTH CAROLINA STATE UNIVERSITY
RALEIGH, NORTH CAROLINA
MARCH 2, 1970
RACIAL MATTER

On February 20, 1970, [redacted]
[redacted] North Carolina State University (NCSU),
Raleigh, North Carolina, advised that RICHARD CLAXTON GREGORY,
also known as DICK GREGORY, is scheduled to participate in
"The Black Symposium Series" at North Carolina State University,
Raleigh, North Carolina, on March 2, 1970.

GREGORY is scheduled to participate in a 4:00 P. M.
seminar entitled, "Making It in Entertainment" and will speak
at 8:00 P. M. at the Erdahl-Cloyd Union on the subject, "The
Black Revolution and Afro-American Culture."

b6
b7c

RICHARD CLAXTON GREGORY, also known as DICK GREGORY,
is a nationally known night club entertainer and Civil Rights
activist who publicly endorses civil disobedience and militant-
type activities by Negroes under auspices of the Civil Rights
Movement.

On February 24, 1970, [redacted]
[redacted] North Carolina State Bureau of Investigation, and
Captain [redacted] Raleigh, North
Carolina, Police Department, were made aware of the above
investigation.

100-440423-528

THIS DOCUMENT CONTAINS NEITHER
RECOMMENDATIONS NOR CONCLUSIONS
OF THE FBI. IT IS THE PROPERTY
OF THE FBI AND IS LOANED TO YOUR
AGENCY; IT AND ITS CONTENTS ARE
NOT TO BE DISTRIBUTED OUTSIDE
YOUR AGENCY.

ENCLOSURE

ALL INFORMATION CONTAINED
HEREIN IS UNCLASSIFIED
DATE 1-10-80 BY 2842 pmv/rlm

FBI

Date: 2/20/70

Transmit the following in _____
(Type in plaintext or code)

Via Airtel _____
(Priority)

TO: DIRECTOR, FBI (157-2780)
FROM: SAC, OMAHA (157-217) (C)
SUBJECT: DICK CLAXTON GREGORY
RM

OO: Chicago

Re Omaha teletype to Bureau and Chicago entitled as above, dated 2/14/70.

Enclosed herewith for the Bureau are twelve (12) copies and for Chicago four (4) copies of an LHM captioned as above, which sets forth the results of a speech made by subject at the Main Student Lounge, University of Iowa, evening of 2/16/70.

b6
b7C
b7D

The source utilized in enclosed LHM is Lt. _____

_____ of Iowa, Iowa City, Iowa, who requests his identity be concealed.

Copies of this LHM are being disseminated to the USA, SDI, Des Moines, Iowa, MIG, Cedar Rapids, Iowa, U.S. Secret Service, Omaha, Nebraska, in view of these agencies continuing interest in these matters.

AGENCY: ACSI, ~~NSA~~, OSI, SEC. SERV.,

DEPT: ISD, ~~OSI~~ *FBI*

HOW FORW: *AIS*

DATE FORW: *2/25/70*

BY: *CAF/ML*

- ④ - Bureau (2) - 157-2780 (Enc. 10) (Registered Mail)
- (2 - 176-63) (Enc. 2)
- 4 - Chicago (2 - 157-347) (Enc. 2) (Registered Mail)
- (2 - 176-31) (Enc. 2)
- 2 - Omaha (1 - 157-217)
- (1 - 100-7058 - New Left Movement)

GDM: cac
(10)

REC-51

100-440423-527
FEB 22 1970

RECORDED COPY AND COPY OF ENCL FILED IN 176-63

b6
b7C

Approved: _____

Special Agent in Charge

ALL INFORMATION CONTAINED
HEREIN IS UNCLASSIFIED
DATE *1-15-80* BY *2842*
DMW/cav

OM 157-217

Enclosed LHM is classified confidential because it contains information received from the above mentioned source and the unauthorized disclosure of this information could tend to identify this source of value and compromise his continued effectiveness.



~~CONFIDENTIAL~~

UNITED STATES DEPARTMENT OF JUSTICE
FEDERAL BUREAU OF INVESTIGATION

In Reply, Please Refer to
File No.

Omaha, Nebraska

February 20, 1970

DICK CLAXTON GREGORY

On February 17, 1970; a source advised that Gregory spoke the night of February 16, 1970, to a standing-room only crowd of more than 2,000 persons in the Main Union Lounge, University of Iowa, Iowa City, Iowa. His topic was "Social Problems - Social or Anti-Social?", in a program sponsored by University Lecture Series.

Source said Gregory's speech touched off a week-long program at the University known as "Black Experience Week," with all events free and open to the public, although tickets for Gregory's talk were fifty cents.

In the course of his speech, Gregory said he sympathized with what he called the tasks the nation's youth have before them, and joked about what he called the ineptness of the current administration - and reminded his audience that he thought blacks hold whites responsible for society's ills.

Gregory said he felt sorry for today's youth. He likened their parents investments in them to a check that would bounce in 30 or 40 years. He pointed to the problems of southern school integration and whites protest against it, saying, "Who are the Southerners hurting by keeping their kids out of school?" He said he felt sorry for the kids and not their parents. From this remark, Gregory moved into an attack on President Nixon remarking, "Dick Nixon shows up the state of this nation better than anything." He said he would rather have Nixon in the White House than Hubert Humphrey, Lyndon Johnson, or any of the Kennedys. "Black folks have no trouble with a dumb white man - and Nixon is without doubt the dumbest."

~~CONFIDENTIAL~~

Group 1

Excluded from automatic
downgrading and
declassification

DECLASSIFIED ON 1-15-80
BY 2842 PWD/col

100-440423-527

DICK CLAXTON GREGORY

Source advised that David Eisenhower, Nixon's son-in-law, likewise was the butt of some of Gregory's humor, referring to Eisenhower as "Not as simple as I thought, up there joining them Naval Reserves."

Source advised further that Gregory discussed the strength American youth would have if they tried to end the war by an economic boycott, remarking, "If nothin' else works, next Thanksgiving threaten to boycott Christmas - you'll be surprised what happens, and if they ask what to tell your kids about Santa, tell them he's over in Vietnam droppin' napalm on babies." He went on to say that Patriots used to be on the side of the oppressed and that now they are on the side of the oppressor. He called American flag stickers sported on car windows as "a mark of bigotry, racism and stupidity." With this remark he was greeted with cries of "Right on!" from the audience, which source said is a cry used by Black Panther members.

Gregory warned about what he said would be the situation at the end of Nixon's administration. He said the silent majority is going to be the most vocal group ever heard, remarking, "You voted that trick into office, now you live with it."

Gregory emphasized the importance of the "Chicago Seven" trial as an example of what he said was the state of America. He said Black Panther Bobby Seale was indicted on conspiracy charges with seven other persons, five of whom Gregory said Seale didn't know. He said the real issue of that trial was the right of a defendant to defend himself. He remarked that in Los Angeles they let "that Manson boy" (accused of murdering Sharon Tate and others) defend himself, but because Seale was black he had to take a lawyer assigned to him.

In closing his talk, Gregory remarked that the blacks do not hate whites, they hate the white system and hold all whites responsible for it. He remarked that, "What the black wants is what Aretha Franklin asks for in her song. Just a little respect and dignity."

~~CONFIDENTIAL~~

DICK CLAXTON GREGORY

Source noted further that in connection with the week-long program referred to as "Black Experience Week" at University of Iowa, a program of poetry, dancing, clothing fashions, music and discussion has been scheduled, which will include four plays performed by students from Central State University in Wilberforce, Ohio.

The theme "Black Racism - White Racism" will be discussed over an open microphone on one of the days known as "Soundoff Soapbox". Poetry readings will be given by Val Gray and Sonja Sanchez, two nationally known black poets.

On one of the nights during the week, Bill Cosby's television film called, "Black History: Lost, Strayed or Stolen", will be followed by discussion among the viewers. A session of "Black Expression" is scheduled. Gospel singers, a guitarist playing blues and soul music, and poetry readings by University students, are on the program. The University's Black Dance Troupe will perform, which includes a selection of modern and African dances and an intermission ceremony dedicating the event to the memory of Malcolm X. Seventeen black students will be the dancers. There is to be a black fashion show made up of fourteen black students and paintings and sculpture by black University students will be shown.

Source said the above week-long program other than Gregory's speech, is sponsored by the Black Culture Area of the University Union Board.

Source advised there was no disorder of any sort in connection with Gregory's appearance. He arrived in Cedar Rapids, Iowa, by air from Chicago, Illinois, and returned to Chicago by air.

This document contains neither recommendations nor conclusions of the FBI. It is the property of the FBI and is loaned to your agency; it and its contents are not to be distributed outside your agency.

~~CONFIDENTIAL~~

FD 323

UNITED STATES DEPARTMENT OF JUSTICE

FEDERAL BUREAU OF INVESTIGATION

Omaha, Nebraska

February 20, 1970

Title: DICK CLAXTON GREGORY

Reference: Memorandum dated February
20, 1970, at Omaha, Nebraska

All sources (except any listed below) whose identities are concealed in referenced communication have furnished reliable information in the past.

This document contains neither recommendations nor conclusions of the FBI. It is the property of the FBI and is loaned to your agency; it and its contents are not to be distributed outside your agency.

FBI

Date: 3-5-70

Transmit the following in _____
(Type in plaintext or code)

Via AIRTEL _____
(Priority)

b6
b7C

TO: DIRECTOR, FBI (100-440423)
FROM: SAC, KNOXVILLE (157-1523) (P)

WILLIAM M. KUNSTLER
SM - MISC.

RICHARD CLAXTON GREGORY
RM

On 3-4-70, _____

_____ University of Tennessee (UT),
Knoxville, Tennessee, advised that KUNSTLER is to appear and
speak at the University of Tennessee, April 2, 1970, and that
DICK GREGORY is scheduled to appear and speak April 9, 1970,
in connection with "Man and his Environment" series.

In the 3-4-70 issue of the Knoxville News-Sentinel,
a daily publication, Knoxville, Tennessee, information set
forth that KUNSTLER to speak 4-2-70, at UT and that this speech
coincided with the date of the arraignment of UT students charged
in connection with the demonstration at UT on January 15, 1970.
Article indicated KUNSTLER had been previously contacted by
one of those arrested and he had agreed to serve in an advisory
capacity. His topic will be "The Conspiracy Trial: Its Legal
and Political Ramifications."

b6
b7C

Article further indicated that KUNSTLER assisted
University of Tennessee students last spring in a Federal Court
suit that eventually gave University of Tennessee an open
speaker policy.

EX-110 REC-58 REC-58 100-440423-5296

In addition, article indicated that on 4-9-70, DICK
GREGORY will also speak and it was the rejection of GREGORY
as a campus speaker some 16 months ago that helped spark
the open speaker policy controversy at UT.

- 4 - Bureau (RM)
- 4 - Chicago (2 - 157-347, RICHARD GREGORY) (RM)
(2 - WILLIAM KUNSTLER)
- 2 - New York (WILLIAM KUNSTLER) (RM)
- 6 - Knoxville (2 - 157-1523) (2 - 100-3811) (1 - 100-3979)

18 MAR 9 1970

AM:gsh (15)

Approved: _____

ALL INFORMATION CONTAINED

HEREIN IS UNCLASSIFIED
DATE 1-15-80 BY 88112

F 314

DMJ/cw

UNRECORDED COPY FILED

KX 157-1523

Contact being maintained with SSD.

Knoxville PD, Secret Service, and 111th MI GP are aware of the above.

Attempts are being made to have speech taped through SAC contacts and local newspapers and/or other sources.

Bureau will be kept advised.

FBI

Date: 3/4/70

Transmit the following in _____
(Type in plaintext or code)

Via AIRTEL _____
(Priority)

TO : DIRECTOR, FBI
FROM : SAC, NEW HAVEN (157-NEW) (RUC)
SUBJECT: BLACK ARTS FESTIVAL
BROWN UNIVERSITY
PROVIDENCE, RHODE ISLAND
MARCH, 1970
RACIAL MATTER

Enclosed for the Bureau are fifteen (15) copies of an LHM dated and captioned as above.

Enclosed for Boston are six copies of the same LHM. For Newark, New York and Chicago are four copies each of the same LHM.

The enclosed LHM is classified CONFIDENTIAL in order to protect a highly sensitive source of continuing value.

The source made reference to in the enclosed LHM is NH 605-R*, who reports on activities of the BPP, New Haven Chapter, 35 Sylvan Ave., New Haven, Conn.

- 6 - Bureau (2-Black Arts Festival)
 - (1-100-443566-J. FORMAN) (1-105-165706-32-BPP)
 - (1-100-440423-D. GREGORY)
 - (1-100-425307-LEROI JONES) (Encs. 15)
- 6 - Boston (2-157-Black Arts Festival)
 - (1-BPP) (1-157-) 1-157-654) (BPP)
 - (1-157-) (Encs. 6) 100-440423
- 4 - Chicago (2-157-Black Arts Festival)
 - (2-157-347-D. GREGORY) (Encs. 4)
- 4 - Newark (2-157-Black Arts Festival)
 - (2-100-42539-LEROI JONES) (Encs. 4)
- 4 - New York (2-157-Black Arts Festival)
 - (2-100-155090-JAMES FORMAN) (Encs. 4)
- 4 - New Haven (1-157-NEW)
 - (1-100-19186) (1-157-1462-)
 - (1-157-741-)

ORIGINAL FILED IN 157-16778-1

b6
b7c

SECURITY

6279

5 MAR 1970
GEB/368 - 81976

Approved: _____
Special Agent in Charge

ALL INFORMATION CONTAINED
HEREIN IS UNCLASSIFIED
DATE 1-15-80 BY 2826-DMJ/jaw
CARBON COPY

In addition, to that related in the enclosed LHM concerning the Black Arts Festival, [redacted] told [redacted] that he was related to GEORGE EDWARDS of the Panthers.

For the information of Boston, GEORGE EDWARDS is currently incarcerated in the State of Conn. on charges of murder for the slaying of ALEX RACKLEY, alleged BPP police informer whose body was found in Middlefield, Conn. in May, 1969.

b6
b7c

In addition to the information which appears in the enclosed LHM, this informant further reported on March 2, 1970, that on March 2, 1970, that [redacted] was in contact with [redacted] who gave his identity as [redacted] [redacted] referred to the fact that he was going to Brown University and [redacted] told him that there were students who would "put us up" [redacted] said that he and [redacted] (PH) would be also there (undoubtedly referring to the Black Arts Festival made reference to in the enclosed LHM).

THIS INFORMANT IS BEING OPERATED UNDER DEPARTMENTAL AUTHORIZATION. INFORMATION OBTAINED FROM THIS INFORMANT IS CLASSIFIED CONFIDENTIAL. SHOULD IT BE NECESSARY TO DISSEMINATE THIS INFORMATION OUTSIDE THE BUREAU, IT SHOULD BE APPROPRIATELY PARAPHRASED IN ORDER TO ADEQUATELY PROTECT THIS HIGHLY SENSITIVE SOURCE.

Any additional information obtained by New Haven through NH 695-R# concerning the Black Arts Festival will be furnished to Boston by appropriate communication.

LEADS: ..

NEWARK

Will attempt to determine whether or not LE ROI JONES will actually speak at the Black Arts Festival, Brown University, Providence, R.I. and if so advise Boston.

NEW YORK

Will attempt to determine whether or not JAMES FORMAN will be present at the Black Arts Festival, Brown University and advise Boston.

CHICAGO

Will determine whether or not DICK GREGORY will be present at the Black Arts Festival, Brown University, and advise Boston.



UNITED STATES DEPARTMENT OF JUSTICE
FEDERAL BUREAU OF INVESTIGATION

New Haven, Connecticut

March 4, 1970

~~CONFIDENTIAL~~

In Reply, Please Refer to
File No.

BLACK ARTS FESTIVAL
BROWN UNIVERSITY
PROVIDENCE, RHODE ISLAND
MARCH, 1970

On March 2, 1970, a source who has furnished reliable information in the past advised an individual whom the informant understood to be [redacted] that he, [redacted] at Brown University. [redacted] reportedly said that the festival, which is to be held in late March, 1970, will include such figures as LE ROI JONES, JAMES FORMAN, DICK GREGORY and others. This source advised that others mentioned by [redacted] who would be included in the festival were DON LEE, ISAAC HAYS, CANONBALL ADDERLY, SONJA SANCHEZ and CARL THOMAS.

b6
b7C

According to this source, [redacted] said that there would be a soul food banquet and a fashion show and that the cost of admission to the festival would be \$20.00 per couple.

This same source above has advised that CAPPY PINDERHUGHES is CHARLES PINDERHUGHES, the Lieutenant of Information for the Black Panther Party, New Haven Chapter.

This source further pointed out that [redacted] was disappointed that the Black Panther Party (BPP) had not been invited to participate in the festival, but that he was told by [redacted] that this was due to the fact that the college had placed certain restrictions upon the holding of the festival.

b6
b7C

DECLASSIFIED ON 7-29-77
BY 6855 Dml/Eaw

~~CONFIDENTIAL~~
GROUP 1 Excluded from automatic downgrading and declassification.

PROPERTY OF THE FBI
This document contains...
recommendations...
the FBI. It is the property of the
FBI and is loaned to your agency; it
and its contents are not to be
distributed outside your agency.

ENCLOSURE

100-440423 -

BLACK ARTS FESTIVAL
BROWN UNIVERSITY
PROVIDENCE, RHODE ISLAND
MARCH, 1970

~~CONFIDENTIAL~~

The source stated that [redacted] expressed the desire to [redacted] that the Panthers would like to set up an information center at the festival and that an information table for the entire weekend at the festival would be fine. According to this source, it was agreed upon between them that the program would be set up for the Panthers for Sunday, March 22, 1970, which would allow the Panthers to show films and display literature and posters.

b6
b7c

This source further advised that he was able to determine from [redacted] that [redacted] resided at [redacted] Providence, Rhode Island.

A characterization of the BPP appears in the Appendix Section.

2
~~CONFIDENTIAL~~

APPENDIX

BLACK PANTHER PARTY, aka
Black Panther Party for Self-Defense - Connecticut



On January 29, 1969, the "Bridgeport Telegram", a daily newspaper published at Bridgeport, Connecticut, contained in part the following:

"On January 28 (1969) the Black Panther Party was formed in Bridgeport, JOSE RENE GONZALVEZ announced last night at a meeting at party headquarters, 510 East Main Street. Mr. GONZALVEZ, a Cuban-born Oakland-trained black defense captain, spoke to twenty Negro youths in his mission here to organize a chapter of the political party..."

On March 18, 1969, the following Black Panther literature, published locally was distributed in the Bridgeport, Connecticut, area. It read in part as follows:

"The BPP is a party that will produce for the people and its members will do anything and everything possible to meet the demands of the poor oppressed black people. We are not a hoodlum gang, nor did we come here to kill white people or the police. We came here to stop racist actions that the oppressors (black and white) have been taking upon our people. We are the vanguard party and we intend to provide leadership for the people and revolutionary groups across the country..."

A source advised as of April 14, 1969, the New Haven Chapter of the Black Panther Party was operating under the authority of the National Organization. [redacted] had been given the authority to open this chapter in New Haven and to organize throughout the State of Connecticut.

[redacted] departed Connecticut in early May, 1969, and attempted to organize the Black Panther Party in Greensboro, North Carolina, for which he was suspended. State leadership in Connecticut was taken over by [redacted] a member and [redacted]

and [redacted]

b6
b7C

2

~~SECRET~~

BLACK PANTHER PARTY, aka
Black Panther Party for Self-Defense - Connecticut

On May 19, 1969, BOBBY GEORGE SEALE, National Black Panther Party chairman, spoke at Battell Chapel, Elm and College Streets, Yale University, New Haven, Connecticut. SEALE spoke in part as follows:

"...The struggle we are involved in is not a racial struggle, but a class struggle. We have to define the revolution that's occurring in this country as a people struggle... We've got to teach these kids to use guns so that when the racist pig comes down into our community and brutalizes our people, we are gonna kill... If we catch a pig brutalizing our people in the black community, we are gonna kill him - we are gonna stop him."

On 4/20/69, a second source advised that the Communist Party of Connecticut, held a State Convention at the Peoples Center, 37 Howe Street, New Haven, Connecticut, on that date. During this convention, it was announced that there was going to be a memorial service in New Haven on that date for three Black Panthers who were slain a year ago; and all members of the Communist Party were invited to attend this memorial.

The Black Panther Party presently has chapters in Bridgeport, New Haven, Hartford, and Middletown, Connecticut. Their leadership is presently confused since eight members of the Black Panther Party were arrested by the New Haven Police Department for the murder of ALEX RACKLEY, alleged Black Panther Party member from New York City, whose body was found in Middlefield, Connecticut, on May 21, 1969.

THE NATIONAL ORGANIZATION OF THE BLACK PANTHER PARTY
IS CHARACTERIZED SEPARATELY.

4

~~SECRET~~

APPENDIX

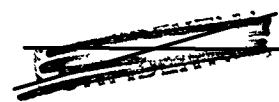

BLACK PANTHER PARTY, aka
Black Panther Party for Self-Defense

According to its official newspaper, the Black Panther Party (BPP) was started during December, 1966, in Oakland, California, to organize black people so they can take control of the life, politics and the destiny of the black community. It was organized by BOBBY GEORGE SEALE, BPP Chairman, and HUEY P. NEWTON, BPP Minister of Defense. NEWTON is presently serving a sentence of two to fifteen years on a conviction of manslaughter in connection with the killing of an Oakland police officer.

The official newspaper, "The Black Panther," which further describes itself as the "Black Community News Service," stated that the BPP advocates the use of guns and guerrilla tactics in its revolutionary program to end oppression of the black people. Residents of the black community are urged to arm themselves against the police who are consistently referred to in the publication as "pigs" who should be killed.

"The Black Panther" issue of September 7, 1968, contains an editorial by BPP Minister of Education, GEORGE MASON MURRAY which ends with the following:

"Black Men. Black people, colored persons of America, revolt everywhere! Arm yourselves. The only culture worthkeeping is revolutionary culture. Change. Freedom everywhere. Dynamite! Black Power. Use the gun. Kill the pigs everywhere!"

Included in the introduction to an article appearing in the October 5, 1968, edition of "The Black Panther" is the statement, "...We will not dissent from American Government. We will overthrow it."

Issues of the "Black Panther" regularly contain quotations from the writings of Chairman MAO Tse-tung of the People's Republic of China and feature MAO's statement that "political power grows out of the barrel of a gun."

The national headquarters of the BPP is located at 3106 Shattuck Avenue, Berkeley, California. Branches have been established at various locations throughout the United States.



FBI
~~CONFIDENTIAL~~ Date 9/18/70

Transmit the following in _____
(Type in plaintext or code)

Via AIRTEL AIRMAIL - REGISTERED
(Priority)

TO: DIRECTOR, FBI (100-440423)
FROM: SAC, PORTLAND (157-329) (RUC)
SUBJECT: RICHARD CLAXTON GREGORY, aka
Dick Gregory
RM
(OO: Chicago)

CLASS. & EXT. BY 2842 PML/cal
REASON-FCIM II, 1-2.4.2
DATE OF REVIEW 3-13-90

Re Portland airtel to Director, 2/10/70.

Enclosed for the Bureau are 11 copies and for Chicago 2 copies of a Letterhead Memorandum (LHM) regarding subject's speech at Southern Oregon College, Ashland, Oregon, 2/23/70. Two copies FD-376 enclosed for Bureau.

Source utilized in LHM is [redacted] Oregon, who voluntarily furnished information, and he requested his identity to be concealed. (U)

On 2/24/70, [redacted] Oregon (conceal identity), advised DICK GREGORY'S ticket cost \$1,753, and he arrived in Medford, Oregon, out of Boston, Massachusetts on 2/23/70. He left Medford, Oregon on 2/24/70, for Portland, Oregon, to Seattle, Washington, and on 2/25/70, he would take Flight 42 from Seattle, Washington to Baltimore, Maryland.

Copies of LHM are being disseminated to USA, Secret Service, Military Intelligence, OSI and NIC, all of Portland.

- 2 - Bureau (Enc. 13) (AM) (RM)
- 2 - Chicago (157-347) (Enc. 2) (AM) (RM)
- 2 - Portland (1 - 157-329) (DICK GREGORY)
(1 - 157-493) (SOC-BSU)

JJM:lbt

AGENCY: ACISI, OSI, SEC. SERV.
DEPT: ISD, [redacted], [redacted]
HOW FORW: [redacted]
DATE FORW: 3/70/70
BY: [redacted]

ENCLOSURE 2 - [redacted] REC-73

100-440423-530

MAR 18 1970

5 Approved: 1970
F315
Special Agent in Charge

~~CONFIDENTIAL~~

b6
b7C
b7D

b6
b7C

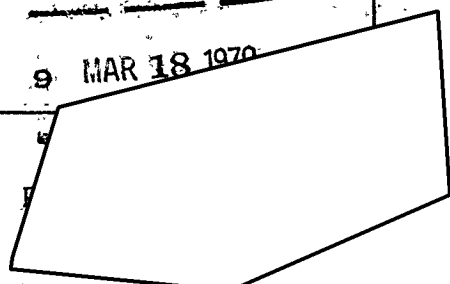



UNITED STATES DEPARTMENT OF JUSTICE

FEDERAL BUREAU OF INVESTIGATION

In Reply, Please Refer to
File No.

Portland, Oregon

March 13, 1970

RICHARD CLAXTON GREGORY

Also Known As

Dick Gregory

RACIAL MATTERS

Source utilized in this memorandum has furnished reliable information in the past.

Dick Gregory, identified as a noted civil rights worker and comedian, appeared at Southern Oregon College, Ashland, Oregon, gymnasium on February 23, 1970, at 8 p.m. Speaking to a crowd of approximately 1,600 people, he spoke primarily to today's youth. The address combined equal parts of comedy and comment and the result was a muddled gray confusion for many of the people present at the lecture. His material ranged from remarks about the difficulty he experienced getting to Ashland, Oregon, to comments on the stupidity of President Nixon and Vice-President Agnew. The majority of Gregory's humor was achieved by attacking the intelligence of others. The "gospel according to Gregory" describes Nixon, Agnew, the Supreme Court, police, American history, teachers, patriots and anybody left over as hopeless morons.

Comments made by Gregory included the statement that "Panthers aren't being killed because they're black, or because they're for self-defense. Panthers are killed because they're trying to feed the poor."

This document contains neither recommendations nor conclusions of the FBI. It is the property of the FBI and is loaned to your agency; it and its contents are not to be distributed outside your agency.

ALL INFORMATION CONTAINED
HEREIN IS UNCLASSIFIED
DATE 1-15-80 BY 2842 BMO/cal

ENCLOSURE 100-440423-530

RICHARD CLAXTON GREGORY

He suggested that our system of government, founded on the Constitution and the Declaration of Independence, should be implemented, not destroyed, saying, "I do not advocate beating the capitalistic system, but I do advocate beating it into its rightful position - behind the Constitution, not in front of it."

Gregory commented "people are worrying about certain groups taking over this country, when they should be worrying about the FBI and CIA."

Gregory suggested that he does not hate the white people as individuals, but he does hate the "white racists system."

Gregory complained about right-wing controlled newspapers, indicating they report slanted news.

Gregory's speech lasted for approximately two hours.

A characterization of the Black Panther Party is attached to the appendix.



UNITED STATES DEPARTMENT OF JUSTICE
FEDERAL BUREAU OF INVESTIGATION

WASHINGTON, D. C. 20535

In Reply, Please Refer to
File No.

March 13, 1970

Director
United States Secret Service
Department of the Treasury
Washington, D. C. 20220

Dear Sir:

The information furnished herewith concerns an individual who is believed to be covered by the agreement between the FBI and Secret Service concerning Presidential protection, and to fall within the category or categories checked.

1. Has attempted or threatened bodily harm to any government official or employee, including foreign government officials residing in or planning an imminent visit to the U. S., because of his official status.
2. Has attempted or threatened to redress a grievance against any public official by other than legal means.
3. Because of background is potentially dangerous; or has been identified as member or participant in communist movement; or has been under active investigation as member of other group or organization inimical to U. S.
4. U. S. citizens or residents who defect from the U. S. to countries in the Soviet or Chinese Communist blocs and return.
5. Subversives, ultrarightists, racists and fascists who meet one or more of the following criteria:
 - (a) Evidence of emotional instability (including unstable residence and employment record) or irrational or suicidal behavior;
 - (b) Expressions of strong or violent anti-U. S. sentiment;
 - (c) Prior acts (including arrests or convictions) or conduct or statements indicating a propensity for violence and antipathy toward good order and government.
6. Individuals involved in illegal bombing or illegal bomb-making.

Photograph has been furnished enclosed is not available
 may be available through _____

Very truly yours,

John Edgar Hoover
John Edgar Hoover
Director

1 - Special Agent in Charge (Enclosure(s))
U. S. Secret Service, Portland, Oregon.

Enclosure(s)

(Upon removal of classified enclosures, if any, this transmittal form becomes UNCLASSIFIED.)

*W. J. ...
6-14 ...*

3/23/70

Airtel

1 - Mr. Sullivan
1 - Mr. DeBruler

To: SAC, Salt Lake City (157-110)

From: Director, FBI (100-440423) - 531

EX-103

REC-128

RICHARD CLAXTON GREGORY
ARL
OO: CHICAGO

Re your airtel dated 3/17/70 under above caption.

Re airtel contains no information indicating basis for instituting an ARL investigation. Unless information is available to Salt Lake City indicating subject is traveling interstate for the purpose of inciting or organizing a riot, ARL investigation should be discontinued and this matter followed as an Intelligence matter in accordance with existing instructions.

1 - SAC, Chicago (For information)

WKD:drg
(6)

SEE NOTE PAGE TWO

ALL INFORMATION CONTAINED
HEREIN IS UNCLASSIFIED
DATE 1-15-80 BY 2842 PM/aw

MAILED 25
MAR 23 1970
COMM-FBI

- Tolson _____
- DeLoach _____
- Walters _____
- Mohr _____
- Bishop _____
- Casper _____
- Callahan _____
- Conrad _____
- Felt _____
- Gale _____
- Rosen _____
- Sullivan _____
- Tavel _____
- Soyars _____
- Tele. Room _____
- Holmes _____
- Gandy _____

3258
57 APR 1 1970

MAIL ROOM TELETYPE UNIT

[Handwritten signature]

NOTE:

Re airtel advised subject scheduled to appear at the University of Utah, Salt Lake City, in connection with "Challenge Week" 3/30/70 through 4/4/70 but contains no further information. Gregory has been the subject of an ARL investigation growing out of his participation during the violence at Chicago, Illinois, at the time of the Democratic National Convention. The United States Attorney with the concurrence of the Department declined Federal prosecution of Gregory. Gregory is the subject of Bufile 100-440423 and is on the agitator index.

F B I

Date: 3/17/70

Transmit the following in _____
(Type in plaintext or code)

Via AIRTEL REG. AIR MAIL
(Priority)

TO: DIRECTOR, FBI (100-440423)
FROM: SAC, SALT LAKE CITY (157-110)
RE: RICHARD CLAXTON GREGORY
ARL
(OO: Chicago)

Information has been received Subject is scheduled to appear at University of Utah, Salt Lake City, Utah, in connection with "Challenge Week," 3/30/70 through 4/4/70. The exact date of his appearance is unknown.

If Subject does appear as expected, his activities will be followed and reported.

- 2 - Bureau
- 2 - Chicago (176-31)
- 1 - Salt Lake City

WJG:mhe
(5)

ALL INFORMATION CONTAINED
HEREIN IS UNCLASSIFIED
DATE 1-15-80 BY 8842 DMJ/cal

EX-103

REC-128

100-440423-531

MAR 20 1970

(Handwritten signature)
SIX

Approved: _____
Special Agent in Charge

Sent _____ M Per _____

D

D

4-528

100-440423-532
CHANGED TO
100-439612-31X

MAY 26 1970

JW/EPB

C

F.B.I.

Date: 3/4/70

was red

Transmit the following in _____
(Type in plaintext or code)

Via AIRTEL _____
(Priority)

TO: DIRECTOR, FBI
FROM: SAC, CHARLOTTE (157-7455) (P)
RE: APPEARANCE OF RICHARD CLAXTON GREGORY
NORTH CAROLINA STATE UNIVERSITY
RALEIGH, NORTH CAROLINA
MARCH 2, 1970
RACIAL MATTERS

b6
b7C

Re Charlotte airtel to Director, 2/25/70.

Enclosed for the Bureau are 8 copies of LHM in captioned matter.

Copies are being disseminated locally to Secret Service and Military Intelligence agencies.

CE T-1 is [redacted] who personally attended both appearances of GREGORY, identity protected by request, and who furnished information to SA [redacted]

b6
b7C
b7D

CE T-2 is [redacted] North Carolina State University Raleigh, North Carolina (established contact), who furnished this information to SA [redacted] and requested identity be protected.

ALL INFORMATION CONTAINED HEREIN IS UNCLASSIFIED

201/2812/58m

REC-58

100-440423-538

- 2 - Bureau (Encl-8) (RM)
- 3 - Charlotte (2 - 157-7455)
- (1 - 157-177 SUB B)

8 MAR 7 1970

RRG:gs
(5)

AGENCY: ACSI, REG, OSI, SEC. SERV.,
DEPT. OF JUSTICE, IDIU, CO/2724
HOW FORW: [redacted]
DATE FORW: [redacted]
BY: [redacted]

RACIAL INT/SECT

Approved: *[Signature]*
56 MAR 31 1970 Special Agent in Charge

F B I

Date:

Transmit the following in _____
(Type in plaintext or code)

Via _____
(Priority)

CE 157-7455

Charlotte is attempting to determine if a recording was made of GREGORY's speeches. If so, it will be obtained, and the Bureau will be furnished copies of the transcription.

Approved: _____ Sent _____ M Per _____
Special Agent in Charge



UNITED STATES DEPARTMENT OF JUSTICE

FEDERAL BUREAU OF INVESTIGATION

Charlotte, North Carolina

March 4, 1970

In Reply, Please Refer to
File No.

APPEARANCE OF RICHARD CLAXTON GREGORY
NORTH CAROLINA STATE UNIVERSITY
RALEIGH, NORTH CAROLINA
MARCH 2, 1970
RACIAL MATTERS

Reference is made to memorandum submitted in this matter dated February 25, 1970, captioned as above.

On March 3, 1970, CE T-1 advised that from approximately 4:00 P. M. to 5:00 P. M. on March 2, 1970, RICHARD CLAXTON GREGORY spoke to approximately 150 to 175 persons at Erdahl-Cloyd Student Union on the campus of North Carolina State University at Raleigh, North Carolina. CE T-1 stated that GREGORY criticized the FBI, CIA, and United States Department of Health, Education and Welfare. He was critical of the capitalist "money men" of large northern industries mentioning the ROCKEFELLERS, DUPONTS, FORDS, etc. He cited examples that the Federal Government is withholding information concerning health hazards of food additives, drugs, and dangers of certain foods.

GREGORY discussed air pollution and praised the executive of a group of young people in Douglas, Arizona, threatening to blow up or burn a sulphur factory if they did not reduce the amount of air pollution.

THIS DOCUMENT CONTAINS NEITHER RECOMMENDATIONS NOR CONCLUSIONS OF THE FBI. IT IS THE PROPERTY OF THE FBI AND IS LOANED TO YOUR AGENCY; IT AND ITS CONTENTS ARE NOT TO BE DISTRIBUTED OUTSIDE YOUR AGENCY.

ALL INFORMATION CONTAINED
HEREIN IS UNCLASSIFIED
DATE 1-20-82 BY 2892/m/sem

100-440423-533

RE: APPEARANCE OF RICHARD CLAXTON GREGORY, NORTH CAROLINA STATE UNIVERSITY, RALEIGH, NORTH CAROLINA, MARCH 2, 1970

GREGORY stated that the "Patriots" and "Black Panthers" in Chicago got together to combine efforts toward a common goal and said the southern whites and blacks should get together.

There were no incidents.

CE T-1 stated that on the night of March 2, 1970, between approximately 8:00 P. M. and 10:00 P. M., GREGORY spoke at the Erdahl-Cloyd Union before approximately 800 to 1,000 people. According to CE T-1, some of GREGORY's comments are as follows:

GREGORY criticized the nominations of Judges HAYNESWORTH and CARSWELL to the United States Supreme Court. He criticized President NIXON and Vice president AGNEW. GREGORY said, "NIXON is the dumbest man in the history -- except for AGNEW." He was critical of the draft and patriots and stated patriots are now the oppressors.

GREGORY criticized the court in the trial of the "Chicago Seven." He compared that trial with trials in Russia and Nazi Germany. He stated that policemen are going to be killed when the new "No Knock Search Warrants" are used.

GREGORY accused the CIA of killing the KENNEDYS and MARTIN LUTHER KING and stated the FBI and CIA are attempting to take over the Government.

GREGORY commented concerning the racist society in the United States. He noted that page four of our passports prohibit travel to North Korea, North Vietnam, Mainland China, and Cuba because they are populated by people of a different color.

RE: APPEARANCE OF RICHARD CLAXTON GREGORY, NORTH CAROLINA STATE UNIVERSITY, RALEIGH, NORTH CAROLINA, MARCH 2, 1970

GREGORY stated, "A freedom that is not worth dying for is not worth having." GREGORY in closing encouraged those present to boycott different products and services to gain support ending the Vietnam War.

On March 4, 1970, CE T-2 advised that the appearance of RICHARD CLAXTON GREGORY on March 2, 1970, was part of the "contemporary scene lecture series" at North Carolina State University, Raleigh, North Carolina. CE T-2 stated arrangements for GREGORY's appearance were made through the American Program Bureau, Boston, Massachusetts, and GREGORY received \$1,250 for his appearances at North Carolina State University on March 2, 1970.

A characterization of the Black Panther Party is attached as an appendix to this memorandum.

BLACK PANTHER PARTY

According to its official newspaper, the Black Panther Party (BPP) was started during December, 1966, in Oakland, California, to organize black people so they can take control of the life, politics, and the destiny of the black community. It was organized by BOBBY GEORGE SEALE, BPP Chairman, and HUEY P. NEWTON, BPP Minister of Defense. NEWTON is presently serving a sentence of 2 to 15 years on a conviction of manslaughter in connection with the killing of an Oakland police officer.

The official newspaper, "The Black Panther," which further describes itself as the "Black Community News Service," states that the BPP advocates the use of guns and guerilla tactics in its revolutionary program to end oppression of the black people. Residents of the black community are urged to arm themselves against the police who are consistently referred to in the publication as "pigs" who should be killed.

"The Black Panther" issue of September 7, 1968, contains an editorial by BPP Minister of Education, GEORGE MASON MURRAY, which ends with the following:

"Black men. Black people, colored persons of America, revolt everywhere! Arm yourselves. The only culture worth keeping is a revolutionary culture. Change. Freedom everywhere. Dynamite! Black Power. Use the gun. Kill the pigs everywhere."

Included in the introduction to an article appearing in the October 5, 1968, edition of "The Black Panther" is the statement, "...we will not dissent from American Government. We will overthrow it."

Issues of "The Black Panther" regularly contain quotations from the writings of Chairman MAO Tse-tung of the People's Republic of China and feature MAO's statement that "political power grows out of the barrel of a gun."

The national headquarters of the BPP is located at 3106 Shattuck Avenue, Berkeley, California. Branches have been established at various locations throughout the United States.

#*



UNITED STATES DEPARTMENT OF JUSTICE

FEDERAL BUREAU OF INVESTIGATION

Charlotte, North Carolina

March 4, 1970

In Reply, Please Refer to
File No.

Title APPEARANCE OF RICHARD CLAXTON GREGORY
 NORTH CAROLINA STATE UNIVERSITY,
 RALEIGH, NORTH CAROLINA, MARCH 2, 1970

Character RACIAL MATTERS

Reference Memorandum prepared at Charlotte,
 North Carolina, dated and captioned
 as above.

All sources (except any listed below) whose identities
are concealed in referenced communication have furnished reliable
information in the past.

UNITED STATES GOVERNMENT

Memorandum

TO : DIRECTOR, FBI

DATE: 3/25/70

FROM : SAC, HONOLULU (157-NEW) (P)

~~CONFIDENTIAL~~

SUBJECT: RICHARD CLAXTON GREGORY, aka
Dick Gregory
RM
OO: Chicago

On 3/24/70, [redacted] who has furnished reliable information in the past, advised that DICK GREGORY is scheduled to appear at the University of Hawaii, Honolulu, on 4/17/70. Source advised that this appearance is sponsored by the Associated Students University of Hawaii, a legitimate student organization.

b7D

Chicago advise if they have any knowledge of GREGORY's travel plans to Honolulu. Also furnish Honolulu with suitable characterization of GREGORY for inclusion in LHM if necessary.

ALL INFORMATION CONTAINED
HEREIN IS UNCLASSIFIED
DATE 1-15-80 BY 2842 PMD/cab

- 2 - Bureau (RAM)
- 2 - Chicago (RAM)
- 1 - Honolulu

TC:esn
(5)

CLASS. & EXT. BY 2842 PMD/cab
REASON-FCIM II, 1-2.4.2
DATE OF REVIEW 3-25-90

REC-6

16 MAR 27 1970

60 APR 3 1970

~~CONFIDENTIAL~~

RACIAL INT. SECT.

See index

*5-7 Hm
Bufile # 5/19/70
JW*

(Handwritten initials)

4

F B I

Date: 3/25/70

Transmit the following in _____
(Type in plaintext or code)

Via AIRTEL _____ AIRMAIL _____
(Priority)

TO: DIRECTOR, FBI
FROM: SAC, TAMPA (157-3163)

rc
ses 4

CHANGED (IO)
RICHARD CLAXTON GREGORY
RACIAL MATTERS

100-440423-525

ReTPairtel to Bu, 2/13/70 re "DICK GREGORY,
RM". title changed to reflect subject's full name.

Campus source [redacted]

[redacted] Orlando, Fla. (Protect), advised on 3/24/70, that
GREGORY still scheduled for speaking engagement on 4/6/70,
but that the hours of arrival and departure have been
changed.

b6
b7C
b7D

LEADS

CHICAGO DIVISION

ALL INFORMATION CONTAINED
HEREIN IS UNCLASSIFIED
DATE 1-15-80 BY 8842 BMD/aw

AT CHICAGO, ILL.

ca

Will advise results of inquiry requested on 2/13/70.
Chicago is to also immediately advise Tampa if recording of
GREGORY's speech at this university should be obtained.

- 2 - Bureau (RM)
- 2 - Chicago (157-347) (RM)
- 3 - Tampa (2 - 157-3163)
(1 - 100-1423)

b6
b7C

TCA/by
(7)

REC-87 *15*

12 MAR 27 1970

[redacted] *440423-533X1*

RACIAL INT. SEC.

60 APR 13 1970

BB'S 1970

Approved: _____ Sent _____ M Per _____
Special Agent in Charge

UNITED STATES GOVERNMENT

Memorandum

TO : DIRECTOR, FBI (100-440423)

FROM : SAC, BUFFALO (157-396) (RUC)

SUBJECT: RICHARD CLAXTON GREGORY, aka
RM

DATE: 3/26/70

Enclosed for the Bureau are 11 copies, and for Chicago, 2 copies, of an LHM concerning captioned subject.

Enclosed LHM is not classified, since there is no apparent reason for so doing.

The confidential source mentioned in the enclosed LHM is [redacted]
[redacted]
[redacted] Alford, N.Y., who requested his identity be protected.

b6
b7C
b7D

Copies of this LHM are being furnished to Chicago, as Chicago is Office of Origin.

- 2 - Bureau (Encls. 11) (RM)
 - 2 - Chicago (Encls. 2) (RM)
 - 1 - Buffalo
- JFR;krd
(5)

4 - desk 5/21
1 - 8397

ALL INFORMATION CONTAINED
HEREIN IS UNCLASSIFIED
DATE 1-15-80 BY 2842 RML/ew

EX-111

REC 4

100-440423-534

AGENCY: ~~ACSI, OSI, SEC, SERV.~~
DEPT: ~~ISD, GR, IDIU, OS~~

HOW FORW: RS

DATE FORW: 4/6/70

BY: CAE/TJS

58 APR 1970

7258

RACIAL INT. SECT.





UNITED STATES DEPARTMENT OF JUSTICE
FEDERAL BUREAU OF INVESTIGATION

Buffalo, New York 14202
March 26, 1970

In Reply, Please Refer to
File No.

RICHARD CLAXTON GREGORY
RACIAL MATTER

On March 19, 1970, a confidential source, who has furnished reliable information in the past, made available a copy of the following press release, regarding the appearance of RICHARD CLAXTON GREGORY at the New York State University Agricultural and Technical College, Alfred, New York, on the evening of March 13, 1970:

"DICK GREGORY believes moral pollution, not air or water pollution, is the biggest problem facing this nation.

"The comic and author, who spoke on civil rights Friday night before a crowd of about 1000 at the State University Agricultural and Technical College at Alfred, declared:

'You live in the most insane nation on the face of the earth. And you have the task of giving her back her sanity, because America is not quite dead yet.

'Those who call her "America the Beautiful" are sick, sand and out of their cotton pickin' mind, and will be so long as our Indian brother is locked up on a reservation.'

"GREGORY continued, 'As long as the Indian is locked up, the Communist movement is going to look pretty good to a lot of people.'

"He asked his audience of primarily young people to 'work like hell' to put capitalism behind the constitution, instead of in front of it, and to 'put human rights ahead of property rights.

ALL INFORMATION CONTAINED
HEREIN IS UNCLASSIFIED
DATE 1-15-80 BY 2802 PML/cw

ENCLOSURE

100-440423-534

RICHARD CLAXTON GREGORY
RACIAL MATTER

'One question you have to ask,' said GREGORY, 'if democracy is as good as our generation tells you it is, why do we have to run around the world trying to ram it down the throats of other countries?'

'The people of my generation made a mistake when we were in college -- one I hope you will not make. We forgot to learn how to live because we were too busy learning how to make a living,' he observed.

"The 'comic with a cause' went on to touch on several current problems in this country.

"Concerning drugs, he said, 'Write to the Federal Bureau of Narcotics for literature. Then perhaps when your kids come to you, you will be able to do a better job than your parents did.'

'There are eight million alcoholics in America and yet nobody gives a damn about alcohol. As long as they (your parents) are doing it (drinking), it's okay.'

"He pointed out that drugs have been a problem in poor black communities for years, but that nobody became very upset until recently when in 'the best and richest families in America' were suddenly confronted with the fact that their youngsters were using drugs. He reported that statistics show that narcotic addiction in the black community today has decreased by 42%. 'You (whites) are living with the dope problem now,' he said.

"He talked of double standards in the case of Black Panther BOBBY SEALE, who was denied permission to act as his own defense counsel.

RICHARD CLAXTON GREGORY
RACIAL MATTER

"while in another case involving a white, the white was given this permission. He also compared the \$100,000.00 bail set for each of a group of Black Panthers, awaiting trial in New York, with the \$20,000.00 bail set for some 'white kids' who face similar charges.

"GREGORY then commented further on the Chicago Seven Trial, by declaring that Judge JULIUS HOFFMAN 'sent everybody to jail while the jury was out deliberating their verdict. What he did makes HITLER look like a saint,' said GREGORY. GREGORY called America a 'sick, degenerate nation,' whose people care about nothing but money. He noted that 'Black folks do not hate white folks, but do hate the white racist system.' He warned, however, that Blacks are going to hold all whites responsible for this system, because they permit it to exist.

"GREGORY's talk was interspersed with a humor that had his audience laughing at times, and applauding at other times, as he delivered his message effectively.

'You young people have to face all the problems our generation has created,' he stated. 'The establishment lies to you and when you catch them, they call it a generation gap. I'm here to inform you. When I leave, you'll be able to say, "At lease brother GREGORY didn't lie to us."

The confidential source said GREGORY did not make any inflammatory statements urging the audience to fight or take up arms. He advised that the audience was mixed, both racially and age-wise and also well behaved and orderly.

RICHARD CLAXTON GREGORY
RACIAL MATTER

This document contains neither recommendations nor conclusions of the FBI. It is the property of the FBI and is loaned to your agency; it and its contents are not to be distributed outside your agency.

100-440423-535
CHANGED TO
100-439612-31X1

MAY 26 1970

JW/ERB

C

F B I

Date: 3/27/70

Transmit the following in _____
(Type in plaintext or code)

Via AIRTEL REG. AIR MAIL
(Priority)

TO: DIRECTOR, FBI (100-440423)
FROM: SAC, SALT LAKE CITY (157-110)(P)
RE: RICHARD CLAXTON GREGORY
RM

rc

Re Salt Lake City airtel to Bureau, dated 3/17/70, and Bureau airtel to Salt Lake City, dated 3/23/70.

Subject is scheduled to appear at Special Events Center, University of Utah, Salt Lake City, Utah, on Monday, 3/30/70, at 8:00 pm. Topic of his talk will be "You've Got A Big Job." The appearance of GREGORY in Salt Lake City will be covered and results submitted.

★

- ② - Bureau
- 2 - Chicago (176-31)
- 2 - Salt Lake City

WJG:mhe
(6)

ALL INFORMATION CONTAINED
HEREIN IS UNCLASSIFIED
DATE 1-15-80 BY 2842 BMD/lmk

b6
b7c

REC-13/100-440423

10 MAR 31 1970

RACIAL INT. SEC.

Approved: 59 APR 7 1970
Special Agent in Charge

Sent _____ M Per _____

UNITED STATES GOVERNMENT

Memorandum

TO : DIRECTOR, FBI (100-440423)

FROM : SAC, MINNEAPOLIS (157-396) (RUC)

SUBJECT: RICHARD CLAXTON GREGORY aka
RM

DATE: 4/9/70

OO: CHICAGO

Enclosed for the Bureau are eight copies of an LHM concerning GREGORY's appearance in the Minneapolis Division at Duluth, Minnesota.

Enclosed for Chicago are two copies of above described LHM.

The source for information in the LHM is [redacted] Duluth, Minnesota, an established source for the Minneapolis Office.

b6
b7C
b7D

Photo Enclos

CC TO: 8-20-70

REQ. REC'D

AUG 25 1970

BY: WFW TS

Copy to SS, ZSD, IDIU, ZRS

by routing slip for

info action

date 4/17/70

by [signature]

REC-3

100-440423-537

- 2 - Bureau (Enc. 8) (RM)
 - 2 - Chicago (Enc. 2) (RM)
 - 1 - Minneapolis
- MOE:pm
(5)

APR 14 1970

RACIAL DIST. SECT.



55 APR 20 1970

Buy U.S. Savings Bonds Regularly on the Payroll Savings Plan.



UNITED STATES DEPARTMENT OF JUSTICE

FEDERAL BUREAU OF INVESTIGATION

Minneapolis, Minnesota 55401

In Reply, Please Refer to
File No. 157-386

April 9, 1970

RICHARD CLAXTON GREGORY

The Thursday, April 2, 1970, issue of the "Duluth News Tribune," published at Duluth, Minnesota, indicated that Gregory spoke at the Duluth Auditorium as a guest speaker for the Duluth Intra-City Student Council human relations workshop.

Gregory opened his remarks with statements against what he termed the "slimy, sick degeneracy" of America. Gregory charged that the older folks, or "old fools," have resorted to tricks with the young of America and left the young America with all the problems. Gregory stated that tricks have kept the white, conservative, money-and-power hungry segment of America in power. Gregory told the audience that "white folks have been tricking in this country for 400 years."

Gregory told the audience that he was left "cold" by right-wing Americans who espouse patriotism by pasting American flag decals on their cars, and charged these same people with tax evasion, hypocrisy, and beer drinking. He chastised America's youth for being the only young in the world "who don't give a damn about the worker."

In summation, Gregory called President Nixon "America's last trick" and "dumb boy." Gregory stated that he found fault with a system that lies to young people every day and termed the lie a "generation gap." He charged that "institutionalized racism" is "choking the black people to death." He claimed that men in power get special privileges,

ALL INFORMATION CONTAINED
HEREIN IS UNCLASSIFIED
DATE 7-10-80

BY 284 pmv /efm

100-440423-537

ENCLOSURE

RICHARD CLAXTON GREGORY

especially with regard to the draft. Gregory advised that the only way America is going to get out of its insane state is to use its greatest weapon: the U.S. Constitution.

A source, who has furnished reliable information in the past, advised that Gregory's speech at the Duluth Auditorium was attended by about 1,200 students. Gregory was paid \$1,250.00 for his appearance.

THIS DOCUMENT CONTAINS NEITHER
RECOMMENDATIONS NOR CONCLUSIONS OF
THE FBI. IT IS THE PROPERTY OF
THE FBI AND IS LOANED TO YOUR AGENCY;
IT AND ITS CONTENTS ARE NOT TO BE
DISTRIBUTED OUTSIDE YOUR AGENCY.

FBI

Date: 3/13/70

Transmit the following in _____
(Type in plaintext or code)

Via AIRTEL _____
(Priority)

TO: DIRECTOR, FBI
FROM: SAC, NEW HAVEN (157-1780) (RUC)
SUBJECT: BLACK ARTS FESTIVAL
BROWN UNIVERSITY
PROVIDENCE, RHODE ISLAND
MARCH, 1970
RM

ALL INFORMATION CONTAINED
HEREIN IS UNCLASSIFIED
DATE 1-15-80 BY 28420/SLC

Re: New Haven airtel and LHM, 3/4/70.

Enclosed for the Bureau are 15 copies of an LHM dated and captioned as above. Enclosed for Boston are 5 copies of the same LHM. Enclosed for Newark, New York, and Chicago, are four copies each of the same LHM.

The enclosed LHM is classified confidential in order to protect a highly sensitive source of continuing value.

The source made reference to in the enclosed LHM is NH 605-R* who reports on the activity of the BPP, New Haven Chapter, 35 Sylvan Avenue, New Haven, Connecticut.

(CC AT 4/1/70 926942)

- 6- Bureau (2- 157- BLACK ARTS FESTIVAL) (Enc. 15)
 - (1- 100-443566 J. FORMAN)
 - (1- 100-440423 D. GREGORY)
 - (1- 105-165706-32 BPP)
 - (1- 100-425307 LE ROI JONES)
- 5- Boston (2- 157- BLACK ARTS FESTIVAL) (Enc. 5)2
 - (1- 157-654 BPP) (1- 157- [redacted])
 - (1- 157- [redacted])
- 3- New Haven (1- 157-1780)
 - (1- 157-1462)
 - (1- 100-19186)

(SEE PAGE TWO FOR COPIES)

AGENCY: ACSI, ONI, OSI,
SEC. SER.: RAO (1SD, CRD, 1D10)
DATE FORWARD: 3-20-70
HOW FORWARD: P/S

NOT RECORDED

MAR 24 1970

30 APR 8 1970 35

Sent _____ M Per _____

Special Agent in Charge

b6
b7C

ORIGINAL FILED
157-16778-7

b6
b7C

ENCLOSURE

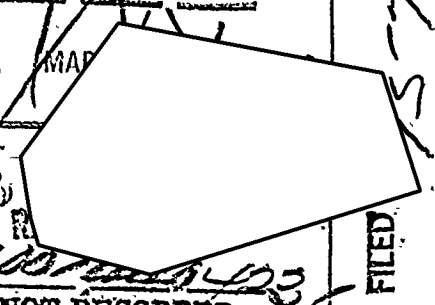
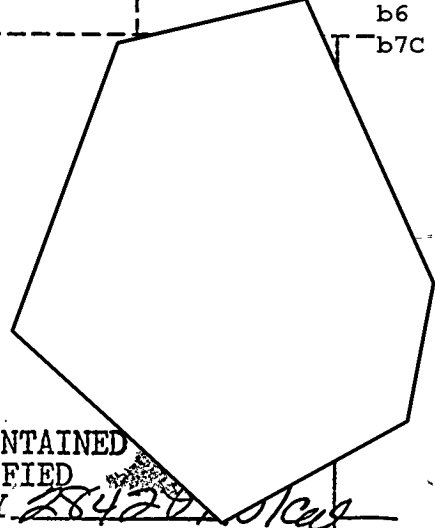

COPIES (continued)

- 4- Chicago (2- 157- BLACK ARTS FESTIVAL) (Enc. 4)
(2- 157-347 D. GREGORY)
- 4- Newark (2- 157- BLACK ARTS FESTIVAL) (Enc. 4)
(2- 100-42539 LE ROI JONES)
- 4- New York (2- 157- BLACK ARTS FESTIVAL) (Enc. 4)
(2- 100-155090 JAMES FORMAN)

In addition to the information which is paraphrased in the enclosed LHM concerning the Black Arts Festival, receiving offices will note the following additional information:

The information furnished by the source was a conversation between [redacted]

b6
b7C
b7D

[redacted] The information in the enclosed LHM pertaining [redacted] was information related to [redacted]

[redacted] stated that a student named [redacted] who has contacts in New York was [redacted] that [redacted] for a wedding and would get in touch [redacted]

THIS INFORMANT IS BEING OPERATED UNDER DEPARTMENTAL AUTHORIZATION. INFORMATION OBTAINED FROM THIS INFORMANT IS CLASSIFIED CONFIDENTIAL. SHOULD IT BE NECESSARY TO DISSEMINATE THIS INFORMATION OUTSIDE THE BUREAU, IT SHOULD BE APPROPRIATELY PARAPHRASED IN ORDER TO ADEQUATELY PROTECT THIS HIGHLY SENSITIVE SOURCE.

Any additional information obtained by New Haven through NH 605-* concerning the Black Arts Festival will be furnished by appropriate communication.

NH 157-1780

Copies of this LHM are furnished to Chicago, Newark, and New York, inasmuch as copies of referenced New Haven airtel and LHM were furnished to those offices with regard to DICK GREGORY, LE ROI JONES, and JAMES FORMAN.



UNITED STATES DEPARTMENT OF JUSTICE

FEDERAL BUREAU OF INVESTIGATION

510 Trust Company Building
New Haven, Connecticut 06510

March 13, 1970

In Reply, Please Refer to
File No.

~~CONFIDENTIAL~~

RE: BLACK ARTS FESTIVAL
BROWN UNIVERSITY
PROVIDENCE, RHODE ISLAND
MARCH, 1970

Reference is made to memorandum dated March 4, 1970, entitled as above.

On March 12, 1970, a source, who has furnished reliable information in the past, advised that Brown University did not want to donate any more money towards the Black Arts Festival until it received the \$27,000 which had already been spent toward the festival. According to this source, there was thus no additional money available for the festival and only \$15,000 had been realized from ticket sales for the festival. The source pointed out that more than \$10,000 was needed to break even.

This source further pointed out that the Religious Studies Department of Brown University was sponsoring JAMES FORMAN, who according to the source would speak on reparation. This source further advised that the Music Department of Brown University was paying for the lecture which was scheduled to be given by CANNONBALL ADDERLY and that the Rhode Island School of Design was paying for the exhibition. According to this source, any profit realized from the festival was supposed to go back into the Student Activities Account of the University.

~~CONFIDENTIAL~~

GROUP I

DECLASSIFIED

BY 6855

17-29-77 Dml/ellc

Excluded from automatic
downgrading and declassification.

This document contains neither
recommendations nor conclusions
of the FBI. It is the property
of the FBI and is loaned to your
agency; it and its contents are
not to be distributed outside
your agency.

100-440623
ENCLOSURE

BLACK ARTS FESTIVAL
BROWN UNIVERSITY
PROVIDENCE, RHODE ISLAND
MARCH, 1970

~~CONFIDENTIAL~~

This source further advised that the Black Panther Party (BPP) intended to be represented at the festival under any circumstances and that they wanted room at the festival for an information center. Source pointed out that the Black Panther Party would probably be represented at the festival during the busy period and that there would be at least five members of the BPP present from Connecticut in addition to some high school students.

A characterization of the
BPP appears in the Appendix.

This source advised that it was expected that approximately two or three thousand people would be at the festival.

~~CONFIDENTIAL~~

APPENDIX~~CONFIDENTIAL~~BLACK PANTHER PARTY, aka
Black Panther Party for Self-Defense

According to its official newspaper, the Black Panther Party (BPP) was started during December, 1966, in Oakland, California, to organize black people so they can take control of the life, politics and the destiny of the black community. It was organized by BOBBY GEORGE SEALE, BPP Chairman, and HUEY P. NEWTON, BPP Minister of Defense. NEWTON is presently serving a sentence of two to fifteen years on a conviction of manslaughter in connection with the killing of an Oakland police officer.

The official newspaper, "The Black Panther," which further describes itself as the "Black Community News Service," stated that the BPP advocates the use of guns and guerrilla tactics in its revolutionary program to end oppression of the black people. Residents of the black community are urged to arm themselves against the police who are consistently referred to in the publication as "pigs" who should be killed.

"The Black Panther" issue of September 7, 1968, contains an editorial by BPP Minister of Education, GEORGE MASON MURRAY which ends with the following:

"Black Men. Black people, colored persons of America, revolt everywhere! Arm yourselves. The only culture worthkeeping is revolutionary culture. Change. Freedom everywhere. Dynamite! Black Power. Use the gun. Kill the pigs everywhere!"

Included in the introduction to an article appearing in the October 5, 1968, edition of "The Black Panther" is the statement, "...We will not dissent from American Government. We will overthrow it."

Issues of the "Black Panther" regularly contain quotations from the writings of Chairman MAO Tse-tung of the People's Republic of China and feature MAO's statement that "political power grows out of the barrel of a gun."

The national headquarters of the BPP is located at 3106 Shattuck Avenue, Berkeley, California. Branches have been established at various locations throughout the United States.

~~CONFIDENTIAL~~

~~CONFIDENTIAL~~
~~CONFIDENTIAL~~

Date: 4/7/70

Transmit the following in _____
(Type in plaintext or code)

Via AIRTEL AIR MAIL
(Priority)

TO: DIRECTOR, FBI (100-440423)
FROM: SAC, KNOXVILLE (157-1523) (P)
RICHARD CLAXTON GREGORY
RM
(OO: CHICAGO)

Re Knoxville airtel to Director dated 3/5/70 captioned
"WILLIAM M. KUNTSLER, SM - MISCELLANEOUS" and "RICHARD CLAXTON
GREGORY, RM."

[redacted] who has furnished reliable information
in the past and an [redacted]
Knoxville, Tennessee, advised SA JOSEPH L. FLEMING 4/6/70
that he had been appointed to the reception committee to
meet GREGORY when he arrives by plane at the McGhee Tyson
Airport, Knoxville, Tennessee, and to escort him while he is
in Knoxville, Tennessee. (U)

GREGORY is to speak at UT, Knoxville, night of
4/9/70.

Bureau and Chicago will be kept advised of any
pertinent developments.

- 2 - Bureau (RM)
- 2 - Chicago (157-347) (RM)
- 3 - Knoxville (1 - [redacted])

HAM/cyp
(7)

1-15-80
CLASS. & EXT. BY 2842 PMU/kab
REASON-FCIM II, 1-2.4.2
DATE OF REVIEW 4-7-90

REC 27 100-440423-538

3 APR

59 APR 16 1970

~~CONFIDENTIAL~~

Approved: _____ Sent _____ M Per _____
Special Agent in Charge

b6
b7C
b7D

b6
b7C
b7D

4487 4 510

8

FBI

Date: 4/8/70

Transmit the following in _____
(Type in plaintext or code)

Via AIRTEL AIRMAIL
(Priority)

et
TO: DIRECTOR, FBI (100-440423)
FROM: SAC, ALBANY (157-253) (P)
RE: RICHARD CLAXTON GREGORY, aka
Dick Gregory
(AGITATOR INDEX)
RM

(OO: Chicago)

Enclosed for the Bureau are 8 copies of an LHM revealing the expected appearance of subject at Burlington, Vermont; on 4/12/70. There is no indication that there will be any demonstration or violence and this matter will be followed and LHM submitted. *8*

Copy of LHM has been furnished to 108th MIG, Burlington, Vermont, and Secret Service, Boston, Mass. Local authorities cognizant.

ENCLOSURE
2-Bureau (Encs. 8) (RM)
2-Chicago (157-347) (Encs. 2) (RM)
2-Albany
ACA:ad
(6)
*3 desk copy
1-8047*

100-440423-539

REC 27

8 APR 10

Copy to ISD, IDIU, SS
by routing slip for:
 info action
date 4/13/70
by Coffin

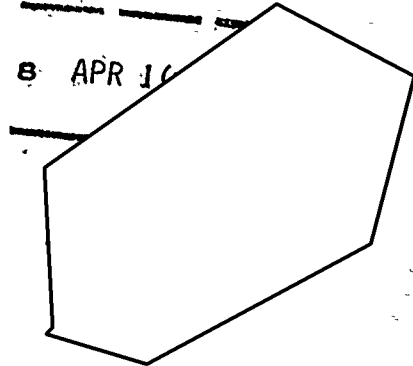

b6
b7c

56 APR 11 1970
Approved: [Signature]
Special Agent in Charge

Sent _____ M Per _____



UNITED STATES DEPARTMENT OF JUSTICE
FEDERAL BUREAU OF INVESTIGATION

In Reply, Please Refer to
File No.

Albany, New York

April 8, 1970

RICHARD CLAXTON GREGORY, also known as
Dick Gregory

[redacted]
[redacted] Vermont, advised on April 8, 1970,
that DICK GREGORY is scheduled to appear at the University
of Vermont for a discussion which is to take place at 8 PM,
on April 12, 1970. His appearance is sponsored by the
Student Activities Committee of the University of Vermont.

b6
b7c

This document contains neither recommendations
nor conclusions of the FBI. It is the
property of the FBI and is loaned to your
agency; it and its contents are not to be
distributed outside your agency.

-1*

100-440423-539
ENCLOSURE

F B I

Date: 4/8/70

Transmit the following in _____
(Type in plaintext or code)

Via AIRTEL _____
(Priority)

TO: DIRECTOR, FBI (100-440423)
FROM: SAC, SAVANNAH (157-1293) (P)
SUBJ: RICHARD CLAXTON GREGORY
RM - BN

Re Savannah radiogram to Bureau dated 3/30/70, entitled "BLACK NATIONALIST MOVEMENT IN THE UNITED STATES, RACIAL CALENDAR," and Bureau 0-1 form dated 3/31/70.

Enclosed herewith are eight copies of an LHM captioned as above and suitable for dissemination and 2 copies of FD-376.

Copies of the LHM have also been designated for 111th MIG, Ft. McPherson, Ga.; OSI Robins AFB, Ga.; NISO, Charleston, S. C.; U. S. Secret Service, Atlanta, Ga.

SV T-1 is [redacted] Augusta, Ga., who attended for the [redacted]

8 ENCLOSURE

3 destroyed

REC-112

b6
b7C
b7D

2 Bureau (Enc. 8) (RM)
3- Savannah
(1- [redacted])

100-440423-540

CMD/dmm
(5)

AGENCY: ~~ACST, NEG, OSI~~, SEC, SERV.,
DEPT: ~~ISD, CEN, IDIU~~, IDIU, ~~SI~~
HOW FORW: R/S
DATE FORW: 4/15/70
BY: CAF/JRS

[Large redacted area]

b6
b7C

6 APR 22 1970 #299

Approved: _____ Sent _____ M Per _____
Special Agent in Charge

3
1
1
5
3
8



UNITED STATES DEPARTMENT OF JUSTICE
FEDERAL BUREAU OF INVESTIGATION

In Reply, Please Refer to
File No.

WASHINGTON, D.C. 20535

Savannah, Georgia
April 8, 1970

Director
United States Secret Service
Department of the Treasury
Washington, D. C. 20220

Dear Sir:

The information furnished herewith concerns an individual who is believed to be covered by the agreement between the FBI and Secret Service concerning Presidential protection, and to fall within the category or categories checked:

1. Has attempted or threatened bodily harm to any government official or employee, including foreign government officials residing in or planning an imminent visit to the U. S., because of his official status.
2. Has attempted or threatened to redress a grievance against any public official by other than legal means.
3. Because of background is potentially dangerous; or has been identified as member or participant in communist movement; or has been under active investigation as member of other group or organization inimical to U. S.
4. U. S. citizens or residents who defect from the U. S. to countries in the Soviet or Chinese Communist blocs and return.
5. Subversives, ultrarightists, racists and fascists who meet one or more of the following criteria:
 - (a) Evidence of emotional instability (including unstable residence and employment record) or irrational or suicidal behavior;
 - (b) Expressions of strong or violent anti-U. S. sentiment;
 - (c) Prior acts (including arrests or convictions) or conduct or statements indicating a propensity for violence and antipathy toward good order and government.
6. Individuals involved in illegal bombing or illegal bomb-making.

Photograph has been furnished enclosed is not available
 may be available through _____

Very truly yours,

John Edgar Hoover
Director

1 - Special Agent in Charge (Enclosure(s))
U. S. Secret Service , Atlanta, Georgia (RM)

Enclosure(s)

(Upon removal of classified enclosures, if any, this transmittal form becomes UNCLASSIFIED.)



UNITED STATES DEPARTMENT OF JUSTICE
FEDERAL BUREAU OF INVESTIGATION

Savannah, Georgia
April 8, 1970

In Reply, Please Refer to
File No.

RICHARD CLAXTON GREGORY

Chief of Police Broadus L. Bequest, Augusta Police Department, Augusta, Georgia, advised on March 30, 1970, that comedian Dick Gregory delivered a speech at Paine College Memorial Chapel, Augusta, Georgia, on March 26, 1970, at 8:00 PM. Chief Bequest explained that Gregory was on a nation-wide speaking tour of college campuses and tickets were sold with the proceeds going to a scholarship fund for the college. He stated there were no incidents and that Gregory's remarks were delivered in a humorous vein, but intended to make a serious point.

On April 6, 1970, SV T-1, [redacted] advised he attended an open meeting at Memorial Chapel, Paine College, Augusta, Georgia, on the evening of March 26, 1970, when Dick Gregory, the comedian and commentator spoke. Source said this was a one-night stand for Gregory, and this was part of a nation-wide tour of college campuses by Gregory. He said tickets were sold for the event with the proceeds going to a scholarship fund for the college. Source said there were no incidents of violence or confrontations in connection with this appearance of Gregory at Paine College, where he spoke to about 900 individuals.

b6
b7C
b7D

Source said Gregory's talk involved serious thoughts put across through the use of humor, and appeared to be more or less guidelines for self-improvement of black people. He frequently appealed to the self-respect and dignity of black people. Source said Gregory gave a recitation at one

This document contains neither recommendations nor conclusions of the FBI. It is the property of the FBI and is loaned to your agency; it and its contents are not to be distributed outside your agency.

ENCLOSURE

100-440423-540

RICHARD CLAXTON GREGORY

point in his talk, where he stated in effect that if the people of this country do not think the Government in power is the best form of Government for the people, the people have a right and duty to overthrow that Government. Source said after Gregory had presented this recitation in a very emotional manner, he then explained he was reciting from the Declaration of Independence.

According to source, it was difficult at times to pinpoint just what Gregory was advocating, because he frequently referred to "crackers" and "niggers", but the intent of his remarks was not clear. He referred to police in general as "Pigs", and indicated police were first called "Pigs" in the Bible, referring to the incident where the evil spirits were caused to leave the sick man, going into a herd of swine, which thereafter ran off a cliff and were destroyed.

Source said Gregory also spoke of the Northern white man using the Southern white man. He said the Northern white man sold the black slaves to the Southern white man, while that was profitable for the Northern white man. Then when it was no longer profitable for the Northern white man, he said to the Southern white man that he could no longer have slaves. He said the Southern white man did not have enough intelligence to see that he was being used by the Northern white man, who is now using both the black citizens and the Southern white man.

Gregory spoke of the history of violence in this country from the time of Plymouth Rock to the present. He said the white man had run the Indian off his land, and now has the Indians confined to the small reservations. He said the Europeans look upon the white man in this country as savages because of the treatment of the Indians by the white man. He also mentioned the mistreatment of the Mexican laborers in this country, particularly those working on grape farms in California.

Source said Gregory praised the Negro woman for her stability and what she has meant to the Negro race in this country. He said the black man should give her respect which she has earned and deserves.

RICHARD CLAXTON GREGORY

Source said Gregory stated the white middle-class of this country put President Nixon in office and the white middle-class will vote him out of office. Gregory said Vice President Agnew must be pretending because Gregory did not believe the Vice President could be as dumb as he appears unless he is trying to appear that way.

Source said that during the approximately two hours that Gregory spoke, he made attacks on virtually every segment of American society - including the schools, the teachers, professional people, preachers, the "Uncle Toms". These attacks were mainly for lack of involvement and concern. He said Gregory stated that he does not preach or advocate violence, but neither does he back up from it.

111th Military Intelligence Group, Ft. McPherson, Georgia; Office of Special Investigations, Robins Air Force Base, Georgia; Naval Investigative Service Office, Charleston, South Carolina; and United States Secret Service, Atlanta, Georgia, have been advised of the above.



In Reply, Please Refer to
File No.

UNITED STATES DEPARTMENT OF JUSTICE
FEDERAL BUREAU OF INVESTIGATION
Savannah, Georgia
April 8, 1970

Title RICHARD CLAXTON GREGORY

Character RACIAL MATTERS - BLACK NATIONALIST

Reference Savannah memorandum dated April 8,
1970, captioned as above.

All sources (except any listed below) whose identities are concealed in referenced communication have furnished reliable information in the past.

WSA

FEDERAL BUREAU OF INVESTIGATION
COMMUNICATIONS SECTION

NR 005 BA CODE

741PM URGENT 4-8-70 LLF

APR 8 1970 *ellh*

TO DIRECTOR

TELETYPE

ATT DOMESTIC INTELLIGENCE

FROM BALTIMORE (157-2722)

Mr. Tolson	_____
Mr. DeLoach	_____
Mr. Walters	_____
Mr. Mohr	_____
Mr. Bishop	_____
Mr. Casper	_____
Mr. Callahan	_____
Mr. Conrad	_____
Mr. Felt	_____
Mr. Gale	_____
Mr. Rosen	_____
Mr. Sullivan	<i>[initials]</i>
Mr. Tavel	<i>[initials]</i>
Mr. Soyars	_____
Tele. Room	_____
Miss Holmes	_____
Miss Gandy	_____

b6
b7C

APPEARANCE OF NATIONALLY KNOWN COMEDIAN DICK GREGORY
AT MORGAN STATE COLLEGE, BALTIMORE, MARYLAND, APRIL NINE
SEVENTY. RM.

ON APRIL EIGHT INSTANT, A CONFIDENTIAL RELIABLE SOURCE
ADVISED NATIONALLY KNOWN COMEDIAN DICK GREGORY IS SCHEDULED
TO ADDRESS STUDENT BODY OF MORGAN STATE COLLEGE, A
PREDOMINANTLY NEGRO COLLEGE, BALTIMORE, MARYLAND, AT ONE PM
ON APRIL NINE NEXT.

LOCAL AUTHORITIES COGNIZANT.

ONE ZERO NINTH MIGP, SECRET SERVICE, AND USA, ALL
BALTIMORE, ADVISED.

ADMINISTRATIVE

BALTIMORE FOLLOWING.

SOURCE REFERRED TO ABOVE IS

(R PROB).

IF NO INFORMATION OF A POSITIVE NATURE IS DEVELOPED

END PAGE ONE

TELETYPED TO: *[initials]*
ENCLOSURE
APR 21 1970

XEROX
APR 1970

~~MR. DELOACH FOR THE DIRECTOR~~

ABR

COPY SENT

(EDU)

REC-62

100-440423-541

9 APR 15 1970

b7D

PAGE TWO

RE ANY INFLAMATORY STATEMENTS WHICH MAY BE MADE BY GREGORY
AND IF NO OTHER ACTION SUBSEQUENTLY RESULTS, NO LHM WILL BE
SUBMITTED, UACB.

END

WA FOR TWO

REW FBI WASH DC

FOR TWO CLR

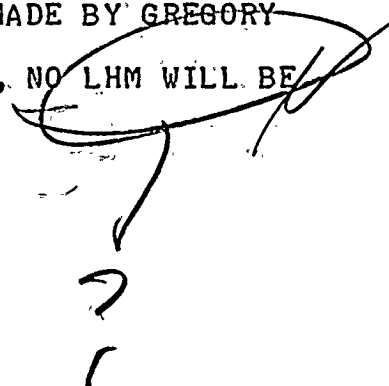
A large handwritten scribble in black ink is present on the right side of the page. It starts with a large loop that encircles the words "NO LHM WILL BE" in the second line of the main text. From the bottom of this loop, a line extends downwards, ending in a small hook-like shape. Below this hook, there are two more small, vertically aligned marks that resemble the number "7" and the number "1".

CC- MR. SULLIVAN

4/15/70

Airtel

- 1 - Mr. W. C. Patterson
- 1 - Field Guidance Folder
- 1 -

b6
b7c

To: SAC, Baltimore

From: Director, FBI (100-440423)

RICHARD CLAXTON GREGORY
RACIAL MATTERS

ReBate1 4/8/70 captioned "Appearance of Nationally Known Comedian, Dick Gregory, at Morgan State College, Baltimore, Maryland, 4/9/70; RM."

For your information and future guidance, there is wide Government interest in the public appearances of all black extremists. Many Government leaders and agencies rely on the FBI for this type of intelligence data. Therefore, whenever you learn of any such appearances in your territory, you should promptly submit that information in a form suitable for dissemination.

Concerning captioned individual, he has been arrested on numerous occasions in connection with his civil rights activities and has vehemently criticized the war in Vietnam, the President, and the Director. He has spoken at numerous colleges and universities throughout the United States, and his main theme usually centers on the youth and what they can do to correct the white racist establishment in the United States. The subject is on the Agitator Index in view of his past activities.

Submit results of subject's speaking appearance at Morgan State College in a form suitable for dissemination. In this connection, the Bureau desires a summary of his activities, however, any inflammatory statements should be set forth verbatim.

1 - Chicago (157-347)

CAF:gas/aeb
(7)

REC-96

19 APR 16 1970
SEE NOTE PAGE TWO

ALL INFORMATION CONTAINED
HEREIN IS UNCLASSIFIED
DATE 1-10-80 BY 2842 Pm/Emm

MAIL ROOM TELETYPE UNIT

MAILED 20
APR 15 1970
COMM

APR 21 1970

J

O

gc

100-440423-542

[Handwritten initials]

Airtel to Baltimore
Re: - Richard Claxton Gregory
100-440423

NOTE:

Baltimore Office indicated that results of subject's appearance would not be incorporated in LHM; therefore, above instructions appear necessary.

FEDERAL BUREAU OF INVESTIGATION
FOI/PA
DELETED PAGE INFORMATION SHEET
FOI/PA# 1206535-0

Total Deleted Page(s) = 9

- Page 24 ~ b1 - per ARMY;
- Page 25 ~ b1 - per ARMY;
- Page 26 ~ b1 - per ARMY;
- Page 27 ~ b1 - per ARMY;
- Page 28 ~ b1 - per ARMY;
- Page 29 ~ b1 - per ARMY;
- Page 30 ~ b1 - per ARMY;
- Page 31 ~ b1 - per ARMY;
- Page 184 ~ b1; b3;

```
XXXXXXXXXXXXXXXXXXXXXXXXXXXXX  
X Deleted Page(s) X  
X No Duplication Fee X  
X For this Page X  
XXXXXXXXXXXXXXXXXXXXXXXXXXXXX
```



DEPARTMENT OF STATE

Washington, D.C. 20520

June 11, 1969

FBI LIAISON:

FOR INFORMATION ONLY

RE:

Richard Claxton GREGORY

BORN:
PLACE:



b6 per Dept. of State

RESIDENCE:

1451 East 55th Street
Chicago, Illinois 60615

BUREAU FILE NUMBER:

Unknown 100-440423

WASHINGTON FIELD OFFICE:

Unknown

PASSPORT NUMBER:

K-761916 issued June 5, 1969
at Chicago

ATTORNEY:

TRAVEL PLANS

PORT OF DEPARTURE:

Unknown

DATE OF DEPARTURE:

June 7, 1969

MEANS OF TRANSPORTATION:

Air

PROPOSED LENGTH OF STAY:

2-3 Weeks

100-440423

COUNTRIES TO BE VISITED:

London, England

PURPOSE OF TRIP:

Business

J

PASSPORT OFFICE

Robert D. Johnson

100-440423-

NOT RECORDED

12 JUN 27 1969

Copy to Chicago
by routing slip for
 info action
date 6/27/69

55 JUN 30 1969

June 11, 1969

FBI LIAISON:

FOR INFORMATION ONLY

RE:

Richard Claxton GREGORY

BORN:
PLACE:

[REDACTED] b6 per Dept. of State

RESIDENCE:

1451 East 55th Street
Chicago, Illinois 60615

BUREAU FILE NUMBER:

Unknown

WASHINGTON FIELD OFFICE:

Unknown

PASSPORT NUMBER:

K-761916 issued June 5, 1969
at Chicago

ATTORNEY:

TRAVEL PLANS

PORT OF DEPARTURE:

Unknown

DATE OF DEPARTURE:

June 7, 1969

MEANS OF TRANSPORTATION:

Air

PROPOSED LENGTH OF STAY:

2-3 Weeks

COUNTRIES TO BE VISITED:

London, England

PURPOSE OF TRIP:

Business

PASSPORT OFFICE
Robert D. Johnson

OPTIONAL
MAY 1962 EDITION
GSA GEN. REG. NO. 27

5010-106

UNITED STATES GOVERNMENT

Memorandum

TO : Director, FBI ()

ATTN:

DATE: 10/8/69

~~CONFIDENTIAL~~

FROM : (U) [Redacted]

b7E

SUBJECT: DICK GREGORY
SM - ANA
(NEW LEFT - FOREIGN INFLUENCE)
(OO: CG)

[Redacted]

b1 per ARMY
(C)

Request enclosure(s) _____ be translated in summary
 verbatim and enclosure(s) and translation sent to interested field division.

[Redacted]

(C)

[Large Redacted Area]

(C) b1 per ARMY

3-86
T. EX 1168 bks / 45m
IN 1-2.4.2 2
LT 10-8-89

440423

RECORDED

CT 10 1969

b6
b7C

APPROPRIATE AGENCIES AND FIELD OFFICES ADVISED BY ROUTING SLIP(S)
CN 1-3/20

2 - Bureau (Enc. 1)
1 - [Redacted] b7E

JCFM:ner

53 OCT 21 1969

ENCLOSURE | Copy to Chicago by 10/15/69
by routing slip for
 info action
date 10/15/69
by C.A.F. [Signature]

~~CONFIDENTIAL~~

FEDERAL BUREAU OF INVESTIGATION
FOI/PA
DELETED PAGE INFORMATION SHEET
FOI/PA# 1206535-0

Total Deleted Page(s) = 8
Page 17 ~ Referral/Consult;
Page 18 ~ Referral/Consult;
Page 103 ~ b6; b7C; b7D;
Page 110 ~ Referral/Consult;
Page 111 ~ Referral/Consult;
Page 112 ~ Referral/Consult;
Page 113 ~ Referral/Consult;
Page 171 ~ Referral/Consult;

XXXXXXXXXXXXXXXXXXXXXXXXXXXXX
X Deleted Page(s) X
X No Duplication Fee X
X For this Page X
XXXXXXXXXXXXXXXXXXXXXXXXXXXXX

F B I

Date: 4/13/70

Transmit the following in _____
(Type in plaintext or code)

Via AIRTEL REG. AIR MAIL
(Priority)

TO: DIRECTOR, FBI (100-440423)
FROM: SAC, SALT LAKE CITY (157-110)(RUC)
RE: RICHARD CLAXTON GREGORY
RM
(OO: Chicago)

TDR

Re Salt Lake City airtels to Bureau, dated 3/17/70 and 3/27/70.

Transmitted herewith to Bureau are eleven copies and to Chicago are two copies of an LHM pertaining to the appearance of Subject in Salt Lake City, Utah, on 3/30/70.

A complete tape of GREGORY's remarks was furnished the Salt Lake City Office by _____ at the University of Utah, Salt Lake City, and is maintained in Salt Lake City Office. Inasmuch as pertinent statements made by GREGORY are reflected in the FD-302 which is part of the LHM, the tape is not being transcribed.

B

I destroyed
1 copy
ENCLOSURE

b6
b7c

- 2 - Bureau (Enc. 11)
- 2 - Chicago (Enc. 2)(176-31)
- 2 - Salt Lake City

REG 102

WJG:mhe

(6) ALL INFORMATION CONTAINED
HEREIN IS UNCLASSIFIED
DATE 1-10-80 BY 2842 PMV/SPM

100-440423-543

AGENCY: ACSI, NEC, OSI, SEC, SERV.,
DEPT: ISD, SAS, RAO, IDIU, SD

HOW FORW: _____
DATE FORW: 4/20/70
BY: CAF/JRS

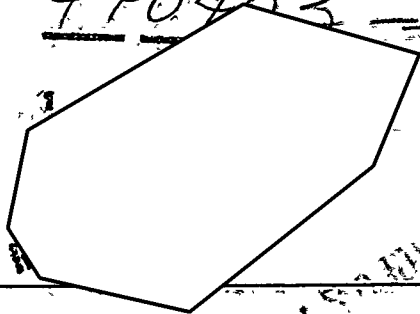

60 APR 24 1970

Approved: _____ Sent _____ M Per _____
Special Agent in Charge



UNITED STATES DEPARTMENT OF JUSTICE
FEDERAL BUREAU OF INVESTIGATION

In Reply, Please Refer to
File No.

Salt Lake City, Utah
April 13, 1970

RICHARD CLAXTON GREGORY

On March 17, 1970, [redacted]

[redacted] University of Utah, Salt Lake City, Utah, advised that Richard Claxton Gregory was scheduled to appear at the Special Events Center at the university on Monday, March 30, 1970, in connection with the university's "Challenge Week." The title of his talk will be "You've Got A Big Job."

The following article appeared in the "Daily Utah Chronicle," a daily newspaper published at the University of Utah, on March 31, 1970:

ALL INFORMATION CONTAINED
HEREIN IS UNCLASSIFIED
DATE 1-10-80 BY 2842 pmv/2mm

This document contains neither recommendations nor conclusions of the FBI. It is the property of the FBI and is loaned to your agency; it and its contents are not to be distributed outside your agency.

100-440423-543

ENCLOSURE

b6
b7c

Gregory states opinion on today's issues

By SYLVIA KRONSTADT

"I don't know how I can stand here with a straight face and say it's a pleasure to be in Salt Lake City."

With warmth, anger and eloquence, Black comedian Dick Gregory addressed an audience of an estimated 4000 Monday night in the Special Events Center as part of Challenge Week. Following an introduction by Black Student leader Bill Bey, Mr. Gregory launched into a 2 hour presentation that was often humorous, often poignant; cynical, personal and powerful. Equally harsh and equally affectionate with the Brothers as with the predominantly white audience, Mr. Gregory probed a vast range of issues including education, law and order, religion, national priorities and ghetto existence. "Committed and dedicated to nonviolence," Mr. Gregory preached human rights, common sense and morality. "You have a big job — the job of giving America back its sanity," he said.

ON MORALITY: "You kids seem to think that morality is a Brooks Brothers suit, a shave and a haircut once a week. . . . Stay morally pure, morally honest. Rally behind morality — that's the one bomb America can't cope with."

ON RELIGION: "If you admit that one of the sons of Adam and Eve was black, what does that say about Adam and Eve, and all of you? . . . You can have any kind of belief you want, but not at my expense. I am glad that the black's attack on the Mormon Church has remained at the institutional level; the day black folks start stooping to the petty level of attacking the individual Mormon, I'll side with the Mormon."

ON THE BLACK POWER SALUTE: "They all say, 'What does that mean?' Haven't you ever seen a box of baking soda?"

ON THE CHICAGO 7 CONTEMPT RULINGS: "In a free and democratic society, the law

can't sit by and watch violations add-up and then arrest you for the sum total, unless it has some intention other than upholding the law."

GENERATION GAP: "Twenty-four hours a day the System lies to you. Then when you catch it, they call it the generation gap."

ON THE POLICE: "You can't blame the police. They're controlled by the same people that pollute the air and the water and enforce poverty with low wages."

ON TEACHERS: "American teachers have closed down every school in the country, striking to increase their salaries — but when Nixon vetoed the education bill, you didn't hear a word from them. That wasn't their money; that would have gone to the kids."

ON ADULTS: "Most of them are so busy making money, they haven't had a moral thought run through their heads in 40 years."

ON BUSSING: "Don't ask me about bussing. You've been bussing black kids past white schools and white kids past black schools for years to enforce an immoral situation — and now you wonder if it's proper to do it to create a moral situation."

"The tragedy of the Mississippi thing is those white parents keeping their 7-year-old kids out of school. The white kids will pay the price. It's sad; it's not funny, at all."

ON CONSERVATISM: "That flag is not going to hide your insane degeneracy. . . . Since bigotry is no longer fashionable, people try to hide it under conservatism."

"The first patriots were always on the side of the oppressed. You so-called patriots today are on the side of the oppressor."

ON RACISM: "Individual racism is legal — it's constitutionally protected freedom of expression. But it is institutional racism that keeps black people down. Most black folks don't hate white folks — we hate your vicious, insane

(Continued on page 7)

(Continued from page-1)

white racist institutions."

ON LANGUAGE: "Angel food cake is always white. Devils food cake is always black. A little lie is a white lie. A tornado is black till it comes inside to clean up the lady's kitchen. Then, it's a white tornado."

ON THE CITIES: "We damn near own the country now. You gave us all the major cities without a fight. Did you say Washington, D.C. is your capital?"

ON THE WHITE MAN: "The white man in this country is the sickest man in the world."

ON YOUNG PEOPLE: "Thank you for turning the civil rights movement into a human rights movement. . . . You are the most morally dedicated group of young folks in the history of this country. . . . You have to solve problems you had no part in creating — problems that were here before you were born. Not only did we not solve the problems, but for the first time in history, we've used up all the tricks."

ON NIXON: "Dick Nixon shows you the state of this nation better than anything I could do tonight. When he had to pick a model of equity, honesty and courage out

of 200 million people, he chose Haynesworth. The second time around, he reached even further down into the barrel of scum."

ON THE PROPERTY FETISH: "When those buildings blew up in New York, it was at night; nobody was there, nobody was hurt. Now they're talking about the death penalty for possession of dynamite. What about heroin pushers? That's just human life that's involved, but since it's not property they're not so concerned."

ON DRUGS: "Dope couldn't come into this country without the consent of the politicians and the police . . . all drugs and artificial stimulants are bad, including coffee, tea and alcohol."

ON JUSTICE: "The policemen in Harlem shake hands with the pimps and the pushers. But when beautiful black people, like Stokely or H. Rap come into the ghetto, not to sell heroin or a woman's ass, but to uplift my people, then the police get up-tight."

ON RELEVANT EDUCATION: "After watching whores turn tricks when I was 5 years old, learning to read about Dick and Jane up on the hill didn't interest me at all, when I was 6."

ON NONVIOLENCE: "You're the ones that pin a medal on him for killing a whole batallion of Viet Cong. . . . If you think you can draft a black man, send him to Fort Collins to learn how to be a "gorilla," ship him to Vietnam to kill one foreigner to free another foreigner — and then think he's going to come back here and not kill you to free his mother — you're crazy."

FEDERAL BUREAU OF INVESTIGATION

Date 4/3/70

At approximately 8:00 p.m., at the Sports and Special Events Arena, University of Utah, Salt Lake City, Utah, DICK GREGORY began his speech to a crowd of approximately 2,500 individuals. GREGORY was conservatively dressed in a charcoal grey suit and light tie. GREGORY began his speech by stating how unhappy he was in being in Salt Lake City and how he would have preferred to be somewhere else. He stated he did not want to be condemned for his speech as JERRY RUBIN had been for his and specifically brought out the fact that he, DICK GREGORY, was not responsible for RUBIN's ideas or actions. As a result of RUBIN's speech, GREGORY advised that he had been telephonically contacted and advised not to curse or use profanity of any kind in his speech.

GREGORY advised that he was "here to set the youngsters of today straight" as they could not expect to get the true story of the events occurring today from what was printed in the newspapers.

GREGORY stated that the biggest Black Power incident in recent years was the naming of a hurricane, BEULAH. He referred to the white overtones which appear on television today, especially in commercials. He said that instead of seeing "the white dove fly into a white woman's white kitchen," he would much rather see "a black crow fly into his Mamã's kitchen and land on some of her biscuits." He further stated the only time a black cowboy gets to kill a white cowboy is when "the white cowboy has just raped a blind paraplegic who is working for the Salvation Army."

He stated that the youth of today have problems to solve which they themselves did not create but for which the "old fools of today" are responsible.

In reference to the White, Southern educated children, GREGORY stated they are illiterate because of the bigotry of their white parents. These parents would rather see their children not go to school at all then go to school with Black children.

On 3/30/70 at Salt Lake City, Utah File # Salt Lake City 157-110

by SA mjj Date dictated 3/31/70

b6
b7c

In regards to the bussing problem, GREGORY said that since "DICK NIXON" has lessened attempts to integrate schools, "we, the Blacks, have been responsible for more integration in the last two months than has occurred in the last fifteen years.

GREGORY then referred to "DICK NIXON's" recent selections for Justices of the Supreme Court. He said that NIXON had to dig down deep in the barrel to come up with HAINSWORTH and had to dig even deeper in the "scum" to come up with a man like CARSWELL.

He stated that NIXON's speeches on Vietnam have been addressed to old people when, in fact, they should be addressed to the young of America. GREGORY stated that anyone who follows NIXON's commitment in Vietnam had to be crazy, "only fools back NIXON's policy in Vietnam." In reference to NIXON's request to have people turn their headlights on in support of his Vietnam policy, GREGORY stated that the only thing it did was to sell car batteries.

In reference to patriots, GREGORY stated that in the past "patriots were on the side of the oppressed, whereas today, patriots are on the side of the oppressors."

Regarding air pollution, GREGORY stated that today, instead of seeing GEORGE WASHINGTON and others standing behind a flag, one would be more likely to see the flag flapping in the breeze on the top of a large corporation building behind which could be seen clouds of black smoke polluting the air.

GREGORY then made reference to the fact that only the poor are fighting and dying in Vietnam. He asked where were the FORDs, ROCKEFELLERS, and DUPONTs, in Vietnam. He stated that DEAN RUSK's son has been out of school for 6 years and has not been in the Army yet. GREGORY stated he only wished he was younger so that he could receive an induction notice. He would then immediately fly to Washington, D. C., where he would handcuff himself to RUSK's son and go on nationwide television stating, "whatever is wrong with him is also wrong with me."

He then made reference to the appearance of DICK NIXON's son-in-law, DAVID EISENHOWER, on the cover of a

nationally circularized magazine being sworn into the Naval Reserves. GREGORY stated that it was just as easy being in the Boy Scouts as it was to be in the Naval Reserves.

GREGORY then said that when the Governor of the State of Mississippi gives a racist speech, the same speech can be given by the Governor of the State of California or the State of Illinois and it would be considered conservative. GREGORY stated that when he, himself, goes to the State of Mississippi and gives a speech, they say he is Black Power inspired; however, when he gives the same speech in Chicago, Illinois, he is said to have stirred up the white backlash.

GREGORY then expounded on how the whites are the corrupters of words, not the Blacks. He said that whites call all evil Black and all good white. He stated that white people get upset about the term, "Black Power," but if the term "Brown Strength" would have been used, think of the greetings the Blacks would have received from the whites, "Brown Strength, Brother, Brown Strength."

GREGORY stated that if he had been working in the Ford Factory plant ten years ago and a white man called him "nigger" he would have socked him and would have been fired on the spot. However, the white man would think twice before firing him today because he would probably burn the plant down.

He then stated that there is a depression coming and that NIXON is the cause of it. He stated the Blacks will not be hurt like the white people because the blacks have not invested in Wall Street as have the whites to make money, their chief and only occupation. GREGORY then went on to say that NIXON will not last more than four years in the White House because peoples' pocketbooks will be empty and the silent majority who voted him in will become the vocal majority who will vote him out.

GREGORY then made reference to NIXON's recent stand on bombers and the tightening up of bombing laws. He asked why is the death penalty not given for heroin pushers as well. He again asked why has there been no public outcry against the recent robbery in the State of Connecticut when almost a whole town was blown up during

SU 157-110

4

the day, just minutes before a rush hour crowd would have been killed as a result of the ruse used by the robbers to throw off suspicion from themselves enabling them to rob the bank. GREGORY, however, could not understand why there was such a public outcry when three buildings in New York City were blown up, when it was at night, with no danger to human life, and no value of property destroyed, so to speak.

GREGORY answered the above questions by stating that a large monetary profit, even if obtained criminally, is condoned by people today; however, when no money is involved, people shutter when force is used.

He stated the reason the death penalty is not given for heroin pushers is that there is too much money to be made in the selling of heroin. He asked why is it that he, DICK GREGORY, could come to Salt Lake City, Utah, at 9:15 p.m., and by 9:30 p.m. have made a contact to purchase heroin, and by 9:45 p.m., have it shooting through his veins, while the local police, who have been born in Salt Lake City and lived here all their lives, cannot find these same people. He then asked why did the whites not listen to the Blacks when they cried out against the white pushers selling heroin to their children in Harlem. He said these same whites who were deaf to the Black cries are now crying out because the Black pushers are selling heroin to the whites' children. He pointed out the fact that according to the Federal Bureau of Narcotics and Dangerous drugs, in the past five years, there has been a 42 percent drop in the use of drugs by Negroes, which accomplishment they did themselves with no help from the whites; however, the use of drugs by whites is continually rising.

GREGORY stated that "DICK NIXON" is dumb and stupid and is the most stupid president this country has ever had. He referred to NIXON as the last "trick," meaning in effect that the election of NIXON is the last act that old people could pull off on the younger generation.

GREGORY was pleased to state that the whites have given the Blacks almost all of the major cities, including their capital, without a fight. He compared this to HILTER giving Berlin to the Jews.

GREGORY questioned how DICK NIXON could be so dumb as to ask for billions of dollars for the ABM System and yet veto the Aid for Education bill. He stated that when NIXON had vetoed the bill, teachers throughout the country should have struck and closed all of the schools in the country. His main concern over this veto was that the money was "for the children, not for the teachers."

He then questioned why the college students were so apathetic. He cited the postal strike across the nation as an example. He could not understand why the students did not get behind the postal employees to fight for their rights, which workers, according to GREGORY, would have rallied behind the youth if such action had been taken. He went on to say that if the youth had gotten behind the postal employees, then may be the cops would have dropped their guns in order to strike for a decent wage instead of striking out against the working class. The cops, GREGORY stated, should strike out against the rich industrialists who are the ones preventing them from obtaining a decent wage, not against the poor, harding-working class who have no control over the salary the cops receive.

GREGORY then made reference to the Chicago "7" trial. He compared Judge HOFFMAN to ADOLF HILTER. He stated that all of the old fools of the nation advised that the Chicago "7" and all radicals should be thrown in jail; however, it is the old drunken fool who kills more people in automobiles, pads more expense accounts, and cheats more on his income tax and is the first to shout against law and order. GREGORY cited HOFFMAN's illegal means used to hand down contempt sentences. Instead of HOFFMAN handing down sentences as they occurred, he waited until the end of the trial. According to GREGORY, the contempt citations were handed down at the end of the trial to fulfill HOFFMAN's scheme to jail the defendants, denying them of their rights if need be.

GREGORY stated the reason BOBBY SEALE was bound and shackled was not because of the language which he used, as the language used by the other defendants was much worse than SEALE's, but because at the trial BOBBY SEALE had asked Judge HOFFMAN how much stock he owed in the Brunswick Corpora-

SU 157-110

6

tion, which corporation is one of the largest manufacturers of armaments in the country. SEALE was denied the right to act as his own defense counsel; however, GREGORY pointed out that whites like JACK RUBY and CHARLES MANSON, the individual accused of killing SHARON TATE and others in the State of California, were not denied this right because they were white.

GREGORY laughed at how the white people today are now saying that Black people should not start the practice of genocide when the whites, in fact, have been practicing it for years regarding the American Indian. GREGORY stated that America cannot call herself a democracy until she takes steps to rectify herself with the American Indian.

GREGORY then talked about Operation Intercept, an attempt by the Government to tie up all of the marijuana in the country. He questioned why was there not an attempt to stop the sale of heroin instead of marijuana. He stated there is absolutely no heat put on the heroin pushers at all. If the program is successful, according to GREGORY, all that will be accomplished is that the kids will move on from marijuana to heroin.

In reference to Prime Minister POMPIDOU of France, GREGORY asked why NIXON had not criticized him for allowing heroin to be processed in France and its free passage from France to Canada where it eventually filters into the United States.

GREGORY stated that the CIA and the FBI are not about to let any outside force come in and overthrow the government because they are so "dirty" that they will take it over first.

GREGORY stated that the Black Panther Party members are being killed by the same individuals who will kill Law and Order by allowing the Stop and Frisk bill and the No Knock Narcotics bill to become law. Yet cops who bring down an SDS demonstration would not dare to arrest a drug pusher.

GREGORY stated that the Blacks do not hate white people themselves, but hate their racist institutions. He

said he was not against white individuals as such but against the racism which is created through large industrial and political institutions.

GREGORY could not understand why cops come in and drive out such beautiful Blacks as CARMICHAEL, RAP BROWN, and members of the Panthers when their only purpose is to uplift the Blacks in the ghetto.

GREGORY said he was tired of the Mormon Church. He said that individual Mormons are not responsible for its actions but the Church's hierarchy was. He stated that if the Supreme Court could make such a drastic change in the integration laws in 1954, then the Mormon Church could do the same. He stated that the white man had raped his mother, his grandmother, and his greatgrandmother and that that makes him white enough to become a bishop of the Church. He stated that they were just about through with their research on the Mormon Church and that they were going to deal with the Church this summer. He went on to name some of the business operations which the Church controlled, such as Harman's Kentucky Fried Chicken, the Coke-a-Cola Company and Safeway Stores, Incorporated.

GREGORY stated that when the riot season opened this season, the old fools should watch the events happening on television and listen while he read the Declaration of Independence simultaneously and perhaps they would be able to see why it is happening.

GREGORY stated that how could a violent country teach the Blacks violence and killing and not expect the Blacks to turn around and use this skill to free themselves. GREGORY stated he believes in nonviolence but will not preach it and is willing to die before he is willing to kill another individual.

GREGORY stated that the biggest hangup white people have today is they think all Black men want are white women. He said if this is truly the case, then it is the white man's fault because all a Black boy sees today is a body of a white woman smeared all over the magazines, ads, and television.

SU 157-110

8

GREGORY stated that white people say that the Black woman is strong. However, according to GREGORY, the black man is strong while the Black woman is responsible.

GREGORY stated that the Civil Rights movement in this country has been changed to the Human Rights movement, and that morality is needed to shove into this establishment.

GREGORY concluded his speech at approximately 10:30 p.m.

FBI

Date: 4/16/70

WCS/ST

Transmit the following in _____
(Type in plaintext or code)

Via AIRTEL _____
(Priority)

TO: DIRECTOR, FBI
FROM: SAC, LAS VEGAS (157-582) (RM)
SUBJECT: DICK GREGORY
RM



Enclosed herewith for the Bureau are five copies of LHM dated and captioned as above.

Confidential source utilized in the LHM is



b6
b7C
b7D

1 cc at
Copy to S5, IDZU, FSD
by routing slip for
 info action.
date 4/20/70
by Coffman

- ② - Bureau (Enc. 5) (RM)
 - 1 - Las Vegas
- RHP:jsb
(3)

ENCLOSURE

EX-115

REC-29

100-1-1423 544



RACIAL INT. SECT.

Approved: 372
58 MAY 5 1970 Special Agent in Charge

Sent _____ M Per _____

H9/ox



UNITED STATES DEPARTMENT OF JUSTICE
FEDERAL BUREAU OF INVESTIGATION

In Reply, Please Refer to
File No.

Las Vegas, Nevada

April 16, 1970.

DICK GREGORY
RACIAL MATTERS

On April 14, 1970, a confidential source who has furnished reliable information in the past advised that Dick Gregory, a former comedian, lectured on civil rights on April 13, 1970, at the Student Union of the University of Nevada, Las Vegas (UNLV), Las Vegas, Nevada. Gregory was presented as a guest lecturer by the UNLV Faculty Lecture Series and spoke before approximately 400 people. Source advised Gregory said an economic depression is beginning in the country and that Las Vegas will soon feel its effects. Gregory put the blame on President Nixon and predicted he would not be re-elected in 1972. He stated the problem in America today is not one of black and white, but one of attitude. He advised "If you think the Black Panthers are being killed because they are black or carrying guns you are a fool. They're being annihilated because they are feeding the hungry." Gregory further stated that the Government survives by keeping 44 million Americans hungry, and that nothing promotes thinking as fast as a full stomach. He added his support for a nationwide boycott, which he stated may take place this fall. The boycott, as Gregory explained it, will involve almost every commodity except the most necessary things.

This document contains neither recommendations nor conclusions of the FBI. It is the property of the FBI and is loaned to your agency; it and its contents are not to be distributed outside your agency.

10-9-440423-544

- 1* -

ENCLOSURE

UNITED STATES GOVERNMENT

Memorandum

TO: *LEC* DIRECTOR, FBI (100-440423)

DATE: 4/22/70

FROM: SAC, ALBANY (157-253) (RUC)

SUBJECT: RICHARD CLAXTON GREGORY, aka
Dick Gregory
(AGITATOR INDEX)
RM

(OO: CHICAGO)

Re Albany airtel to Bureau, 4/8/70.

Enclosed for the Bureau are eight copies and two copies for Chicago of an LHM reflecting the results of the appearance of the subject at Burlington, Vt., on 4/12/70. A copy of this LHM has been furnished to 108th MIG, Burlington, Vt., and Secret Service, Boston, Mass.

- 2- Bureau (Encs. 8) (RM)
- 2- Chicago (Encs. 2) (RM) (157-347)
- 1- Albany
- AOA:dap
- (5)

*1 - destroyed
1 - 8/4/0*

ALL INFORMATION CONTAINED
HEREIN IS UNCLASSIFIED
DATE 1-10-80 BY 2842 pmv/kebm

REC-35

100-440423-345

AGENCY: ACSI, ~~OSI~~, OSI, SEC. SERV.,
DEPT: ISD, ~~OSI~~, IDIU, ~~(157-253)~~
HOW FORW: 1/5
DATE FORW: 4/30/70
BY: [Signature]

APR 24 1970

RACIAL INT. SECT.

59 APR 30 1970





UNITED STATES DEPARTMENT OF JUSTICE

FEDERAL BUREAU OF INVESTIGATION

Albany, New York

April 22, 1970

In Reply, Please Refer to
File No.

RICHARD CLAXTON GREGORY,
also known as Dick Gregory

[redacted] University of Vermont, advised on April 13, 1970, that RICHARD CLAXTON GREGORY arrived in Burlington, Vermont, from Connecticut, at 7:15 PM on April 12, 1970, and appeared at the University of Vermont, at 8:15 PM, at which time he delivered a lecture pertaining to his background in show business.

b6
b7c

[redacted] advised that the tone of the lecture was very moderate, in that GREGORY repeatedly stated that he felt that the statements identifying police officers as "pigs" was uncalled for and that he does not believe in the violence that has been attributed to various racial organizations. He further stated that he does not believe in violence by any group agitating for change and specifically identified the organization Students for a Democratic Society as one that he does not respect.

GREGORY remained at Burlington the evening of April 12, 1970, and departed the morning of April 13, 1970, destination unknown.

This document contains neither recommendations nor conclusions of the FBI. It is the property of the FBI and is loaned to your agency; it and its contents are not to be distributed outside your agency.

ALL INFORMATION CONTAINED
HEREIN IS UNCLASSIFIED
DATE 1-10-80 BY 2842 pmv/jcm

ENCLOSURE

100-440423-545

STUDENTS FOR A DEMOCRATIC SOCIETY

A source has advised that the Students for a Democratic Society (SDS), as presently regarded, came into being at a founding convention held June, 1962, at Port Huron, Michigan. From an initial posture of "participatory democracy" the line of the national leadership has revealed a growing Marxist-Leninist adherence which currently calls for the building of a revolutionary youth movement. Concurrently, the program of SDS has evolved from civil rights struggles to an anti-Vietnam stance to an advocacy of a militant anti-imperialist position. China, Vietnam and Cuba are regarded as the leaders of worldwide struggles against the United States imperialism whereas the Soviet Union is held to be revisionist and also imperialist.

At the June, 1969 SDS National Convention, Progressive Labor Party (PLP) forces in the organization were expelled. As a result, the National Office (NO) group maintained its National Headquarters at 1608 West Madison Street, Chicago, and the PLP faction set up headquarters in Cambridge, Massachusetts. This headquarters subsequently moved to Boston. Each group elected its own national officers, which included three national secretaries and a National Interim Committee of eight. Both the NO forces and the PLP forces claim to be the true SDS. Both groups also print their versions of "New Left Notes", which sets forth the line and the program of the particular faction. The NO version of "New Left Notes" was recently printed under the title "The Fire Next Time" to achieve a broader mass appeal.

Two major factions have developed internally within the NO group, namely, the Weatherman or Revolutionary Youth Movement (RYM) I faction, and the RYM II faction. Weatherman is action-oriented upholding Castro's position that the duty of revolutionaries is to make revolution. Weatherman is regarded by RYM II as an adventuristic, elitist faction which denies the historical role of the working class as the base of revolution. RYM II maintains that revolution, although desired, is not possible under present conditions, hence, emphasizes organizing and raising the political consciousness of the working class

2.

upon whom they feel successful revolution depends. Although disclaiming control and domination by the Communist Party, USA, leaders in these two factions have in the past proclaimed themselves to be communists and to follow the precepts of a Marxist-Leninist philosophy, along pro-Chinese communist lines.

A second source has advised that the FLP faction which is more commonly known as the Worker Student Alliance is dominated and controlled by members of the PLP, who are required to identify themselves with the pro-Chinese-Marxist-Leninist philosophy of the FLP. They advocate that an alliance between workers and students is vital to the bringing about of a revolution in the United States.

SDS regions and university and college chapters, although operating under the outlines of the SDS National Constitution, are autonomous in nature and free to carry out independent policy reflective of local conditions. Because of this autonomy internal struggles reflecting the major factional interests of SDS have occurred at the chapter level since the beginning of the 1969-70 school year.

A characterization of the PLP is attached.

1.

APPENDIX

PROGRESSIVE LABOR PARTY (PLP)

"The New York Times" city edition, Tuesday, April 20, 1965, page 27, reported that a new party of "revolutionary socialism" was formally founded on April 18, 1965, under the name of the PLP which had been known as the Progressive Labor Movement.

According to the article, "The Progressive Labor Movement was founded in 1962, by Milton Rosen and Mortimer Scheer after they were expelled from the Communist Party of the United States for assertedly following the Chinese Communist line."

A source advised on June 3, 1968, that the PLP held its Second National Convention in New York City, March 31 to June 2, 1968, at which time the PLP reasserted its objective of the establishment of a militant working class movement based on Marxism-Leninism. This is to be accomplished through the Party's over-all revolutionary strategy of raising the consciousness of the people and helping to provide ideological leadership in the working class struggle for state power.

The source also advised that at the Second National Convention, Milton Rosen was unanimously reelected National Chairman of the PLP and Levi Laub, Fred Jerome, Jared Israel, William Epton, Jacob Rosen, Jeffrey Gordon, and Walter Linder were elected as the National Committee to lead the PLP until the next convention.

The PLP publishes "Progressive Labor" a bimonthly magazine; "World Revolution," a quarterly periodical; and "Challenge-Desafio," a monthly newspaper.

2.

The April, 1969, issue of "Challenge-Desafio" sets forth that "Challenge is dedicated to the peoples fight for a new way of life--where the working men and women control their own homes and factories; where they themselves make up the entire government on every level and control the schools, courts, police and all institutions which are now used to control them."

Source advised on May 8, 1969, that the PLP utilizes an address of General Post Office Box 808, Brooklyn, New York, and also utilizes an office in Room 617, 1 Union Square West, New York, New York.

UNITED STATES GOVERNMENT

Memorandum

TO : DIRECTOR, FBI

DATE: 4/21/70

FROM: SAC SPRINGFIELD (157-189) - P -

SUBJECT: DICK GREGORY APPEARANCE
SPAULDING INSTITUTE
PEORIA, ILLINOIS
April 4, 1970
RM

Re Springfield teletypes to the Bureau 4/2/70 and 4/4/70.

Enclosed for the Bureau are the original and seven copies of a self-explanatory letterhead memorandum suitable for dissemination. Also enclosed for the Bureau are two copies of an FD-376.

This letterhead memorandum has been disseminated locally to USA, Springfield, Illinois; Secret Service, Springfield, Illinois; NISO, Chicago, Illinois; OSI, Chanute Air Force Base, Illinois; and 113th MI Group, Evanston, Illinois.

This letterhead memorandum is being classified confidential since it contains information from sources of continuing value and any unauthorized disclosure might result in harm to national defense interests of the United States.

Source who furnished information in enclosed letterhead memorandum is [redacted] confidential racial source.

Identity of Special Agents mentioned in the letterhead memorandum regarding observation of DICK GREGORY appearance in Peoria, Illinois, on April 4, 1970, are Special Agents [redacted] and [redacted]

Observation of GREGORY was appropriately recorded on an FD-302. Included in this letterhead memorandum is only an excerpt, highlighting GREGORY's comments at the meeting.

Recordings made of GREGORY's speech are being reviewed, and if appropriate, transcription will be made.

- 2 - Bureau (Enc. 10) (RM)
 - 3 - Springfield (2: 157-189) (1: 66-1967)
- JDF:mpb
(5)

ENCLOSURE

REC-66 100-440423-5916

5 destroyed
1-7970

SI-119

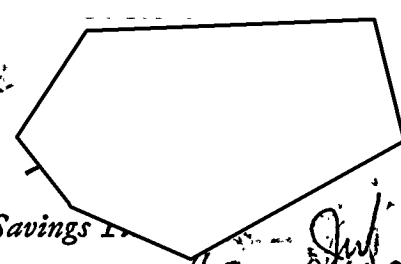

MAY 27 1970

Buy U.S. Savings Bonds Regularly on the Payroll Savings Plan

Consolidation

Copy to ISO, IDIU, by routing slip for info action date 5/16/70 by [redacted]

b6
b7C
b7D

b6
b7C



UNITED STATES DEPARTMENT OF JUSTICE

FEDERAL BUREAU OF INVESTIGATION ~~CONFIDENTIAL~~

In Reply, Please Refer to
File No.

Springfield, Illinois
April 21, 1970

DICK GREGORY APPEARANCE
SPAULDING INSTITUTE GYMNASIUM
PEORIA, ILLINOIS
April 4, 1970

On April 2, 1970, a source who has furnished reliable information in the past, advised that Dick Gregory, Negro anti-establishment comic, is to speak at Spaulding Institute Gymnasium, 409 Northeast Madison Street, Peoria, Illinois, on April 4, 1970, at 7:30 p.m. Gregory's appearance is being sponsored by the Tazewell County Human Relations Committee and is opened to the general public, cost \$1.50 for students, \$3.00 for adults. Gregory is to speak about his book entitled "Nigger," his childhood experiences, and what the people in the Peoria, Illinois, area can do to help better relations between the whites and blacks. He advised that the only props requested were a podium, speaker system and a piano. He advised that he expected no disturbances or demonstrations.

On April 4, 1970, Special Agents of the Springfield Division, Federal Bureau of Investigation, observed Dick Gregory at the Spaulding Institute Gymnasium, Peoria, Illinois.

~~CONFIDENTIAL~~

GROUP 1
Excluded from automatic
downgrading and
declassification

100-440423-546

ENCLOSURE

~~CONFIDENTIAL~~

FEDERAL BUREAU OF INVESTIGATION

Date April 10, 1970

1

Dick Gregory appeared at the Spaulding Institute Gymnasium, 405 Northeast Madison Street, Peoria, Illinois, on April 4, 1970, and spoke from approximately 8:25 p.m. to 10:20 p.m. Gregory spoke for approximately two hours before a mixed crowd consisting of approximately 250 persons, mostly adult couples. Gregory's appearance at Spaulding Institute Gymnasium was sponsored by Tazewell Citizens Committee on Human Relations, a committee dedicated to establishing better relations between whites and blacks as well as achieving equality among races. According to a meeting program, [redacted]

b6
b7c

[redacted] Illinois, resident, is listed as the [redacted]

members of the committee are [redacted]

Illinois resident, and [redacted]

[redacted] ILLINOIS.

GREGORY, who spoke for approximately two hours, stated that he does not believe in violence and characterized the young American people as being the most moral, ethical and dedicated group in the country. He advised that it is the task of America's youth to fully implement the United States Constitution so that everyone in America can be treated equally. He advised that America's youth are not fools and who believe in human rights, and that the fate and destiny of America rests in the hands of the young.

GREGORY praised the Black Panthers' program of feeding the hungry in the nation. He advised that the Black Panthers who were killed in Chicago, Illinois, last year, FRED HAMPTON and MARK CLARK, as well as JOCK YABLONSKI, defeated candidate for the president of the union of Mine Workers, who was shot to death in his home in early 1970, were killed because they were talking about feeding hungry Americans. He advised that hunger is the most important problem in the United States and that approximately 44,000,000 persons in America go to bed at night time hungry.

On 4/4/70 at Peoria, Illinois File # SI 157-189

by SA [redacted] JDF:mpb Date dictated 4/7/70

b6
b7c~~CONFIDENTIAL~~

DICK GREGORY APPEARANCE
SPAULDING INSTITUTE GYMNASIUM
PEORIA, ILLINOIS
April 4, 1970

~~CONFIDENTIAL~~

SI 157-189

2

GREGORY criticized President RICHARD M. NIXON's choice of Federal Judges CLEMENT HAYNSWORTH and HAROLD CARSWELL to the United States Supreme Court. He advised that out of the 200,000,000 people living in the United States, it is hard to believe that the best the President could find was HAYNSWORTH and CARSWELL. He advised that CARSWELL's nomination was not only an insult to the black people but it was also an insult to the decent white people in the United States.

He stated that President NIXON is the "dumbest white boy" the people ever sent to the White House. He advised that President NIXON doesn't even look like he believes he is President of the United States. He advised to show how "dumb, President NIXON is," President NIXON tried to slow down school integration in the South, but that more schools have been integrated in the South in the past two months than in the past four years. He stated, "NIXON is so dumb he called out the Army to move the mail when the postmen went on strike." He advised that it cost more in a month to pay the Army to move the mail than it would have cost to pay the mailmen the raises they desired. He also criticized America's youth for not supporting the mailman's strike.

GREGORY also advised that unemployment is on an upward trend and that America will hit an economic low in the next six months, the lowest in America's history. He advised because of lack of money, top companies in the country will not be recruiting college graduates this year on campus and that aircraft factories are being closed.

GREGORY also criticized Attorney General's JOHN MITCHELL Operation Intercept, an operation used in combatting the influx of marijuana into the United States. GREGORY stated that marijuana is not the real problem in the United States; the problem is heroin. He advised that Operation Intercept is not efficient enough to stop the influx of heroin into the United States. He advised that when narcotics was a problem in the black ghetto areas, nothing was done about it, but now since the narcotic problem is affecting the white community, everyone is concerned.

GREGORY advised that it is not the individual racist who hurts the black man, it is the institutionalized racism that is hurting the black people. He stated the role of the black man in America is quite different from what it was in the past and the black man is tired of playing games. He advised that the white man has been tricking the black man for approximately 400 years, and that the black man is tired of being tricked.

APPENDIX

~~CONFIDENTIAL~~

DICK GREGORY APPEARANCE
SPAULDING INSTITUTE GYMNASIUM
PEORIA, ILLINOIS
April 4, 1970

BLACK PANTHER PARTY
Also Known As
Black Panther Party for Self-Defense

According to its official newspaper, the Black Panther Party (BPP) was started during December, 1966, in Oakland, California, to organize black people so they can take control of the life, politics and the destiny of the black community. It was organized by Bobby Seale, BPP Chairman, and Huey P. Newton, BPP Minister of Defense. Newton was sentenced in 1968 to serve 2 to 15 years after being convicted of manslaughter in connection with the killing of an Oakland police officer.

The official newspaper, "The Black Panther," which further describes itself as the "Black Community News Service," states that the BPP advocates the use of guns and guerrilla tactics in its revolutionary program to end oppression of the black people. Residents of the black community are urged to arm themselves against the police who are consistently referred to in the publication as "pigs" who should be killed.

"The Black Panther" issue of September 7, 1968, contains an editorial by BPP Minister of Education, George Mason Murray, which ends with the following:

"Black men. Black people, colored persons of America, revolt everywhere! Arm yourselves. The only culture worth keeping is a revolutionary culture. Change. Freedom everywhere. Dynamite! Black Power. Use the gun. Kill the pigs everywhere."

Included in the introduction to an article appearing in the October 5, 1968, edition of "The Black Panther" is the statement "...we will not dissent from American Government. We will overthrow it."

Issues of "The Black Panther" regularly contain quotations from the writings of Chairman Mao Tse-tung of the People's Republic of China and feature Mao's statement that "political power grows out of the barrel of a gun."

The national headquarters of the BPP is located at 3106 Shattuck Avenue, Berkeley, California. Branches have been established at various locations throughout the United States.

This document contains neither recommendations nor conclusions of the FBI. It is the property of the FBI and is loaned to your agency; it and its contents are not to be distributed outside your agency.

APPENDIX

~~CONFIDENTIAL~~

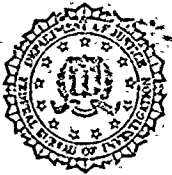

~~CONFIDENTIAL~~

UNITED STATES DEPARTMENT OF JUSTICE
FEDERAL BUREAU OF INVESTIGATION

WASHINGTON, D.C. 20535

In Reply, Please Refer to
File No.

April 21, 1970

Director
United States Secret Service
Department of the Treasury
Washington, D. C. 20220

Dear Sir:

The information furnished herewith concerns an individual who is believed to be covered by the agreement between the FBI and Secret Service concerning Presidential protection, and to fall within the category or categories checked.

1. Has attempted or threatened bodily harm to any government official or employee, including foreign government officials residing in or planning an imminent visit to the U. S., because of his official status.
2. Has attempted or threatened to redress a grievance against any public official by other than legal means.
3. Because of background is potentially dangerous; or has been identified as member or participant in communist movement; or has been under active investigation as member of other group or organization inimical to U. S.
4. U. S. citizens or residents who defect from the U. S. to countries in the Soviet or Chinese Communist blocs and return.
5. Subversives, ultrarightists, racists and fascists who meet one or more of the following criteria:
 - (a) Evidence of emotional instability (including unstable residence and employment record) or irrational or suicidal behavior;
 - (b) Expressions of strong or violent anti-U. S. sentiment;
 - (c) Prior acts (including arrests or convictions) or conduct or statements indicating a propensity for violence and antipathy toward good order and government.
6. Individuals involved in illegal bombing or illegal bomb-making.

Photograph has been furnished enclosed is not available
 may be available through _____

Very truly yours,

J. Edgar Hoover
J. Edgar Hoover
Director

1 - Special Agent in Charge (Enclosure(s))
U. S. Secret Service

~~CONFIDENTIAL~~

Enclosure(s)

(Upon removal of classified enclosures, if any, this transmittal form
becomes UNCLASSIFIED.)

UNITED STATES GOVERNMENT

Memorandum

TO : DIRECTOR, FBI (157-12382)

DATE: 4/29/70

FROM : SAC, TAMPA (157-3163) (RUC)

SUBJECT: RICHARD CLAXTON GREGORY
RM
(OO:CG)

CR
ENCL
2

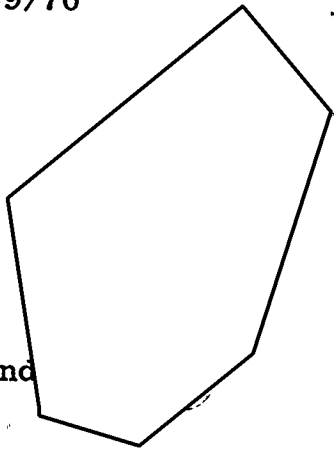

ReTPairtels to Director, 2/13 and 3/25/70.

Enclosed for the Bureau are the original and copies of an LHM and two copies of FD-376.

Enclosed for Chicago are two copies of LHM.

Copies of enclosed LHM are being furnished to Secret Service, JK; MI, Orlando; USA, TP and OSI, Patrick AFB, Fla.

b6
b7C

Tampa Division has active investigation open on [redacted] TP 157-4406, and Black Student Union, Valencia Junior College, TP 157-4451.

ALL INFORMATION CONTAINED
HEREIN IS UNCLASSIFIED
DATE 1-10-80 BY 2842 pmv/etm

REC-112

100-440423-547

MAY 1 1970

5 dashes
1-804

RACIAL INT. SECT.

- 2 - Bureau (Encl 13) (RM)
- 2 - Chicago (157-347) (Encl 2) (RM)
- 4 - Tampa

1 - 80-139; 1-157-4451 (BSU); 1-157-4406 [redacted]

GDW:fw
(8)

AGENCY: ACSI, SEC. SERV. By/FD-376

DEPT: ISD, IDIU

HCW FORM: 4/5

DATE FORW: 5/8/70

BY: [signature]

b6
b7C





UNITED STATES DEPARTMENT OF JUSTICE
FEDERAL BUREAU OF INVESTIGATION

In Reply, Please Refer to
File No.

Tampa, Florida
APR 29 1970

RICHARD CLAXTON GREGORY

On February 13, 1970, Charles Norman Millican, President, Florida Technological University (FTU), Orlando, Florida, advised that Dick Gregory was scheduled for a speaking engagement on April 6, 1970, at the Village Center, FTU.

On March 26, 1970, [redacted]

[redacted] FTU, furnished the following itinerary for Gregory's visit to the Orlando area on April 6, 1970:

Arrive Orlando Jetport aboard Delta Airlines flight 638, 1:42 P. M.; April 6, 1970; press conference, Delta Airlines Conference Room, 2:00 P. M. - 2:45 P. M.; drive to FTU, 2:45 P. M. - 3:15 P. M.; reception, Multi-Purpose Room, FTU, 3:15 P. M. - 4:45 P. M.; drive to Herndon Airport, Orlando, 4:45 P. M. - 5:15 P. M.; dinner - Skyline Restaurant, Herndon Airport, 6:00 P. M. - 7:15 P. M.; return to FTU, 7:15 P. M. - 7:45 P. M.; speech on "Civil Rights" at FTU, 8:00 P. M. - 9:00 P. M.; leave FTU for drive to Orlando Jetport, 9:30 P. M.; depart Orlando for Chicago aboard Delta Airlines flight 176, 10:15 P. M.

b6
b7c

On April 9, 1970, [redacted] advised that Gregory followed the above itinerary while in the Orlando, Florida, area on April 6, 1970, except for the scheduled dinner at Herndon Airport, which he failed to show up for as he was "on a fast". Gregory spoke to a crowd of between 500 and 600 people, approximately one fifth of them Negroes, on the topic "Civil Rights"; however, subjects covered by Gregory

ALL INFORMATION CONTAINED
HEREIN IS UNCLASSIFIED
DATE 1-10-80 BY 2842 PMV/EPom

100-440-423-547

RICHARD CLAXTON GREGORY

in his speech included the news media, education, riots, the Chicago Seven Trial, law enforcement, drugs, Supreme Court nominees, integration and President Nixon. [redacted] stated that Gregory made derogatory remarks concerning President Nixon and other leaders in this country; however, he did not regard Gregory's speech as inflammatory.

[redacted] further advised that [redacted] at FTU, was to have been Gregory's escort during the entire period of his visit to Orlando; however, Gregory between approximately 5:00 P. M. and 8:00 P. M. on April 6, 1970, was not with [redacted] and apparently spent this period of time with [redacted] at FTU.

b6
b7C

FLA

[redacted] on April 13, 1970, furnished a copy of the April 10, 1970, edition of "Future", the official newspaper of FTU. This edition, on pages 1 and 12, contained the following article concerning Gregory's speech entitled "On The Inside With Dick Gregory":

(Mount Clipping in Space Below)

On The Inside With Dick Gregory

"The youth of America will have to solve problems they had nothing to do with creating, that were here before they got here," said Dick Gregory in a speech at FTU April 6. The theme of Gregory's speech was "Civil Rights" and his entire talk was based on the problems of "This degenerate society" and what the youth are up against.

Gregory talked about a number of subjects, those prominent being the news media, the Chicago Seven trial, drugs, democracy, tricks of the adults, the postal strike, law enforcement, the Supreme Court nominees, the "dollar", racism and Viet Nam, women, education, integration and busing, President Nixon, riots, and politics.

His speech was sparked by a great deal of spontaneous laughter and applause from the approximately 500 students and faculty members in the audience.

Gregory was introduced by Chris Schmidt, general station manager of WFTU, and approached the stage greeting the audience with the sign of peace. A banquet at the Herndon

Skyline had been scheduled in his honor but he was unable to attend due to a special juice diet he is on. Upon his arrival at the FTU campus, he jogged a five mile course that had been laid out by Security, as part of his daily routine.

Gregory was vocal and forceful on his subjects. A number of his thoughts were as follows:

On the news media: Kids are important to society. Newspapers aren't responsible in their portrayal of the youth...The same press that blew up over Agnew's speech on media coverage of news has decided guilt in the recent blowing up of buildings. It is very very sick when in a free society the press decides on the guilt of something before

(Continued on Page 12)

(Indicate page, name of newspaper, city and state.)

PAGE 1
FUTURE
Orlando, Florida

Date: 4-10-70

Edition:

Author:

Editor: Linda Mettel

Title:

Character:

or

Classification:

Submitting Office: Tampa

Being Investigated

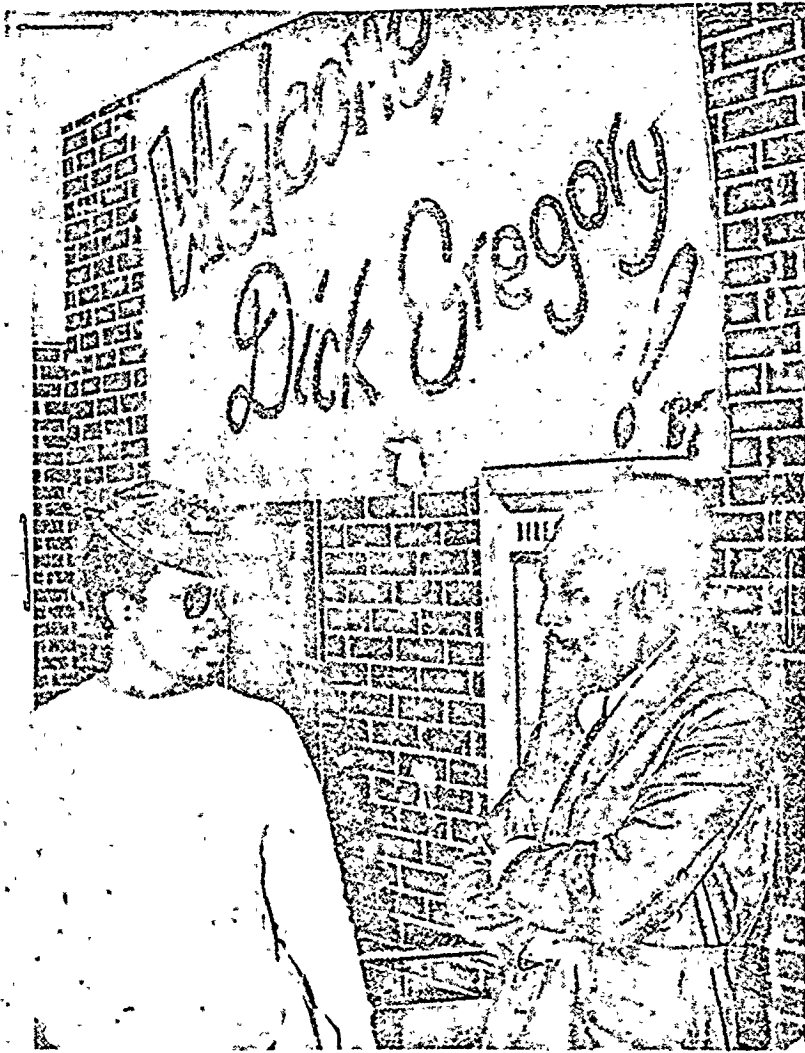

CIVIL Rights commentatör and comedian Dick Gregory turns serious for a brief rap session with FTU Black Student Union President Dan Slater. Gregory spoke to 600 students and faculty Monday evening. (See Story).

the law enforcement officers do.

On the Chicago Seven Trial: When the jury went to deliberate Judge Hoffman sent everyone to jail. The process of law followed here is not the process that is followed in a free democratic society. It is very important that you understand the Chicago Trial. This is the country that made sure all Nazi war criminals got a fair trial.

On drugs: The Syndicate started pushing dope to black kids and the blacks begged the whites to stop them. It wasn't too long before they started pushing it to white kids. The users of drugs are criticized more than the pushers because the pushers make the money.

The Federal government knows every dope pusher in America. If they know every espionage agent, you know they know the dope pushers. They also know where the dope comes from. Without cops and politicians looking the other way, there would be no dope here.

On Democracy: If democracy is as good as they say it is, why are we running around the world ramming it down people's throats with a gun? If something is good, people steal it.

On tricks of the adults: We've used up all the tricks. Getting Nixon into the White House was the last trick this country has.

On the postal strike: It would have cost more money to get the army to deliver mail for three months than it would for the postal workers to get their raise for the rest of their lives.

This is the only country in the world where the college kids don't back the workers. College students should have rallied behind the postmen.

On law enforcement: If you toss dynamite in defense of getting some money, it's all right...The policeman is the number two man in the country...When a man is placed in a responsible position

with little money he will rebel and takes it out on the poor people.

On the Supreme Court nominees: close down every school in the nation.

President Nixon had to pick one person out of 200 million for the SC and he picked Haynesworth saying: "He's the most honest man I know!" Nixon ain't lying! Then he reached further into the barrel of scum and picked Carswell.

On the dollar: It's a sick, degenerate nation that doesn't give a damn about anything but that dollar.

On racism and Viet Nam: I'm not worried about your racism today. I'm worried about your insanity. If I got killed in Viet Nam and my mother got \$10,000 she couldn't buy a house in any neighborhood she wanted in this country. We'll deal with your insanities.



Dick Gregory

On women: Men have to see to it that women in America become first class citizens. All women should be looked at as humans first and women second.

On education: One day school teachers should be one of the highest paid professions in the United States. Not now. The teachers will strike and close the schools when it's their own dollar, but when Nixon cuts the education budget, which is the kid's money,

that is when they should strike and close down every school in the nation.

On integration and busing: Who are the white people going to hurt if they refuse to let their kids go to school?...Black folks have been busing kids past white schools for 50 years to promote segregation, so why do white folks think they have to come up with something new when they introduce busing to promote integration?

On President Nixon: The same people who voted Nixon in will vote him out. He said he was going to shave the budget and he gave more money to the ABM and vetoed the education bill...

Nixon is the dumbest white boy you white folks have put in the White House in the history of this country. If you put Nixons in all the governorships of all the states, the blacks would take over the country in a month.

On riots and the Declaration of Independence: Everyone should go to the library and copy down the Declaration of Independence. When people are burning down cities, they should be read the Declaration so they can see what they are destroying. When rights are destroyed, it is your duty to abolish the system. The Declaration should say 'for whites only'.

On politics: The South has produced some of the lowest politicians in the history of man...they play around with the kids. The North has produced some of the slickest, slimiest politicians...they steal money from the missile program...It takes no money to be a bigot but it takes a lot of money to be a conservative...In six months there will be a low economy unparalleled in the history of America.

In concluding his speech, Gregory addressed the audience and youth in general saying, "Thank you for changing our civil rights movement into a human rights movement."

According to Ken Lawson, Director of the Village Center, "most people think that Gregory was, by far, the best speaker we've ever had on campus. If he didn't do anything else, he made you think."

RICHARD CLAYTON GREGORY

This document contains neither recommendations nor conclusions of the FBI. It is the property of the FBI and is loaned to your agency; it and its contents are not to be distributed outside your agency.



UNITED STATES DEPARTMENT OF JUSTICE
FEDERAL BUREAU OF INVESTIGATION

WASHINGTON, D.C. 20535

April 29, 1970

In Reply, Please Refer to
File No.

Director
United States Secret Service
Department of the Treasury
Washington, D. C. 20220

RE: RICHARD CLAXTON GREGORY

Dear Sir:

The information furnished herewith concerns an individual who is believed to be covered by the agreement between the FBI and Secret Service concerning Presidential protection, and to fall within the category or categories checked.

1. Has attempted or threatened bodily harm to any government official or employee, including foreign government officials residing in or planning an imminent visit to the U. S., because of his official status.
2. Has attempted or threatened to redress a grievance against any public official by other than legal means.
3. Because of background is potentially dangerous; or has been identified as member or participant in communist movement; or has been under active investigation as member of other group or organization inimical to U. S.
4. U. S. citizens or residents who defect from the U. S. to countries in the Soviet or Chinese Communist blocs and return.
5. Subversives, ultrarightists, racists and fascists who meet one or more of the following criteria:
 - (a) Evidence of emotional instability (including unstable residence and employment record) or irrational or suicidal behavior;
 - (b) Expressions of strong or violent anti-U. S. sentiment;
 - (c) Prior acts (including arrests or convictions) or conduct or statements indicating a propensity for violence and antipathy toward good order and government.
6. Individuals involved in illegal bombing or illegal bomb-making.

Photograph has been furnished enclosed is not available
 may be available through _____

Very truly yours,

J. Edgar Hoover
John Edgar Hoover
Director

1 - Special Agent in Charge (Enclosure(s))
U. S. Secret Service, Jacksonville (RM)

Enclosure(s)

(Upon removal of classified enclosures, if any, this transmittal form
becomes UNCLASSIFIED.)

UNITED STATES GOVERNMENT

Memorandum

TO : DIRECTOR, FBI (100-440423)

DATE: 4/30/70

FROM : SAC, MINNEAPOLIS (157-386) (RUC)

SUBJECT: RICHARD CLAXTON GREGORY, aka.
RM

OO: Chicago

Enclosed for the Bureau are eight copies of an LHM concerning GREGORY's appearance in the Minneapolis Division at Yankton, South Dakota.

Enclosed for Chicago are two copies of the above-described LHM.

The source for information in the LHM is

[Redacted]

[Redacted] South Dakota, who obtained information from

[Redacted]

at Yankton College.

respectively, b6
b7C
b7D

- 2 - Bureau (Enc. - 8)
 - 2 - Chicago (Enc. - 2) (RM)
 - 1 - Minneapolis
- SJB:jwh
(5)

ENCLOSURE

REC-35

440423-548

MAY 4 1970

AGENCY: ACSI, ~~SEC.~~ SEC. SERV.,
DEPT: ~~ISS.~~ IDIU

HOW FORM: 8/5

DATE FORW: 5/2/70

BY: [Signature]

1-10-80
2842 pmv ksbm

[Signature]



UNITED STATES DEPARTMENT OF JUSTICE

FEDERAL BUREAU OF INVESTIGATION

In Reply, Please Refer to
File No.

Minneapolis, Minnesota

April 30, 1970

RICHARD CLAXTON GREGORY

The Thursday, April 16, 1970, issue of the "Yankton Daily Press and Dakotan," a newspaper of general circulation published at Yankton, South Dakota, indicated that Richard Claxton Gregory spoke at the Yankton College Forbes Hall, Yankton, South Dakota, on April 15, 1970, as a guest speaker for the Yankton College "Program on World Understanding."

During the two and a half hours that he was on the stage, he covered subjects ranging from education to the Vietnam war and Indian reservations. To the young people in the audience, he said, "You have to solve problems you had nothing to do with creating - thanks to us old fools."

He stated, "Nixon is not president, but after his election on a 'law and order' campaign he is a sheriff and not a very ethical sheriff at that."

"White folks is trying to hide bigotry behind conservatism. Gregory added, saying Nixon was elected by voters who never before voted Republican. But this will return to them," he said, "because white folks in America don't have enough money to last four years, under a Nixon administration that he said has already begun a hard recession.

"You young kids," he said, "you ain't seen no hell raised. Wait 'til your folks find out Nixon's taking their beer money."

Gregory said black people might tend to feel many deaths among the Black Panthers is genocide. But, he said, "They ain't nothing like you dirty stinking people in this state do to the Indians."

100-440423-548

ENCLOSURE

RICHARD CLAXTON GREGORY

He said, "Without police and politicians turning their backs, dope couldn't flourish in this country."

"If democracy is as good as we tell you it is," he said, "why do we have to go all over the world trying to ram it down everybody's throats?....If you have something good, they'll steal it. If you're so afraid of world-wide communism," said Gregory, "prove it.... and not with bombs.... Why don't you use the greatest weapon you have, why don't you implement and utilize the United States Constitution to its fullest?"

A source who has furnished reliable information in the past advised that Gregory's speech at Yankton College was attended by about five hundred students, and that Gregory was paid \$1,000 for his appearance by the Yankton College.

This document contains neither recommendations nor conclusions of the FBI. It is the property of the FBI and is loaned to your agency; it and its contents are not to be distributed outside your agency.

GSA FPMR (41 CFR) 101-11.6

UNITED STATES GOVERNMENT

Memorandum

TO : DIRECTOR, FBI (100-440423)

DATE: 5/1/70

FROM : SAC, KNOXVILLE (157-1523) (RUC)

SUBJECT: RICHARD CLAXTON GREGORY
RACIAL MATTERS

Re Knoxville airtel dated 4/7/70.

Enclosed to the Bureau are 11 copies and Chicago two copies letterhead memorandum regarding captioned matter. Also enclosed for the Bureau are two copies FD-376.

Copies have been disseminated locally to intelligence agencies, Secret Service, Nashville, and U. S. Attorney, Knoxville.

Source referred to in LHM is [redacted]

b6
b7C
b7D

Source advised [redacted] when GREGORY arrived at the airport; however, his talk coincided with the premiere in Knoxville of the movie "A Walk in the Spring Rain."

[redacted] and source indicated that [redacted]

[redacted] source further advised that GREGORY indicated he was on a tight speaking schedule and had to depart Knoxville in order to go to Rochester, New York.

This letterhead memorandum is classified confidential as information contained therein could reasonably result in the identification of a confidential informant of continuing value and compromise future effectiveness thereof.

ALL INFORMATION CONTAINED
HEREIN IS UNCLASSIFIED
DATE 1-10-80 BY pmv 2882/58m

- 2 - Bureau (Enc. 13) (RM)
- 2 - Chicago (157-347) (Enc. 2) (RM)
- 3 - Knoxville (1 - 157-1523)
(1 - 157-1535) (UT File)

REC-6 100-440423-549
MAY 4 1970

AGENCY: ACS, [redacted]
DEPT: ISD, [redacted], IDIU, [redacted]

HAM/pjw
(7)
HOW FORW: [redacted]
DATE FORW: 5/16/70
BY: [redacted]

RACIAL MATTERS
[redacted]

b6
b7C



MAY 19 1970

Buy U.S. Savings Bonds Regularly on the Payroll Savings Plan



UNITED STATES DEPARTMENT OF JUSTICE
FEDERAL BUREAU OF INVESTIGATION

WASHINGTON, D.C. 20535

May 1, 1970

In Reply, Please Refer to
File No.

Director
United States Secret Service
Department of the Treasury
Washington, D. C. 20220

Dear Sir:

The information furnished herewith concerns an individual who is believed to be covered by the agreement between the FBI and Secret Service concerning Presidential protection, and to fall within the category or categories checked.

1. Has attempted or threatened bodily harm to any government official or employee, including foreign government officials residing in or planning an imminent visit to the U. S., because of his official status.
2. Has attempted or threatened to redress a grievance against any public official by other than legal means.
3. Because of background is potentially dangerous; or has been identified as member or participant in communist movement; or has been under active investigation as member of other group or organization inimical to U. S.
4. U. S. citizens or residents who defect from the U. S. to countries in the Soviet or Chinese Communist blocs and return.
5. Subversives, ultrarightists, racists and fascists who meet one or more of the following criteria:
 - (a) Evidence of emotional instability (including unstable residence and employment record) or irrational or suicidal behavior;
 - (b) Expressions of strong or violent anti-U. S. sentiment;
 - (c) Prior acts (including arrests or convictions) or conduct or statements indicating a propensity for violence and antipathy toward good order and government.
6. Individuals involved in illegal bombing or illegal bomb-making.

Photograph has been furnished enclosed is not available
 may be available through _____

Very truly yours,

J. Edgar Hoover
John Edgar Hoover
Director

1 - Special Agent in Charge (Enclosure(s)2) (RM)
U. S. Secret Service, Nashville, Tenn.

Enclosure(s)

(Upon removal of classified enclosures, if any, this transmittal form
becomes UNCLASSIFIED.)



UNITED STATES DEPARTMENT OF JUSTICE

FEDERAL BUREAU OF INVESTIGATION

Knoxville, Tennessee

May 1, 1970

In Reply, Please Refer to
File No.

~~CONFIDENTIAL~~

RICHARD CLAXTON GREGORY
RACIAL MATTERS

Attached are copies of news articles appearing in the UT Daily Beacon, student publication, University of Tennessee (UT), Knoxville, Tennessee, The Knoxville News-Sentinel and The Knoxville Journal, daily publications, Knoxville, Tennessee.

APPROPRIATE AGENCIES AND FIELD OFFICES
ADVISED BY ROUTING SLIP ON 1-29-80 *pub.*

DECLASSIFIED ON 2842 pmv/EPm
BY 1-10-80

Group 1
Excluded from automatic
downgrading and declassification

~~CONFIDENTIAL~~

ENCLOSURE

100-440423-545

~~CONFIDENTIAL~~

(Mount Clipping in Space Below)

Gregory Speech Set

Dick Gregory, comedian turned civil rights activist, has been scheduled to speak on the UT campus May 7, according to an announcement made Tuesday by Mark Grisar, chairman of the Man and His Environment speaker series.

Grisar said Gregory, whose appearance on the campus has been twice vetoed by UT administrators, has already signed a contract.

Gregory was the first scheduled speaker ever to be denied permission to speak on the campus by UT administrators.

Georgia legislator Julian Bond added to the impact of the veto when he broke his contract to speak at UT when he learned the University had refused Gregory the right to speak on campus.

Bond told the Daily Beacon then that if Gregory wasn't good enough to speak at UT, he wasn't either.

The incident sparked the controversy, which eventually led to a lawsuit challenging the validity of the University's speaker policy.

It was decided in U.S. District Court here that the policy limited freedom of speech and was unconstitutional.

(Indicate page, name of newspaper, city and state.)

UT DAILY BEACON

KNOXVILLE, TENN.

PAGE 1

Student Publication,
University of
Tennessee

Date: 1/14/70
Edition:
Author:
Editor:
Title:

Character:
or
Classification:
Submitting Office: KNOXVILLE
 Being Investigated

~~CONFIDENTIAL~~

~~CONFIDENTIAL~~

(Mount Clipping in Space Below)

Crowd Fills Gym For Gregory

By Bruce Hight

America has run out of tricks, Dick Gregory said last night, and young Americans should "organize behind morality," this summer, to end the Vietnam war.

Gregory, speaking before a Man and His Environment crowd of 3,200 in Alumni Memorial Gym, said that President Nixon was the country's last trick.

"THEY ASK US to be non-violent," Gregory said, "But this is the only country in the world that ever dropped an atomic bomb on Japan."

He urged, "You young folks organize this summer, boycott the barbershops and I'll guarantee you that you'll have 300,000 barbers joining the peace movement."

The black comedian slammed the Federal Government for its methods of dealing with drug traffic by noting that had he never been in Knoxville before in his life, he could "get a fix" within 15 minutes after his arrival.

"IF A KID can find a heroin pusher," Gregory said, "you know the Federal government can."

Referring to the police and their attempts to halt the drug traffic, Gregory said, "They can't find the heroin, man?"

Gregory, who twice has been denied the right to appear at UT by the University Administration, walked up to the podium to begin his speech and said, "I'm happy to be in Knoxville." The crowd roared its approval.

GREGORY TOLD the audience that they, as the young generation, faced no problems that they had created.

"I feel particularly sorry for you young white kids," Gregory said, "because those bad checks your parents have been writing are gonna bounce."

Gregory endorsed the upcoming march in Nashville Sunday, telling the

(Indicate page, name of newspaper, city and state.)

UT DAILY BEACON

KNOXVILLE, TENN.

PAGE 1

Student Publication,
University of
Tennessee

Date:

4/10/70

Editor:

Author:

Editor:

Title:

Character:

or

Classification:

Submitting Office:

KNOXVILLE

Being Investigated

~~CONFIDENTIAL~~

~~CONFIDENTIAL~~

crowd that their marching could set an example for others who might be oppressed and encourage them.

THE BLACK activist also took aim at the drug abuse, and attacked whites for caring about the problem only after it had moved out of the black ghetto and other poverty areas and into the white suburban areas.

Gregory heavily criticized college students for not backing American workers saying, "Who the hell do you think you are?"

He said students had missed an opportunity to help American workers by virtually ignoring the mailmen's strike recently.

GREGORY ALSO blasted the trial of

the Chicago 7 and pointed out that the one black being tried was Tourey Seale, who was sent to jail before the end of the controversial judicial proceedings for contempt charges.

Gregory said Seale was not sent to jail for any courtroom behavior, but for asking Judge Julius Hoffman in court how much stock he had in the Brunswick Corporation, a maker of war weapons.

"It's a cold day in America when anti-war demonstrators end up in court before a judge who manufactures war materials," he said.

Gregory also told "the damn fools" who warn about the dangers of world-wide Communism to make the U.S. Constitution really work, and then say to them, "Top that, baby."



Staff Photo by Mike Borum

A full house for Gregory

~~CONFIDENTIAL~~

~~CONFIDENTIAL~~

(Mount Clipping in Space Below)

4000 Hear Nixon Scored

'We Used All the Tricks' Dick Gregory Tells This Generation

By JIM STOVALL
News-Sentinel Staff Writer

Dick Gregory, whose absence from UT, last year stimulated the open speaker controversy, told 4000 wildly enthusiastic students there last night that his generation has "used up all the tricks."

Mr. Gregory, a black comedian who was barred from UT last year by Chancellor Charles Weaver, said today's young people—the group to which he was speaking—are the "most morally honest, ethical group of young people in the history of the world."

"It's an embarrassing thing for me to say to you, but you are going to have to solve a lot of problems, and every one of those problems you had nothing to do with," he said.

Nixon Was 'Last Trick'

"Not only did we not solve the problems, we used up all the tricks," he said to the group, which was packed into Alumni Memorial Gymnasium.

The "last trick" was electing Richard Nixon president, he said. "Richard Nixon shows the state of the nation far better than anything else in this country."

"Out of 200 million people in this country, he had to pick one person moral enough to fill a vacancy on the Supreme Court—and the most ethical man he could come up with was a Haynsworth.

"On the second time around, he reached even further down the barrel of scum and got a Caravell. His nomination was

an insult to every decent thinking person on the face of the earth!"

Predicts Defeat

Mr. Gregory then, as he was many times during his speech, was interrupted by loud applause, cheers, stomping feet, and whistling.

The civil and human rights advocate predicted that Nixon, the "dumbest white boy ever to be in the White House," would be defeated in 1972 because he is "tampering with the money."

"Within the next six months, we will be reaching the economic low point of our history, and the same white folks that put him (Nixon) in the White House are going to take him out. The 'silent majority' is going to be the most vocal group you ever heard," he said.

Mr. Gregory said the older generation is so interested in making money that "a moral thought hasn't penetrated their heads in the last 20 years."

'Police Not Real Enemy'

"That's why it's so hard for you to communicate with your parents," he told the group.

Mr. Gregory, who termed himself "strongly committed to non-violence" said that young people should "rally, behind morality" and protest, not by dynamiting buildings or blowing up police stations.

"The police stations aren't your real enemies. Your real enemies are the Rockefellers, the Kennedys, the Henry Fords, and the Du Ponts. After you've blown up all the police stations,

(Indicate page, name of newspaper, city and state.)

PAGE 10

THE KNOXVILLE NEWS-SENTINEL

KNOXVILLE, TENN.

Date: 4/10/70
Edition: HOME
Author:
Editor: RALPH L. MILLETT
Title:

Character:
or
Classification:
Submitting Office: KNOXVILLE
 Being Investigated

~~CONFIDENTIAL~~



—News-Sentinel Staff Photo

they'll still be around polluting your air and water," he said. The 1968 presidential candidate fixed sharp rebukes on conservatives and right-wingers, "who have substituted the word 'patriotic' for 'neurotic'."

Applause Long, Loud

"You fools are so interested in worldwide communism. You would implement your own Constitution to the fullest, and then say to the rest of the world, 'Match us for humanity.'"

This remark drew the loudest and longest applause from the crowd.

"The most important question you young people face is this: If democracy is as good as we say it is, why are we running around the world trying to ram it down people's throats at gunpoint?" he said.

Offers Solution

Mr. Gregory, among many other subjects, talked about the Chicago 7 trial in his two-and-a-half hour speech. He said he recognized the need for order in the court and offered a solution for disruptive defendants.

"If a defendant disrupts the courtroom, stop the trial and give him 10 days in jail for contempt. If he comes back and disrupts the trial again, stop the trial and give him 20 days in jail," he said.

Gregory said judges should do this immediately and not "sit back and add the contempt citations up," as Judge Hoffman did at the Chicago trial. The contempt sentences should be carried out immediately.

"Any time the authorities sit

OPEN SPEAKER—Dick Gregory emphasizes a point during his speech last night at UT. His appearance on campus was denied twice before the courts declared UT's policy on speakers unconstitutional.

back and add things up, they've got something on their minds besides law and order," he said.

Mr. Gregory's speech marks the symbolic end to a year-and-a-half struggle for an open speaker policy on the UT campus. When he was vetoed by Chancellor Weaver in September, 1968, and re-vetoed the next February, the campus began struggling with its first major student-administration controversy.

KC Students Attend

That controversy ended in Judge Robert L. Taylor's Second District Federal Court in April, where UT's closed speaker policy was ruled unconstitutional.

The speech last night was attended by many Knoxville College students as well as UT students.

One minor incident occurred just before the speech began. Two white students entered the balcony draped in Confederate flags. They were torn off, after a brief struggle, by four black students, and then the flags

were ripped apart by several other black students.

Mr. Gregory's speech was laced with the wit that made him one of America's top comedians before he undertook his Civil Right struggle several years ago.

Blame It on Others

He said he was frequently asked why there were no riots last summer. He doesn't really know, he said, but he always says that Negro leaders "were in Ireland serving as technical advisors."

"You know, it makes no difference who's rioting, the police always react in the same way. They always blame it on outside agitators. In Ireland, it's Billy Graham and the Pope.

"Did you ever stop to think about all the religious struggles going on in the world today? It kind of makes you wonder what great secret the atheists have that makes them act so godlike."

~~CONFIDENTIAL~~

(Mount Clipping in Space Below)

Dick Gregory: We Seek 'Rights By Constitution'

Human rights activist Dick Gregory leveled verbal attacks at almost every American institution here Thursday but wound up by saying minority groups "want their rights on the same piece of paper that others have them the U.S. Constitution."



Gregory

Gregory told the more than 3300 persons at the University of Tennessee Alumni Gymnasium "young people need to organize behind morality," in an effort to change this country.

On the issue of law and order the 38-year-old comedian said, "the same racist system which guns down the blacks that mean something to me is the same system which allows politicians

and cops to turn their heads to black pimps and prostitutes."

"Authorities are not supposed to sit by and let violations build up for a grand total before acting; that's not law and order." His example of this was "Judge Hoffman in the Chicago 7 trial sending everyone to jail while the jury was out and allowing the contempt of court violations build up until the end of the trial."

He also struck out at the nation's abandonment of "moral thinking" in favor of making money.

"The old fools like the Rockefellers, the Duponts and others think morality is a clean shave, a haircut and a Brooks Brothers suit."

"When they talk about God bless America, they are really talking about the stock market. When they talk about America the beautiful, they are talking about their check books."

"About the administration's foreign policy he said "if Democracy is as good as we say it is why are we going all over the world trying to ram it down people's throats with a gun?"

"Young people must make Democracy something that others will want, not something to be forced on them."

Switching to busing students to achieve racial balance Gregory said, "you white folks have been busing black kids past white schools for 50 years to segregate students and now you act as though Negroes invented busing last week."

In closing he said young people must work to change the moral structure "without burning down police stations and killing cops."

(Indicate page, name of newspaper, city and state.)

The Knoxville Journal

Knoxville, Tenn

PAGE 25

Date: 4-10-70
Edition: CITY
Author:
Editor: W. F. CHILDRESS
Title:

Character:
or
Classification:
Submitting Office: KNOXVILLE

Being Investigated

~~CONFIDENTIAL~~

~~CONFIDENTIAL~~

RICHARD CLAXTON GREGORY

A source, who has furnished reliable information in the past, advised on April 14, 1970, that DICK GREGORY, from Chicago, Illinois, spoke at the UT Alumni Gym, Knoxville, Tennessee, on April 9, 1970, from approximately 8:10 p.m. until 10:25 p.m. There were approximately 3,500 people in attendance including black and white students and adults.

Prior to his appearance on the stage, AVON ROLLINS, employed Tennessee Valley Authority, Knoxville, Tennessee, appeared on the stage shortly and then departed.

DICK GREGORY stated that the white man had run out of tricks and that electing President NIXON was the last trick. He stated this country is based on money and when the ROCKEFELLERS, KENNEDYS, and DU PONTs stop polluting this country there will be no money left.

He said that white children love "pot" because they were taught that black children could obtain it and get more thrills than the white parents could with alcohol.

He urged every student to go to the library and copy the Declaration of Independence, indicating when we march in Washington, we can say "We hold these truths to be self evident." He stated it is the right of the people to overthrow the Government at which time he was cheered and applauded.

He said a march would be held all over the country, including Knoxville, on April 15, 1970, and indicated the Declaration of Independence should be read at that time.

He said the word "pig" originated from the Bible and this information can be found in the Gospel of Mark. He referred to the police as "pigs" and indicated they are after the Panthers and are protecting dope pushers. He said within 15 minutes after he arrived in Knoxville he could find a place to buy dope and criticized the police department for not being able to find these places and that even a 15 year-old child can buy dope. He said that "pigs"

~~CONFIDENTIAL~~

~~CONFIDENTIAL~~

RICHARD CLAXTON GREGORY

are Fascists and that the police pick up prostitutes for their own "game."

He invited everyone to come to Washington, D. C., on July 4th for a march.

He jokingly indicated he wanted his money therefore he could not be a communist as he loves money too much, but did indicate the communists love money also.

~~CONFIDENTIAL~~

~~CONFIDENTIAL~~

1

BLACK PANTHER PARTY (BPP)

According to its official newspaper, the Black Panther Party (BPP) was started during December, 1966, in Oakland, California, to organize black people so they can take control of the life, politics, and the destiny of the black community. It was organized by Bobby George Seale, BPP Chairman, and Huey P. Newton, BPP Minister of Defense. Newton is presently serving a sentence of 2 to 15 years on a conviction of manslaughter in connection with the killing of an Oakland police officer.

The official newspaper, "The Black Panther," which further describes itself as the "Black Community News Service," states that the BPP advocates the use of guns and guerrilla tactics in its revolutionary program to end oppression of the black people. Residents of the black community are urged to arm themselves against the police who are consistently referred to in the publication as "pigs" who should be killed.

"The Black Panther" issue of September 7, 1968, contains an editorial by BPP Minister of Education, George Mason Murray, which ends with the following:

"Black men. Black people, colored persons of America, revolt everywhere! Arm yourselves. The only culture worth keeping is a revolutionary culture. Change. Freedom everywhere. Dynamite! Black Power. Use the gun. Kill the pigs everywhere."

Included in the introduction to an article appearing in the October 5, 1968, edition of "The Black Panther" is the statement, "... we will not dissent from American Government. We will overthrow it."

Issues of "The Black Panther" regularly contain quotations from the writings of Chairman MAO Tse-tung of the People's Republic of China and feature MAO's statement that "political power grows out of the barrel of a gun."

2

BPP

The national headquarters of the BPP is located at 3106 Shattuck Avenue, Berkeley, California. Branches have been established at various locations throughout the United States.

This document contains neither recommendations nor conclusions of the F. B. I. It is the property of the F. B. I. and is loaned to your agency; it and its contents are not to be distributed outside your agency

11 *

F B I

Date: 4/30/70

Transmit the following in _____
(Type in plaintext or code)

Via AIRTEL _____
(Priority)

wcs/jmw

TO: DIRECTOR, FBI
FROM: SAC, CHARLOTTE (157-7455) (C)
APPEARANCE OF RICHARD CLAXTON GREGORY
N. C. STATE UNIVERSITY
RALEIGH, N. C.
3/2/70
RM

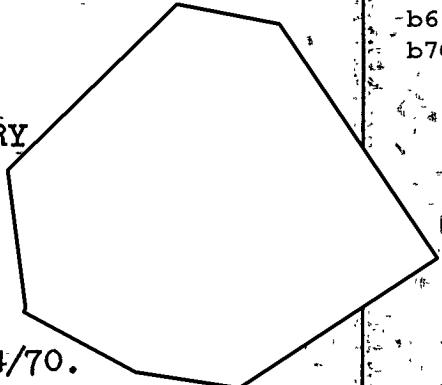

b6
b7C

Re Charlotte airtel to Director, 3/4/70.

Enclosed for Chicago is one copy each of memoranda at Charlotte, N. C., dated 2/25/70 and 3/4/70, and one copy each of Charlotte airtels to Director, dated 2/25/70 and 3/4/70, both captioned as above.

On 3/27/70

[redacted] whose identity should be protected, made available a tape of the speech of GREGORY made 3/2/70 which he had obtained from N. C. State University authorities.

b6
b7C
b7D

A review of this type reflects substantially the same information as that furnished by [redacted] Alcohol, Tobacco & Firearms, Raleigh, which is set forth in LHM of 3/4/70.

UACB, the tape will be maintained as an exhibit in the Charlotte file and will not be transcribed in its entirety.

REC-29

100-440423-550

- ② - Bureau (RM)
- 2 - Chicago (157-347) (Enc. 4) (RM)
- 2 - Charlotte (1 - 157-7455)

THG:dh
(6)

10 MAY 2 1970

DO NOT INTERFERE

59 MAY 13 1970

RACIAL INT. SECT.

Approved: _____
Special Agent in Charge

Sent _____ M Per _____

pm 2/24/70
1-10-80

FEDERAL BUREAU OF INVESTIGATION
COMMUNICATIONS SECTION

APR 2 1970

TELETYPE

Mr. Tolson	_____
Mr. DeLoach	_____
Mr. Walters	_____
Mr. Mohr	_____
Mr. Bishop	_____
Mr. Casper	_____
Mr. Callahan	_____
Mr. Conrad	_____
Mr. Felt	_____
Mr. Gale	_____
Mr. Rosen	_____
Mr. Sullivan	_____
Mr. Tavel	_____
Mr. Soyars	_____
Tele. Room	_____
Miss Holmes	_____
Miss Gandy	_____

NR004 SI PLAIN

555 PM URGENT 4/2/70 CEK

TO DIRECTOR

FROM SPRINGFIELD (157-189)

DICK GREGORY, APPEARANCE SPALDING INSTITUTE GYMNASIUM,
PEORIA, ILLINOIS, APRIL FOUR NEXT, RACIAL MATTERS.

ON APRIL TWO INSTANT, A SOURCE WHO HAS FURNISHED
RELIABLE INFORMATION IN THE PAST, ADVISED THAT DICK
GREGORY IS TO SPEAK AT SPALDING INSTITUTE GYMNASIUM,
FOUR ZERO NINE NORTHEAST MADISON STREET, PEORIA, ILLINOIS,
ON APRIL FOUR NINETEEN SEVENTY AT SEVEN THIRTY P.M.
GREGORY'S APPEARANCE IS BEING SPONSORED BY THE TAZEWELL
COUNTY HUMAN RELATIONS COMMITTEE AND IS OPEN TO THE GENERAL
PUBLIC, COST ONE DOLLAR FIFTY CENTS STUDENTS, THREE DOLLARS
ADULTS. GREGORY IS TO SPEAK ABOUT HIS BOOK ENTITLED
"NIGGER", HIS CHILDHOOD EXPERIENCES AND WHAT THE PEOPLE
IN THE PEORIA, ILLINOIS AREA CAN DO TO HELP BETTER RELATIONS
BETWEEN BLACK AND WHITES. ONLY PROPS REQUESTED WAS A
PODIUM, SPEAKER SYSTEM AND PIANO. SOURCE ADVISED NO

END PAGE ONE

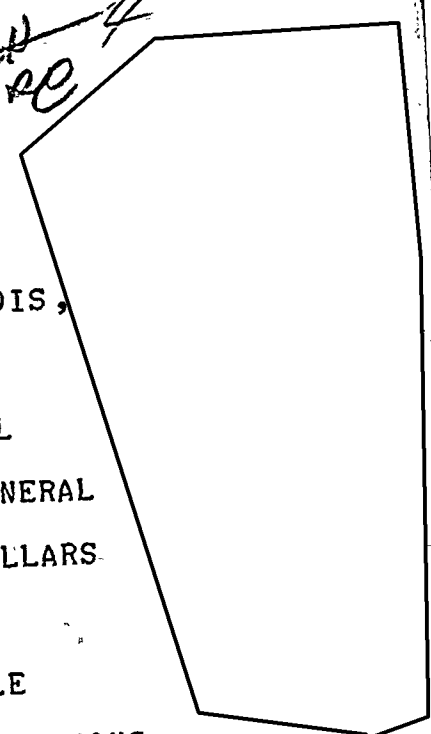

b6
b7c

100-440423-551

REC-29

APR 17 1970

TELETYPED TO:

FTB

2 - ENCLOSURE

APR 14 1970

APR 3 1970

EPB COPY SENT

IDIU

MR. DELOACH FOR THE DIRECTOR

SI 157-189

PAGE TWO

DISTURBANCES EXPECTED.

ADMINISTRATIVE: SOURCE REFERRED TO IS
CONFIDENTIAL RACIAL SOURCE. LOCAL AND FEDERAL AGENCIES
ADVISED.

BUREAU AUTHORITY IS REQUESTED TO RECORD GREGORY'S
APPEARANCE. RECORDING DEVICES WILL BE CONCEALED TYPE, CARRIED
BY SPECIAL AGENTS. SECURITY MEASURES WILL BE
EMPLOYED TO ASSURE FULL PROTECTION TO BUREAU PERSONNEL AND
PROPERTY. P.

END

JTJ FBI WAWHXX WASH DC

b6
b7C
b7D

CC- MR. SULLIVAN

4/2/70

TO DIRECTOR
FROM SPRINGFIELD

DICK GREGORY , APPEARANCE SPALDING INSTITUTE GYMNASIUM,
PEORIA, ILLINOIS, APRIL FOUR NEXT, RACIAL MATTERS.

ON APRIL TWO INSTANT, A SOURCE WHO HAS FURNISHED
RELIABLE INFORMATION IN THE PAST, ADVISED THAT DICK
GREGORY IS TO SPEAK AT SPALDING INSTITUTE GYMNASIUM,
FOUR ZERO NINE NORTHEAST MADISON STREET, PEORIA, ILLINOIS,
ON APRIL FOUR NINETEEN SEVENTY AT SEVEN THIRTY P.M.
GREGORY'S APPEARANCE IS BEING SPONSORED BY THE TAZEWELL
COUNTY HUMAN RELATIONS COMMITTEE AND IS OPEN TO THE GENERAL
PUBLIC, COST ONE DOLLAR FIFTY CENTS STUDENTS, THREE DOLLARS
ADULTS. GREGORY IS TO SPEAK ABOUT HIS BOOK ENTITLED
"NIGGER", HIS CHILDHOOD EXPERIENCES AND WHAT THE PEOPLE
IN THE PEORIA , ILLINOIS AREA CAN DO TO HELP BETTER RELATIONS
BETWEEN BLACK AND WHITES. ONLY PROPS REQUESTED WAS A
PODIUM, SPEAKER SYSTEM AND PIANO. SOURCE ADVISED NO
DISTURBANCES EXPECTED.

100-440423-551

~~157-16906-8~~

This document contains neither
recommendations nor conclusions of
the FBI. It is the property of
the FBI and is loaned to your agency;
it and its contents are not to be
distributed outside your agency.

ENCLOSURE

COPY SENT

IDIU

Domestic Intelligence Division

INFORMATIVE NOTE

Date 4/2/70

Attached states that Negro comedian Dick Gregory will speak in Peoria, Illinois, on 4/4/70. His speech will concern his book entitled "Nigger." Speech will be open to public and our Springfield Office has requested authority to record Gregory's speech.

If you approve, our Springfield Office will be instructed to record Gregory's speech provided full security can be assured. A copy of attached has been sent to Inter-Division Information Unit.

ABK:wmk

wes
ABK

WSS

he

ASAC Sullivan
12:05 P.M. 4/3/70
instructed OK.

✓

100-440423-561
~~15716706 2~~

ENCLOSURE

FEDERAL BUREAU OF INVESTIGATION
COMMUNICATIONS SECTION

APR 5 1970

TELETYPE

Mr. Tolson	_____
Mr. DeLoach	_____
Mr. Walters	_____
Mr. Mohr	_____
Mr. Bishop	_____
Mr. Casper	_____
Mr. Callahan	_____
Mr. Conrad	_____
Mr. Felt	_____
Mr. Gale	_____
Mr. Rosen	_____
Mr. Sullivan	_____
Mr. Tavel	_____
Mr. Soyars	_____
Tele. Room	_____
Miss Holmes	_____
Miss Gandy	_____

b6
b7C

R 003 SPRINGFIELD PLAIN
1150PM NITEL 4-4-70 DJK
TO DIRECTOR
FROM SPRINGFIELD (157-189)

hr *was pro*

APPEARANCE OF DICK GREGORY, SPALDING INSTITUTE GYMNASIUM,
PEORIA, ILLINOIS, APRIL FOUR, NINETEEN SEVENTY. RM.

DICK GREGORY, NEGRO ANTI-ESTABLISHMENT COMIC, APPEARED
THIS DATE AT SPALDING GYMNASIUM, PEORIA, ILLINOIS AND SPOKE
FOR TWO HOURS BEFORE MIXED CROWD APPROXIMATELY TWO HUNDRED-
FIFTY PERSONS. GREGORY-S SPEECH WAS IN ESSENCE THE SAME AS
HIS RECORD ENTITLED, "THE LIGHT SIDE, THE DARK SIDE".

GREGORY CRITICIZED PRESIDENT NIXON-S GENERAL INTELLIGENCE,
HIS POLICY, BOTH DOMESTIC AND FOREIGN, AS WELL AS HIS
APPOINTEES TO THE SUPREME COURT. HE ALSO CRITICIZED ATTORNEY
GENERAL JOHN MITCHELL-S "OPERATION INTERCEPT", IN AS MUCH AS
THE OPERATION DOES NOT HAVE ANY EFFECT ON THE INFLUX OF HEROIN
TO THE UNITED STATES. GREGORY CRITICIZED THE YOUNG PEOPLE FOR

100-440423-552

REC 4

~~157-16906-4~~

APR 16 1970

END PAGE ONE

TELETYPE UNIT (FILE COPY ATTACHED)

TELETYPE TO:
59 APR 22 1970
N 3 1970 ERB

*0-7 to SA 4/14/70: copy
submit to the SA in a copy
not original of the ref. tape
along with a verbatim transcript
shorthand for discussion
JCM/ci*

(Tape)

PAGE TWO

NOT SUPPORTING THE POSTAL STRIKE.

NO DISTURBANCES OR INCIDENTS OCCURRED.

ADMINISTRATIVE: RE SPRINGFIELD TEL APRIL TWO LAST.

RECORDING OBTAINED, LHM FOLLOWS AFTER TRANSCRIPTION. LOCAL
AND FEDERAL AGENCIES COGNIZANT.

END

RM FBI WASH DC

CLR

MR. TRAINOR
ROOM 836 9&D

4-4-70

TO DIRECTOR
FROM SPRINGFIELD

APPEARANCE OF DICK GREGORY, SPALDING INSTITUTE GYMNASIUM,
PEORIA, ILLINOIS, APRIL FOUR, NINETEEN SEVENTY. RM.

DICK GREGORY, NEGRO ANTI-ESTABLISHMENT COMIC, APPEARED
THIS DATE AT SPALDING GYMNASIUM, PEORIA, ILLINOIS AND SPOKE
FOR TWO HOURS BEFORE MIXED CROWD APPROXIMATELY TWO HUNDRED
FIFTY PERSONS. GREGORY-S SPEECH WAS IN ESSENCE THE SAME AS
HIS RECORD ENTITLED, "THE LIGHT SIDE, THE DARK SIDE".
GREGORY CRITICIZED PRESIDENT NIXON-S GENERAL INTELLIGENCE,
HIS POLICY, BOTH DOMESTIC AND FOREIGN, AS WELL AS HIS
APPOINTEES TO THE SUPREME COURT. HE ALSO CRITICIZED ATTORNEY
GENERAL JOHN MITCHELL-S "OPERATION INTERCEPT", IN AS MUCH AS
THE OPERATION DOES NOT HAVE ANY EFFECT ON THE INFLUX OF HEROIN
TO THE UNITED STATES. GREGORY CRITICIZED THE YOUNG PEOPLE FOR
END PAGE ONE

This document contains neither
recommendations nor conclusions of
the FBI. It is the property of
the FBI and is loaned to your agency;
it and its contents are not to be
distributed outside your agency.

100-440423-552

~~157-16906-4~~

ENCLOSURE

DO

O

PAGE TWO

NOT SUPPORTING THE POSTAL STRIKE.

NO DISTURBANCES OR INCIDENTS OCCURRED.

UNITED STATES GOVERNMENT

Memorandum

TO : DIRECTOR, FBI

DATE: April 23, 1970

FROM : SAC, SPRINGFIELD (157-189) (P)

SUBJECT: DICK GREGORY,
APPEARANCE SPALDING
INSTITUTE GYMNASIUM,
PEORIA, ILLINOIS
APRIL 4, 1970
RM

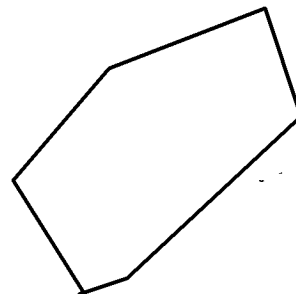

4
1.8

Re Springfield teletypes to the Bureau 4/2/70 and 4/4/70; and Springfield letter and LHM, 4/21/70.

Reference is also made to Bureau Routing Slip, 4/14/70, captioned "Black Extremist Tapes" which instructed Springfield to submit a copy of the tape together with a verbatim transcript suitable for dissemination.

b6
b7c

At the appearance of GREGORY two tape recording devices were utilized, one the stereophonic Mini-Phone recorder, and the other a cassette type recorder. It should be noted DICK GREGORY spoke in a partially filled hall varying his voice from extremely low to high pitched shouting and screaming with resultant reverberation and echo effects. His pronunciation was of poor quality and some of his words were clipped and hard while others were slurred, making the net result of such poor quality that the majority of the recordings are completely unintelligible. These tapes have been carefully monitored in the Springfield Office under as close to ideal conditions as can be obtained and where this individual's address could be understood we have been unable to distinguish any reference to threats, direct or veiled, to individuals of prominence in the government or clear statements which might incite others to violence and therefore, be of possible future evidentiary value.

REC-24 157-16906-5

The LHM submitted in referenced communication, 4/21/70, contains the salient points of GREGORY's presentation as obtained through personal observation by an Agent trained in racial matters who was in the audience. UACB due to the poor quality of the tapes, no further attempt will be made to copy and/or transcribe them but they are being retained in the Springfield Office.

- ② - Bureau (RM)
- 3 - Springfield (157-189)
- 1 - (176-1970) (CONTROL FILE - RECORDINGS OF NEW LEFT AND BLACK EXTREMISTS)

100-44042-553
APR 27 1970

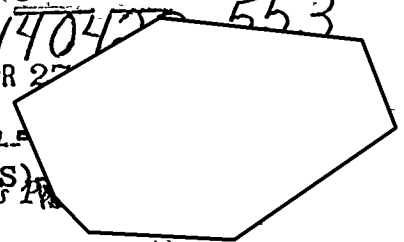

JUN 11 1970

Buy U.S. Savings Bonds Regularly on the Payroll Savings Plan

UNITED STATES GOVERNMENT

Memorandum

esa
5/1/70

TO : DIRECTOR, FBI (157-16906)

DATE: 4/28/70

FROM : SAC, HONOLULU (157-180) (RUC)

SUBJECT: RICHARD CLAXTON GREGORY, aka
Dick Gregory
RM
OO: Chicago

Re Honolulu letter to the Bureau, 3/25/70.

b6
b7c

Enclosed for the Bureau are seven copies of an LHM and two copies of the LHM for the Chicago Office, setting forth summary of speech delivered by GREGORY while he was in Honolulu on 4/17/70.

Agents observing GREGORY on 4/17/70 at the University of Hawaii, Honolulu, are SAs [redacted] RICHARD J. DOBENS and [redacted]

Agent who listened to speech by GREGORY over KGMB-TV on 4/19/70 is SA [redacted]

No further investigation remains to be conducted by the Honolulu Office.

ALL INFORMATION CONTAINED
HEREIN IS UNCLASSIFIED
DATE 1-10-80 BY pmu 2842/SPM

- 2 - Bureau (Enc. 7) (RAM)
- 2 - Chicago (Enc. 2) (RAM)
- 1 - Honolulu

TC:esn
(5)

AGENCY: ACSI, ~~NSC~~, OSI, SEC. SERV.,
DEPT: ISD, ~~OSI~~, IDIU

HOW FORW: *R/S*
DATE FORW: *5/1/70*
BY: *[signature]*

ENCLOSURE

REC 16 100-440423-554
~~157-16906-6~~

MAY 4 1970

SEE REVERSE SIDE FOR
ADD. DISSEMINATION



JUN 1970 EPB

Buy U.S. Savings Bonds Regularly on the Payroll Savings Plan



UNITED STATES DEPARTMENT OF JUSTICE
FEDERAL BUREAU OF INVESTIGATION

In Reply, Please Refer to
File No.

Honolulu, Hawaii

April 28, 1970

RICHARD CLAXTON GREGORY,
Also Known As Dick Gregory

On April 17, 1970, Special Agents of the Federal Bureau of Investigation observed the following:

At 12:30 p.m., April 17, 1970, DICK GREGORY, under the sponsorship of the Associated Students, University of Hawaii (UH), Honolulu, a legitimate student organization, delivered a speech at Andrews Amphitheater, UH.

GREGORY's speech was replete with humor and was well received by more than 5,000 individuals, mostly comprising of students.

GREGORY said he spends approximately 98% of his time on college campuses and his reason for doing this is that the young people today are probably the most highly dedicated college career group of young people that has ever lived in the history of this country. GREGORY said one problem he finds with young people is they still depend upon old Right Wing newspapers to tell them who they are and what they ought to

* * * * *

This document contains neither recommendations nor conclusions of the FBI. It is the property of the FBI and is loaned to your agency; it and its contents are not to be distributed outside your agency.

100-440423-554
~~157-16906-6~~

(ENCLOSURE) ALL INFORMATION CONTAINED
HEREIN IS UNCLASSIFIED
DATE 1-10-80 BY PMJ 2842/CM

Re: RICHARD CLAXTON GREGORY

buy. GREGORY said the average established newspaper in America is not morally sound enough to discuss matters with young kids. GREGORY added it is embarrassing to him when he has to say to young people that all the problems confronting America today will have to be solved by the young people even though these problems were here before the young people arrived. GREGORY said "thanks to us old fools" these problems will not be here when you leave.

Much of GREGORY's speech was devoted to criticizing Vice President SPIRO AGNEW. In this respect GREGORY said, "You know a lot of people are kinda down on AGNEW but in all honesty, I must admit I kinda dig AGNEW myself. I figure that because I think AGNEW's puttin' everybody on. I don't think it's humanly possible for one man to be born that dumb. You know that if AGNEW was as dumb as he wants us to believe he is, he wouldn't be able to walk and chew gum at the same time. And what I like about AGNEW, you can say anything you want about him but at least you have to admit he is consistent. And I wouldn't be surprised if AGNEW got on television next week and called NIXON a honkie. And even just the thought that AGNEW went to public school is enough to make everyone want to go to private schools."

In speaking about discriminatory conditions in Hawaii, GREGORY said the young people in Hawaii have a special problem. They have a big job. He said, "The Lord give birth to Hawaii. How many Hawaiians can you find here? Which makes you just as guilty as that other freak." ... "You check out the representatives in Congress, three of em yellow, four of em yellow, right? Three of em Japanese, one Chinese, who's representing the folks? The brown people have really got a thing, but you yellow folks got a thing, too. You might be a little bit comfortable over here, but baby that cat don't give no more damn about you than he do about me. And if you don't believe that, you check

Re: RICHARD CLAXTON GREGORY

out, you check out what the yellow folks got. Four representatives in Congress and that white man got his arms around you telling you all that -- OBSCENE --, but if you check out the state mental hospital here, it's full of yellow folks. There's something wrong somewhere. Evidently you're not as comfortable as you want people to believe you are."

In speaking about President RICHARD NIXON, GREGORY said, "I guess when you stop and think about it, that NIXON got into the White House on the last trick this country had to offer. He ain't nothin' but an old tricky President. And if you get a good look at him the next time you see him on television, look at him. He don't even look like he believes he's President. And if you look at those last two Supreme Court nominations, he don't think like he believes he's a President."

GREGORY said, "I tell you what happened. White folks in America dirtied up the word black, not us. White folks in America corrupted power, not us. Then one day we come through with two legitimate words 'Black Power' and the white folks go crazy."

In speaking about economic conditions in America, GREGORY said that he was in Detroit, Michigan, during the month of March, 1970 and that he had been in Seattle, Washington, at the Boeing Aircraft Corporation and he had noted that unemployment in the United States had rose 46%. He mentioned that almost all Americans and particularly politicians are concerned only about money. He said when we talk about "God Bless America", what we really mean is "that's the stock market". When we say "America the Beautiful" ... "that's the bank". GREGORY said, "And NIXON fixin' to mess with the money. Where do you ever see In God We Trust? On the church, on the Bible, on the court

Re: RICHARD CLAXTON NIXON

or on the money? And you ain't seen no fools that crazy. Damn NIXON, he's messin' with the jolly green Jesus nowadays. That's all we think about in this country, that money. We said you were a sick insane nation, well, I'm sure you all have read about the buildings that got blown up in New York City. Every newspaper in America has written an editorial about those buildings that was blown up in New York City. Let me ask you something. Are you aware that ten days before the buildings were blown up in New York City, did you read the worldwide news that went out on a little town called Danbury, Connecticut, where a bunch of degenerate men stuck up a bank one day? Did you read that? And they set off ten dynamite blasts all over the town to get the police out. ... Not one newspaper in America has written an editorial about the bombings in Danbury, Connecticut. Only about the bombings in New York City because we are such a sick nation as long as we use some dynamite to try and get you some money, we will understand."

GREGORY said that on one occasion, NIXON appeared on nation-wide television and said that he was going to do everything he could to slow up integration of schools in the South. GREGORY said that before this time, 'Black folks' were so busy they weren't too concerned as to progress of integration of schools in the South. However, when they heard NIXON make this statement, they organized and as a result they promoted integration in more schools in the South within the last two months than what they did in the last 15 years.

GREGORY criticized school teachers in America stating that they were only interested in money. He told the students present that the schools belong to them. He criticized school teachers for not going on strike when President NIXON vetoed the educational bill.

Re: RICHARD CLAXTON GREGORY

GREGORY announced that the Chicago conspiracy defendants would appear in Hawaii the following week. He said those present should listen to what these men have to say. He said that young folks should not listen to their parents' conclusion of the Chicago conspiracy trial. He said, "JULIUS HOFFMAN's actions in Chicago made HITLER look like he had a whole lot of class. You listen to these old fools and all they talk about is, well, you've got to have order in the court." In referring to the treatment received by BOBBY SEALE, Chairman of the Black Panther Party (BPP), GREGORY said the other defendants said far more vicious things in the courtroom than what SEALE said but they did not have tape placed over their mouths. He said on one morning when the Judge came into the courtroom, BOBBY SEALE said to the Judge, how much stock do you own in the Brunswick Company. GREGORY said you should check into the Brunswick Company and you will find the Brunswick Company is one of the largest industries for manufacturing of machine guns and dynamite. He said, "It's a cold, dirty America when antiwar demonstrators end up on trial in a courtroom with a judge that manufactures the war materials."

In terminating his speech, GREGORY said, " ... and endowed by the creator with certain inalienable rights and when these rights are destroyed over long periods of time, it is your duty to destroy or abolish that government."

A characterization of the BPP is appended hereto.

On April 19, 1970, GREGORY appeared on KGMB-TV between the hours of 9:30 p.m. and 10:30 p.m. along with CECIL HEFTEL, President of KGMB. HEFTEL mentioned this session was intended to be a question and answer session. However, GREGORY did most of the talking and only four or five questions were presented to GREGORY by an audience in the television studio of approximately 20 individuals.

Re: RICHARD CLAXTON GREGORY

GREGORY at this time devoted most of his speech to the plight of the Black people and the difficulties the Black people are encountering in becoming first-class citizens. GREGORY criticized present conditions existing in the United States and for the most part discussed discriminatory practices against the Black man as he has personally experienced.

BLACK PANTHER PARTY,
Also Known As
Black Panther Party for Self-Defense

According to its official newspaper, the Black Panther Party (BPP) was started during December, 1966, in Oakland, California, to organize black people so they can take control of the life, politics and the destiny of the black community. It was organized by Bobby Seale, BPP Chairman, and Huey P. Newton, BPP Minister of Defense. Newton was sentenced in 1968 to serve 2 to 15 years after being convicted of manslaughter in connection with the killing of an Oakland police officer.

The official newspaper, "The Black Panther," which further describes itself as the "Black Community News Service," states that the BPP advocates the use of guns and guerrilla tactics in its revolutionary program to end oppression of the black people. Residents of the black community are urged to arm themselves against the police who are consistently referred to in the publication as "pigs" who should be killed.

"The Black Panther" issue of September 7, 1968, contains an editorial by BPP Minister of Education, George Mason Murray, which ends with the following:

"Black men. Black people, colored persons of America, revolt everywhere! Arm yourselves. The only culture worth keeping is a revolutionary culture. Change. Freedom everywhere. Dynamite! Black Power. Use the gun. Kill the pigs everywhere."

Included in the introduction to an article appearing in the October 5, 1968, edition of "The Black Panther" is the statement "...we will not dissent from American Government. We will overthrow it."

Issues of "The Black Panther" regularly contain quotations from the writings of Chairman MAO Tse-tung of the People's Republic of China and feature MAO's statement that "political power grows out of the barrel of a gun."

The national headquarters of the BPP is located at 3106 Shattuck Avenue, Berkeley, California. Branches have been established at various locations throughout the United States.

FBI

Date: 5/22

Transmit the following in _____
(Type in plaintext or code)

Via AIRTEL AIR MAIL
(Priority)

To: Director, FBI ATTENTION:
 CIVIL RIGHTS SECTION
From: SAC LOUISVILLE (157-1102) (C) GENERAL INVEST. DIV.
 DOMESTIC INTELLIGENCE DIV.
Subject: APPEARANCE OF COMEDIAN
DICK GREGORY AS SPEAKER
AT KENTUCKY STATE COLLEGE, FRANKFORT, KENTUCKY
MAY 10, 1970

- CR EL VRA-65 CRA-64
- PA PE PF
- BM BM-Threats Racial Matters
- Klan Organization

Summary of Complaint:

Attached hereto are the original and seven copies of an LHM containing a summary of comments made by GREGORY on the occasion of his appearance at the above educational institution on 5/10/70.

REC-89 100-440423-555

Doctor CARL M. HILL, President, Kentucky State College, Frankfort, Kentucky, on 5/14/70 advised a verbatim taped recording of GREGORY's remarks had been made by an official of the College. Because of the length of GREGORY's speech, which was two hours, the recording is not being obtained for transcription, by the Louisville Office. However, same

ENCLOSURE

- 3-Bureau (Enc. 8) (RM) } destroyed
- 1-Chicago (Enc. 1) (Info) (157-347) (RM)
- 1-Louisville
- TFK/pkd

(5) ACTION: UACB:

- No further action being taken and
- LHM enclosed Copy furnished to USA
- LHM being submitted
- Report being submitted
- Preliminary investigation instituted
- Limited investigation instituted

Copy to ASST. Dir. ISD/SPRU
by routing slip for
 info action
date 5/27/70
by [signature]

16 MAY 25 1970

ALL INFORMATION CONTAINED
HEREIN IS UNCLASSIFIED
DATE 1-10-88 BY 2002-pmf/ean

UNRECORDED COPY FILED IN 62-1097

SEE REVERSE SIDE FOR
ADD. DISSEMINATION

60 JUN 1 1970
Special Agent in Charge

LS 157-1102

will be available for transcription should such be required at a later date.

Copies of the enclosed LHM have been disseminated to 109th MIG, Louisville, Kentucky.

Copy being furnished Chicago as a matter of information regarding DICK GREGORY.



FEDERAL BUREAU OF INVESTIGATION
Louisville, Kentucky
May 22, 1970

In Reply, Please Refer to
File No.

APPEARANCE OF COMEDIAN,
DICK GREGORY AS SPEAKER
AT KENTUCKY STATE COLLEGE,
FRANKFORT, KENTUCKY
MAY 10, 1970
RACIAL MATTERS

On May 10, 1970, comedian Dick Gregory appeared as a guest speaker on the campus of Kentucky State College, Frankfort, Kentucky, a predominately Negro institution, after having been extended an invitation earlier to appear by the Performing Arts and Lecture Series Commission at Kentucky State College, F. C. Tillis, Chairman.

Detective [redacted] Kentucky State Police, Post Number 12, Frankfort, Kentucky, was assigned by the Intelligence Division, Kentucky State Police Headquarters, Frankfort, to attend the speech which lasted some two hours, was attended by approximately 300 members of the student body and faculty and various members of the Negro community, with only a scattering of white people present. Highlights of the speech which was made in Radford Hall on the campus beginning at 1:30 PM on May 10, 1970, were as follows, according to [redacted]

b6
b7c

Using colorful often profane phrases, Gregory attacked a broad spectrum of American society ranging from President Richard M. Nixon and Vice-President Spiro T. Agnew to Wall Street and the Peace Program. His sarcastic address drew immediate laughter and was interrupted by frequent applause.

Gregory insisted that black people should not hate the white people, but "hate this white racist system."

This document contains neither recommendations nor conclusions of the FBI. It is the property of the FBI and is loaned to your agency; it and its contents are not to be distributed outside your agency.

ALL INFORMATION CONTAINED
HEREIN IS UNCLASSIFIED
DATE 1-10-80 BY 282 pml/jcm

[Signature]
XEROX
JUN 1 1970

100-440423-555
ENCLOSURE

APPEARANCE OF COMEDIAN,
DICK GREGORY AS SPEAKER
AT KENTUCKY STATE COLLEGE,
FRANKFORT, KENTUCKY

Gregory described Nixon's election to the presidency as "the last trick the country had to offer." He alleged that Nixon's conservatism was just a way to make the racists respectable. He accused the President of being stupid and at one point referred to him as a tramp. He had sharp words for Vice-President Agnew and while criticizing Agnew as "dumb", he stated that the "only time Agnew frightens me is when Nixon is out of the country."

Gregory viewed the killing of white students at Kent State University in Ohio with mixed emotions. He pointed out that when three Negro students "got shot in the back" in a Southern college, "nobody got upset." He added that Nixon quickly cited that the throwing of dynamite be made a capital offense after several buildings were bombed in New York City. He contrasted this to the failure of the President to take any action when a Negro church was dynamited.

Gregory defended black power and drew loud applause when with a clenched fist he told the audience "that means morality." He described white reaction to the phrase as "them freaks went crazy."

With reference to the busing issue, Gregory exclaimed "you white folks have been busing Niggers past white schools for 50 years."

Gregory noted that Negro morality is continually subjected to a tax and lashed out at the morals of America's system which he described as "shimmy and degenerate." Gregory added that when the phrase God bless America is spoken, what is referred to is the stock market. He said some of the best dressed people who run Wall Street are "the slimiest degenerates."

Q D

APPEARANCE OF COMEDIAN,
DICK GREGORY AS SPEAKER
AT KENTUCKY STATE COLLEGE,
FRANKFORT, KENTUCKY

With reference to the recent peace rally in Washington, D.C. on the day before, Gregory stated that the reason there were so few blacks at this rally was that none wanted to participate in the movement when one of the foremost spokesman, Senator William Fulbright, "the racist pig from Arkansas," opposed every major civil rights legislation.

Gregory strongly opposed the war in Vietnam and stated that while he had heard pleas for non-violence at home, he could not understand how the leaders of Government could justify the bombing and napalming of children and women in Vietnam.

Gregory also criticized the fairness of the draft system and asked "how come these duPont kids don't get killed."

Gregory compared the Black Panthers to the American Indians and the genocide practices employed both against the American Indians and the Panthers.

Gregory added that Negroes viewed the trial of the Chicago 7 with mixed emotions and commented "we love to see all you white folks done in." With reference to Federal Judge Julius Hoffman, Gregory stated that Hoffman "would make Hitler look like he had a lot of class." He asked what kind of system it is which would allow defendants to violate order in the courtroom and then in the end slap them with long prison terms. Gregory contended that the first time anyone misbehaved in the courtroom, they should have been jailed for ten days and the punishment should be doubled if they repeat it.

Gregory also stated that nothing was done about the drug problem in this country until the use of drugs was expanded from the black ghettos to the suburbs.

APPEARANCE OF COMEDIAN,
DICK GREGORY AS SPEAKER
AT KENTUCKY STATE COLLEGE,
FRANKFORT, KENTUCKY

Gregory denied ever calling any policeman a pig but stated that he saw nothing wrong with this connotation. He said the reference was first made in the Bible and urged his listeners to look it up.

Gregory discussed other matters including Supreme Court nominees, the white exodus to the suburbs, looting during riots, civil rights leaders and boycotts.

He stated that the two men which President Nixon unsuccessfully nominated to the Supreme Court (G. Harrold Carswell and Clement Haynsworth) were "the slimiest degenerates possible."

He committed that the racism has propelled the white people to move to the suburbs turning over the cities to the black people.

He compared Martin Luther King, Rap Brown and Stokley Carmichael to George Washington and Patrick Henry as being liberators for human rights.

On May 11, 1970, Chief of Police Douglas True of the Frankfort City Police Department and Detective [redacted] of the Kentucky State Police, Frankfort, Kentucky, advised that there had been no disturbances as a result of the above speech delivered by Gregory at Kentucky State College and Gregory had left the college campus on Sunday afternoon, May 10, 1970, to deliver a speech to a Mormon gathering somewhere in the State of Utah.

b6
b7c

FBI

Date: MAY 28, 1970

~~CONFIDENTIAL~~

Transmit the following in _____
(Type in plaintext or code)

AIRTEL REGISTERED MAIL

Via _____
(Priority)

TO: DIRECTOR, FBI (100-440423)
FROM: SAC, BALTIMORE (157-2722) - C -
SUBJECT: RICHARD CLAXTON GREGORY
RM

TDR

Re airtel from Director to Baltimore, dated 4/15/70 and Baltimore teletype to Director, dated 4/8/70.

Enclosed for the Bureau are eight (8) copies of a Letterhead Memorandum (LHM), captioned "Appearance of Nationally Known Comedian, DICK GREGORY at Morgan State College, Baltimore, Maryland, April 9, 1970," and dated as above.

Local dissemination is as follows:

One copy each to:

OSI, NISO, Secret Service and USA, Baltimore, and four copies to 109th MI GP, Baltimore.

BA T-1 is

Baltimore, Maryland. requested his name be held confidential.

The LHM is being classified "Confidential-Group I" since disclosure of information contained therein could reasonably result in the identification of a confidential source of continuing value to the FBI and therefore compromise his future effectiveness.

- 2 - Bureau (ENC.8)
- 1 - Chicago (INFO)
- 1 - Baltimore

CL:bjp
(4)

AGENCY: ACISI, ISO, OSI, SEC. SERV., DEPT. OF JUSTICE, FBI, IDIU, G-2
HOW FORW: [Signature]
DATE FORW: 5/13/70
BY: [Signature]

ENCLOSURE REC-79

100-440425-556

54 JUN 9 1970

CLASS. & EXT. BY 2842 PAV/PAW
DATE OF EXT. 5-28-92

Approved: _____
Special Agent in Charge

Sent _____

~~CONFIDENTIAL~~

b6
b7C
b7D

b6
b7C

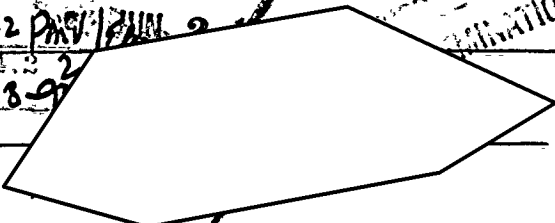

BA 157-2722

b6
b7C
b7D

~~CONFIDENTIAL~~

On 4/20/70, [REDACTED]

[REDACTED] of Morgan State College, Baltimore, Maryland, were contacted to determine if they had knowledge of anyone that had taped GREGORY's speech, and both advised they would attempt to obtain such information and the tapes, if possible. (U)

On 5/12/70, both [REDACTED]

[REDACTED] advised they were unable to locate anyone that had taped GREGORY's speech. (U)

[REDACTED] Baltimore, Maryland, advised the BPD did not tape GREGORY's speech.

2*

~~CONFIDENTIAL~~

~~CONFIDENTIAL~~



UNITED STATES DEPARTMENT OF JUSTICE

FEDERAL BUREAU OF INVESTIGATION

Baltimore, Maryland
May 28, 1970

In Reply, Please Refer to
File No. 157-2722

RE: APPEARANCE OF NATIONALLY KNOWN COMEDIAN
DICK GREGORY AT MORGAN STATE COLLEGE,
BALTIMORE, MARYLAND,
APRIL 9, 1970

On May 21, 1970 BA T-1, a confidential source of this Bureau, who has furnished reliable information in the past, advised The Book Of The Month Club of Morgan State College (MSC), a predominantly Negro college in Baltimore, Maryland sponsored the appearance of nationally known comedian DICK GREGORY on the MSC campus at 1:00 P.M. on April 9, 1970. Approximately 2,500 persons, primarily MSC students, attended. ~~(U)~~

BA T-1 stated that GREGORY spoke for approximately two hours, primarily about America being a sick society.

BA T-1 provided the following as a portion of the statements made by GREGORY: ~~(U)~~

GREGORY said, "For the past two years I have spent most of my time on college campuses talking with you because it's you kids who will have to straighten out this sick degenerate society. It's a sick society that has as a Vice-President a cat as dumb as AGNEW. He is so dumb that he cannot walk and chew gum at the same time. He is so dumb that he is the only cat that went on a panty raid in college and came back with a jockey strap. It's a sick society and you are the ones to straighten it out, but it's too bad that the old fools have used up all the tricks. It's a sick society where the news media prints an article about the bombing of three buildings in New York and names the culprits as the Left. They have named the culprits before the police and authorities have investigated. It was night time, no one was hurt, three buildings damaged and every paper carried the story. Now on the other hand, three hoodlums damn near destroy a whole town in Connecticut robbing a bank; they

CLASS. & EXT. BY 2842 pmv/ELM
REASON-FCIM II, 1-2.4.2
DATE OF I 5-28-70

100-440423-556

ENCLOSURE

GROUP 1
Excluded from automatic
downgrading and
declassification

THIS DOCUMENT CONTAINS NEITHER RECOMMENDATIONS
NOR CONCLUSIONS OF THE FBI. IT IS THE PROPERTY
OF THE FBI AND IS LOANED TO YOUR AGENCY; IT
AND ITS CONTENTS ARE NOT TO BE DISTRIBUTED
OUTSIDE YOUR AGENCY.

~~CONFIDENTIAL~~

~~CONFIDENTIAL~~

RE: APPEARANCE OF NATIONALLY KNOWN COMEDIAN
DICK GREGORY AT MORGAN STATE COLLEGE,
BALTIMORE, MARYLAND,
APRIL 9, 1970

could have killed hundreds of people in a shopping center, but you heard very little about that. It's a sick society. If you break in a house, hit a little old lady beside the head with a brick and take a nickle and get caught, you are really in trouble, but if you break in the same house, hit the same old lady with the same brick and take a million dollars, they would probably say she had no business keeping that kind of money in the house. This is a sick society and the old fools have used up all the tricks. All you need in this country to get out of big trouble is the big buck, a lawyer and plead insanity. Now, don't you go writing a bad check for \$20.00; you are going to jail. You can plead insanity, run up and down the street naked a- chewing razor blades, but you are going to jail for that bad check. You have a big job straightening out this sick society. Now, when the riot season comes again, that's right, they have given us July and August, when the season comes again, I want you to copy, you can do that without reading, copy the Declaration of Independence and sit the old fools in front of the TV and let them watch those niggers looting and tearing up the town; then as loud as you can, read the Declaration of Independence to them, and may be, they, for the first time, will understand what's going on. It's a sick society and you have got a big job straightening it out." U

BA T-1 said there were no incidents either during or after GREGORY's appearance. ~~(U)~~

~~CONFIDENTIAL~~

MAY 1962 EDITION
GSA FPMR (41 CFR) 101-11.6

UNITED STATES GOVERNMENT

Memorandum

TO : DIRECTOR, FBI (100-440423)

DATE: JUL 7 1970

~~CONFIDENTIAL~~

FROM : SAC, CHICAGO (157-347) (P)

APPROPRIATE AGENCIES
AND FIELD OFFICES
ADVISED BY ROUTING
SLIP (S) BY MLK
DATE 12/21/79

SUBJECT: RICHARD CLAXTON GREGORY
RM

Re Chicago airtel and letterhead memorandum (LHM) to the Bureau dated 12/30/69 and Bureau airtel to Baltimore dated 4/15/70 *juw 511*

Enclosed for the Bureau are twelve (12) copies of an LHM captioned and dated as above. One (1) copy each has been furnished to the Office of Special Investigations (OSI), United States Naval Investigative Service Office (NISO), United States Secret Service, United States Attorney, all Chicago, Illinois, and to Region I, 113th Military Intelligence Group, Evanston, Illinois.

b7D

The confidential sources utilized in the enclosed LHM are (CG T-1) [redacted] (PROB) and (CG T-2) [redacted] (PROB).

The enclosed document is classified confidential to protect the identities of sources, who are of continuing value.

RICHARD CLAXTON GREGORY is an Agitator Index (AI) subject and his activities are being constantly followed and will be reported promptly.

CLASS. & EXT. BY 5180 RUB/CLM
REASON-FCIM II, 1-2.4.2 #2
DATE OF REVIEW 7/7/90

EX 106 *Para c otherwise per [unclear]*
REG-87 100-440423-55

- ③ - Bureau (Enc. 12)
 - (1 - 157-) (AAPL)
- 5 - Chicago
 - (1 - A) [redacted] (U)
 - (1 - 157-1821) [redacted]
 - (1 - 157-3109) (AAPL) *off*
 - (1 - 157-5405) [redacted] *su*

REVERSE SIDE FOR JUL 9 1970
DISSEMINATION

b6
b7C
b7D

HHS:cmm AGENCY: ~~ARMY~~ SEC SERV.,
(8) DEPT: ~~ISD, CRE, IDIU, CD~~ -SIDU

HOW FORW: *RS*
DATE FORW: *7/14/70*
BY: *JDP/VLM* *5000*

Recipients notified by r/s of declassification on 7/9/75
JDP/RJA 7/9/75

~~CONFIDENTIAL~~

157-9986-
NEEQ COPY AND COPY OF ENCL FILED IN

CR
ENCC

RACIAL INTL SECT.



UNITED STATES DEPARTMENT OF JUSTICE

FEDERAL BUREAU OF INVESTIGATION

Chicago, Illinois

JUL 7 1970

~~CONFIDENTIAL~~

In Reply, Please Refer to
File No. 157-347

APPROPRIATE AGENCIES
AND FIELD OFFICES
ADVISED BY ROUTING
SLIP(S) BY MLK
DATE 12/21/79

~~CONFIDENTIAL~~

RICHARD CLAXTON GREGORY,
ALSO KNOWN AS DICK GREGORY

All sources utilized in this memorandum have furnished reliable information in the past. u

On June 23, 1970, CG T-1 advised that on the night of June 22, 1970, Richard Claxton Gregory appeared at a benefit for the Afro-American Patrolmen's League (AAPL), entitled "Dick Gregory in Concert". ~~X~~ u

Dick Gregory by profession is a nightclub entertainer (comedian), who in the past has concerned himself with civil rights and social issues, but prefers to be known as "a commentator on affairs - social and political". u

CG T-1 advised that George O'Hare, member Board of Directors, Catholic Interracial Council, Chicago, served as the moderator for the program, which consisted of two phases: u

1. A panel discussion
2. Entertainment

ILL CG T-1 advised that the panel was made up of Father George Clements, a Roman Catholic priest; John Evans, newscaster National Broadcasting Company (NBC), Chicago; u

*Declassified
5-21-75 by 3028
WNV 12/13/79*

~~CONFIDENTIAL~~

CLASS. & EXT. BY 5180 RLB/KLM
REASON-FCIM II, 1-2.4.2 #2
DATE OF REVIEW 7/7/90
per C. Atkinson

~~GROUP 1~~
~~Excluded from automatic~~
~~downgrading and~~
~~declassification~~

This document contains neither recommendations nor conclusions of the Federal Bureau of Investigation (FBI). It is the property of the FBI and is loaned to your agency; it and its contents are not to be distributed outside your agency.

~~CONFIDENTIAL~~

ENCLOSURE

100-440423-557

RICHARD CLAXTON GREGORY,
ALSO KNOWN AS DICK GREGORY

~~CONFIDENTIAL~~

and Renault ^{ILL}Robinson, suspended Chicago policeman and
President of the AAPL. ^u
AERO-AMERICAN PATROLMEN'S LEAGUE

Robinson stated the philosophy of AAPL, which is set forth in the form of a resolution attached hereto, after which he and Father Clements answered questions, submitted by the audience, as read by Evans. ^u

In response to a question Father Clements explained that his interest in the AAPL stemmed from the fact that policemen in most communities serve the people and give the people a sense of security, but this was not the case in the black ghettos of Chicago and the AAPL was the only hope the people of these ghettos have. ^u

The Chicago Police Department had special, negative methods of dealing with ghetto dwellers and it was nonsensical to think that the power structure would consider applying uniform police service to all communities. The AAPL, in its brief existence, had demonstrated that the police could serve those who need the police most, the ghetto dwellers. ^u

Following the panel, Gregory entertained by telling jokes related to current events, especially statements attributed to Vice President Spiro T. Agnew and his humor was well received. ^u

Gregory entertained for approximately 50 minutes, after which he praised Robinson and the AAPL, the Black Panthers (BPP) and the overall youth movement. ^u

A characterization of the Black Panther Party (BPP) is attached. ^u

CG T-1 advised that admissions of \$5.00 and \$10.00 were charged, \$5.00 for balcony seats and \$10.00 for the main floor. Approximately 200 persons were seated in the balcony and 300 on the main floor. Approximately 60% of the audience was Caucasian and in the over 35 age group. ^u

~~CONFIDENTIAL~~

~~CONFIDENTIAL~~

~~CONFIDENTIAL~~

~~CONFIDENTIAL~~

RICHARD CLAXTON GREGORY,
ALSO KNOWN AS DICK GREGORY

CG T-1 advised that a group discussion session followed Gregory's performance and Gregory related that during the period September 19, 1969, and June 20, 1970, he spoke at 320 colleges in every state but Mississippi, at a fee of \$1,000 to \$1,500 per appearance and had an air transportation bill of \$35,000.00. ~~(U)~~ (U)

In addition to the above economic activity, June 29, 1970, Newsweek, a weekly nationally distributed publication, reports Gregory has returned to night clubs "to pay the rent now that school is out".

On March 20, 1970, CG T-2 advised that Gregory's booking agency was American Program Bureau, 59 Temple Place, Boston, Massachusetts. ~~(U)~~ (U)

The following is personal data concerning Dick Gregory:

Residence	1451 East 55th Street Chicago, Illinois
Employment	Comedian, author, lecturer and owner Dick Gregory Products, New York, New York
Marital status	Gregory is married and the father of eight children
Arrest record	Gregory has a record of numerous arrests relating to protest activity and during the summer of 1968 he served 45 days in jail at Olympia, Washington, the result of a conviction for demonstrating in support of fishing rights of the Nisqually Indians. During the summer of 1969 he served 25 days in jail at Chicago, Illinois, the result of a conviction for demonstrating

~~CONFIDENTIAL~~

~~CONFIDENTIAL~~

~~CONFIDENTIAL~~

RICHARD CLAXTON GREGORY,
ALSO KNOWN AS DICK GREGORY

in protest of de facto segregation
in the public school system.

On June 23, 1970, CG T-1 verified Gregory's residence and advised Dick Gregory Products deals in cosmetics for blacks and has been in existence for several years, but was really starting to prosper as Gregory was devoting some of his energies to the promotion. He further advised that 5% of gross income is being donated to the United Negro College Fund at the behest of Gregory. ~~(S)~~ (U)

~~CONFIDENTIAL~~

~~CONFIDENTIAL~~

WHEREAS, the entire black population has a serious interest in improving the quality of life in the black community and

~~CONFIDENTIAL~~

WHEREAS, the historical role between black police officers and the black community has not been a constructive one and

WHEREAS, the time of social and economic crisis in which we live requires that the black community marshal all of its forces in a positive way, and

WHEREAS the black police officers of the AFRO AMERICAN PATROLMEN'S LEAGUE have undertaken the task of improving their performance as police officers to the end that they may exercise their authority with compassion and understanding in order to be of positive benefit to the black community and

WHEREAS the black community is appreciative of this new orientation on the part of black police officers and

WHEREAS black policemen and the black community need to be supportive of each other in order to achieve the desired improvement in the quality of life in black neighborhoods

BE IT RESOLVED:

1. That the AFRO AMERICAN PATROLMEN'S LEAGUE pledge itself to the support of all community efforts devoted to establishing respect for black manhood black womanhood and black pride within the law.
2. That the black community will accept and support the efforts of the AFRO AMERICAN PATROLMEN'S LEAGUE to reverse the distrust and hostility towards black police officers.
3. That the black community and the AFRO AMERICAN PATROLMEN'S LEAGUE dedicate themselves to the proposition that law enforcement may be practiced by black police officers with compassion understanding and efficiency.
4. That the goal of law enforcement officers will become the employment of courtesy and compassion, rather than the mere absence of brutality.
5. That the black community and the black police officers will respect the sanctity of human life whether clothed in a police uniform a prison uniform or civilian dress.
6. That the black community and the black police officers will be mutually supportive of efforts to bring about a new community where unity of purpose and recognition of the nobility of the black heritage will be a deterrent to crime; where moral authority imposed from within will govern human relationships rather than technical legalism; and where those of us who are black will be able to live lives of beautiful fulfillment.

~~CONFIDENTIAL~~

~~CONFIDENTIAL~~

1

APPENDIX

BLACK PANTHER PARTY

According to its official newspaper, the Black Panther Party (BPP) was started during December, 1966, in Oakland, California, to organize black people so they can take control of the life, politics, and the destiny of the black community. It was organized by BOBBY GEORGE SEALE, BPP Chairman, and HUEY P. NEWTON, BPP Minister of Defense. NEWTON is presently serving a sentence of 2 to 15 years on a conviction of manslaughter in connection with the killing of an Oakland police officer.

The official newspaper, "The Black Panther," which further describes itself as the "Black Community News Service," states that the BPP advocates the use of guns and guerrilla tactics in its revolutionary program to end oppression of the black people. Residents of the black community are urged to arm themselves against the police who are consistently referred to in the publication as "pigs" who should be killed.

"The Black Panther" issue of September 7, 1968, contains an editorial by BPP Minister of Education, GEORGE MASON MURRAY, which ends with the following:

"Black men. Black people; colored persons of America, revolt everywhere! Arm yourselves. The only culture worth keeping is a revolutionary culture. Change. Freedom everywhere. Dynamite! Black Power. Use the gun. Kill the pigs everywhere."

Included in the introduction to an article appearing in the October 5, 1968, edition of "The Black Panther" is the statement, ".....we will not dissent from American Government. We will overthrow it."

Issues of "The Black Panther" regularly contain quotations from the writings of Chairman MAO Tse-tung of the People's Republic of China and feature MAO's statement that "political power grows out of the barrel of a gun."

The national headquarters of the BPP is located at 3106 Shattuck Avenue, Berkeley, California. Branches have been established at various locations throughout the United States.

~~CONFIDENTIAL~~

GSA FPMR (41 CFR) 101-11.6

UNITED STATES GOVERNMENT

Memorandum

~~CONFIDENTIAL~~

TO : DIRECTOR, FBI (100-440423)

DATE: 7/28/70

FROM : SAC, CHICAGO (157-347) (P)

SUBJECT: RICHARD CLAXTON GREGORY, aka
RM

Enclosed for the Bureau are 11 copies of an LHM captioned and dated as above. No local dissemination being made as the activities being reported do not involve other agencies within this Division, and could possibly serve to pinpoint this source.

Source is [redacted] Source has been assigned [redacted]

b7D

The enclosed document is classified confidential to protect the identity of the source, who is of continuing value.

Subject is an Agitator Index (AI) subject and his activities are being constantly followed and will be reported promptly.

ENCLOSURE

- 3 - Bureau (Encls. 11) (RM)
- 1 - Chicago
- MHS/lac
- (4)

REC 83 100-440423

558

ST 100

5 JUL 30 1970

APPROPRIATE AGENCIES AND FIELD OFFICES ADVISED BY ROUTING SLIP ON 2-7-80 gub

AGENCY: FBI SI, SEC SERV.,
DEPT: ISD IDIU, CI, IA
STATE DEPT
HOW FORW: RS
DATE FORW: 8/4/70
BY: TJO/VHM 4000

1-16-80
CLASS. BY 2842 P/L/c
EXEMPT FROM FCIM II, 1-2.4.2
DATE OF REVIEW 7-28-90

TD
[Signature]

66 AUG 5 1970

~~CONFIDENTIAL~~



UNITED STATES DEPARTMENT OF JUSTICE
FEDERAL BUREAU OF INVESTIGATION

In Reply, Please Refer to
File No. 157-348

Chicago, Illinois
July 28, 1970

~~CONFIDENTIAL~~

~~CONFIDENTIAL~~

RICHARD CLAXTON GREGORY,
ALSO KNOWN AS DICK GREGORY

On June 29, 1970, a confidential source who has furnished reliable information in the past, advised that Black comedian and civil rights activist, Dick Gregory, planned to attend a "world-wide conference on Black Unity" in Zambia, during August, 1970. Source has been advised that the conference will include Blacks from Africa, South America, and the United States of America and will stress a union of dark peoples of the world. ~~(S)~~ (U)

Source further advised that, according to Gregory, Gregory was invited by Bob Hope to participate in the "Honor America Day" at Washington, D. C., on July 4, 1970, but Gregory wrote a letter to Hope stating he did not feel free to participate in view of the continued enslavement of Black persons throughout the United States. ~~(S)~~ (U)

APPROPRIATE AGENCIES AND FIELD OFFICES
ADVISED BY ROUTING SLIP ON 2-7-80 *gsk*

~~CONFIDENTIAL~~

Group I
Excluded from
Automatic downgrading
and declassification

This document contains neither recommendations nor conclusions of the FBI. It is the property of the FBI and is loaned to your agency; it and its contents are not to be distributed outside of your agency.

1-16-80
CLASS. & EXT. BY 2842 DVN/c
REASON-FCIM II, 1-2.4.2
DATE OF REVIEW 7-28-90

ENCLOSURE

~~CONFIDENTIAL~~

157-440423-558

UNITED STATES GOVERNMENT

Memorandum

TO : DIRECTOR, FBI (157-12382)

DATE: 8/12/70

FROM : SAC, TAMPA (157-3163) (P*)

SUBJECT: RICHARD CLAXTON GREGORY
RM
OO:TP

Re Tampa letter to Bureau 4/29/70.

The July 29, 1970, edition of "The Oracle", University of South Florida newspaper contained an article captioned "Series Signs Gregory, Devlin, and Fulbright."

The article indicates that DICK GREGORY will be one of several individuals to participate in the 1970-1971 Lecture Series at the University of South Florida. He is scheduled for April 13, 1971.

The Tampa Office will afford appropriate coverage when necessary.

ADMINISTRATIVE:

This matter is being placed in a pending inactive status, to be re-opened March 15, 1971 for appropriate handling.

- ② - Bureau
 - 2 - Chicago (157-347)
 - 2 - Tampa
- JWH:ms
(6)

b6
b7c

ALL INFORMATION CONTAINED
HEREIN IS UNCLASSIFIED
DATE 1-16-80 BY 2842/cu

EX-117

REC-73

100-440423-559

AUG 14 1970

RACIAI
ADM. SECT.



341
AUG 21 1970

FBI

~~CONFIDENTIAL~~

Date: 8/14/70

Transmit the following in _____
(Type in plaintext or code)

AIRTEL REGISTERED AIRMAIL

Via _____
(Priority)

TO: DIRECTOR, FBI (100-440423)
FROM: SAC, HONOLULU (157-180) (RUC)
SUBJECT: RICHARD CLAXTON GREGORY, aka
Dick Gregory
RM
(OO: CHICAGO)

Re Honolulu letter to the Bureau dated 4/28/70.

[redacted] Honolulu International Center (HIC) advised that subject is scheduled to appear at the HIC for a one-night performance at 7 p.m., on 8/30/70, only.

On instant date, [redacted] advised that as of this date, GREGORY is scheduled to arrive Honolulu on 8/28/70, and depart on or before 9/1/70, as he had other engagements on the mainland after that date. (U)

[redacted] further advised that GREGORY would stay on Kona, Island of Hawaii, during this brief visit and has not scheduled any speaking engagements in Honolulu. (U)

- 10 - Bureau (RAM)
- 2 - Chicago (RAM)
- 1 - Honolulu

REG/bad
(5)

1-16-80
CLASS. & EXT. BY 2242 PVD/cj
REASON-FCIM II, 1-2.4.2.2
DATE OF REVIEW 8-14-90

APPROPRIATE AGENCIES AND FIELD OFFICES ADVISED BY ROUTING SLIP ON 2-7-80
REC-28
EX-112
100-440423-560

AUG 17 1970

54 AUG 25 1970
Special Agent in Charge

b6
b7C
b7D

b6
b7C

8/24/70

Airtel

~~CONFIDENTIAL~~
[Redacted]

b6
b7C

To: SACs, Chicago (157-347)
New York

From: Director, FBI (100-440423)

RICHARD CLAXTON GREGORY
RM - BN

See

[Redacted] has advised that subject and [Redacted] New York, New York, have made joint application for a visa to visit Australia for a duration of a few weeks beginning 8/28/70. [Redacted] speculated they will attend a Vietnam Moratorium meeting scheduled to be held in Australia 9/18-20/70. ~~(S)~~ (U)

b6
b7C
b7D

Chicago and New York should remain alert for information concerning purpose of this visit, as well as their activities while there. Submit any pertinent information developed in form suitable for dissemination.

CEE:sef

(7)

sef

1-16-80
CLASS. & EXT. BY *2842 PVD/cc*
REASON-FCIM II, 1-2.4.2 *2, 3*
DATE OF REVIEW *8-24-90*

NOTE:

Above information furnished SA Theron D. Rushing on 8/21/70 by [Redacted]

b6
b7C
b7D

APPROPRIATE AGENCIES AND FIELD OFFICES ADVISED BY ROUTING SLIP ON 8-25-70

- Tolson _____
- Sullivan _____
- Mohr _____
- Bishop _____
- Brennan, C.D. _____
- Callahan _____
- Casper _____
- Conrad _____
- Felt _____
- Gale _____
- Rosen _____
- Tavel _____
- Walters _____
- Soyars _____
- Tele. Room _____
- Holmes _____
- Gandy _____

MAILED 4
AUG 24 1970
COMM-FBI

REC-33

ST-120

100 - 440423 - 561

see

Wtk

58 AUG 25 1970
376

19 AUG 25 1970

MAIL ROOM TELETYPE UNIT

~~CONFIDENTIAL~~

~~CONFIDENTIAL~~

8/25/70

RA

Airtel

- 1 - [redacted]
- 1 - Foreign Liaison Desk
- 1 - [redacted]

b6
b7C

To: SACs, Chicago (157-347) ~~NY~~ (U)
 New York
 Legats, London
 Rome

1-16-80
 CLASS. & EXT. BY 2842 PVD/ci
 REASON-FCIM II, 1-2.4.2 2-13
 DATE OF REVIEW 8-25-90

From: Director, FBI (100-440423)

RICHARD CLAXTON GREGORY
RM - BN

See 561

lc

ReBuairtel dated 8/24/70, to Chicago and New York.

[redacted] has advised that subject and [redacted] New York, New York, have made joint application for a visa to visit Australia. They indicated in their travel plans they would leave Honolulu, Hawaii, 8/28/70 and travel to London; Rome; Lusaka, Zambia; and Nairobi, Kenya, arriving at Perth, Australia, 9/13/70 en route to Sydney. The duration of their stay in Australia will be two weeks. ~~(U)~~ (U)

b6
b7C
b7D

Recipients should be alert for information concerning the purpose of their travel, as well as their activities while abroad. Submit any pertinent information developed in form suitable for dissemination. ~~(U)~~ (U)

REC 14 100-440423-562

CEE:sef
(13) *sef*

MAILED 22
 AUG 25 1970
 COMM-FBI

EX-110

19 AUG 26 1970

NOTE:

We were previously advised by [redacted] of subject's contemplated travel to Australia. Details of travel were furnished SA Theron D. Rushing on 8/24/70 by [redacted]

b6
b7C
b7D

- Tolson _____
- Sullivan _____
- Mohr _____
- Bishop _____
- Brennan, C.D. _____
- Callahan _____
- Casper _____
- Conrad _____
- Felt _____
- Gale _____
- Rosen _____
- Tavel _____
- Walters _____
- Soyars _____
- Tele. Room _____
- Holmes _____

MAIL ROOM

516
58 AUG 29 1970

JAS/ [signature] WKE

~~CONFIDENTIAL~~

F B I

Date: 9/3/70

CDB/A

Transmit the following in _____
(Type in plaintext or code)

Via AIRTEL _____
(Priority)

TO: DIRECTOR, FBI (100-440423)
FROM: SAC, CHARLOTTE (157-5865) (P)

APPEARANCE OF RICHARD CLAXTON GREGORY,
GUILFORD COLLEGE, GREENSBORO, N. C.,
10/8/70
RM

(OO: CHICAGO)

On 9/1/70, Lt. _____

_____ advised that he had learned DICK GREGORY was going to appear at Guilford College, 10/8/70 as part of the Fine Arts Program sponsored by the Student Union of the college. Charlotte will alert appropriate authorities and arrange coverage of GREGORY's appearance and furnish pertinent information developed, inclusive of transcript of remarks if tape recordings available, in form suitable for dissemination.

2-Bureau (RM)
2-Chicago (157-347) (RM)
2-Charlotte
GHC:mjb
(6)

ALL INFORMATION CONTAINED
HEREIN IS UNCLASSIFIED
DATE 1-16-80 BY 2842/UC

EX-109
REC-84

100-440433-364

4 SEP 7 1970

Approved: _____ Sent _____ M Per _____

Special Agent in Charge

55 SEP 15 1970

F72

b6
b7c

b6
b7c

EX 106

September 14, 1970

REC-88 100-440423-565

Honorable Jerome R. Waldie
House of Representatives
Washington, D. C. 20515

My dear Congressman:

I have received your letter of September 10th enclosing a copy of a communication from [redacted] [redacted] California.

b6
b7C

[redacted] sent me a copy of his letter to you, to which I responded on September 11th. I am enclosing a copy of my letter to him for your information.

With respect to the basis for your constituent's comments, Dick Gregory is a liar. As explained in my letter to [redacted], the FBI has no jurisdiction over narcotics violations and Gregory knows this; however, he persists in using this lie in statements he has made.

Sincerely yours,

J. Edgar Hoover

MAILED 5
SEP 14 1970
COMM-FBI

✓

NOTE: Bufiles disclose prior limited correspondence with Congressman Waldie (D-California) concerning constituent matters. No record of [redacted] identifiable except in connection with the copy of his letter to the Congressman mentioned above which was received 9-8-70 and answered 9-10-70.

b6
b7C

JBT:mrm (4)

mrm

- Tolson _____
- Sullivan _____
- Mohr _____
- Bishop _____
- Brennan, C.D. _____
- Callahan _____
- Casper _____
- Conrad _____
- Felt _____
- Gale _____
- Rosen _____
- Tavel _____
- Walters _____
- Woyars _____
- Tele. Room _____
- Holmes _____
- Gandy _____

Felt

[redacted]

Waldie
a

TEB

[redacted]

4718

MAIL ROOM TELETYPE UNIT

Q

JEROME R. WALDIE
MEMBER OF CONGRESS
14th District, CALIFORNIA

WASHINGTON ADDRESS:
Room 408
CANNON HOUSE OFFICE BUILDING
WASHINGTON, D.C. 20515
PHONE: 225-5511
AREA CODE: 202

Congress of the United States
House of Representatives
Washington, D.C. 20515

Mr. Tolson	<input checked="" type="checkbox"/>
Mr. Sullivan	<input checked="" type="checkbox"/>
Mr. Mohr	<input checked="" type="checkbox"/>
Mr. Bishop	<input checked="" type="checkbox"/>
Mr. Brennan, C.D.	<input checked="" type="checkbox"/>
Mr. Callahan	<input type="checkbox"/>
Mr. Casper	<input type="checkbox"/>
Mr. Conrad	<input type="checkbox"/>
Mr. Felt	<input type="checkbox"/>
Mr. Gale	<input type="checkbox"/>
Mr. Rosen	<input type="checkbox"/>
Mr. Tavel	<input type="checkbox"/>
Mr. Walters	<input type="checkbox"/>
Mr. Soyars	<input type="checkbox"/>
Tele. Room	<input type="checkbox"/>
Miss Holmes	<input type="checkbox"/>
Miss Gandy	<input type="checkbox"/>

VICE
ME

September 10, 1970

Hon. J. Edgar Hoover, Director
Federal Bureau of Investigation
Department of Justice
Washington, D.C.

Dear Mr. Hoover:

Dick Gregory

Enclosed is a copy of a letter I have received
from [redacted]
California, concerning the ease with which nine year
olds can locate drug peddlers.

May I have your comments on [redacted]
letter?

Sincerely yours,

Jerome R. Waldie

JEROME R. WALDIE
United States Congressman
Fourteenth District

EX 106

REC-88 100-440473-565

*Call him Gregory is
a liar. FBI has no
jurisdiction over narcotics
& Gregory knows it but
pretends to use the
K O*

15 SEP 11 1970

CORRESPONDENCE

EXP. PROC.

b6
b7c

30 SEP 11 1970

Waldie

SEP 11 1970

JRW:mrr

*ack
9-14-70
BT/mm
ENCLOSURE
mml-2*

dw

30

September 3, 1970

The Honorable Jerome Waldie
Room 408 --
Cannon House Office Building
Washington, D.C.
20515

My dear Mr. Waldie:

A question has plagued me since seeing Mr. Dick Gregory on the David Frost Show, i.e., how can nine year olds find drug peddlers, dope pushers, etc., when the FBI or police can't? Either we have underestimated our youth or overestimated the FBI.

I am sure the above is simplification of the problems involved; nevertheless, it is still very puzzling. Another fact bothers me, i.e., why have I only been able to get information on left wing militant organizations being raided when I have read reports on right wing militant organizations and have never heard of any raids?

Any light you can shed on the above subject would be appreciated.

cc: Hon. Richard Nixon
Hon. Spiro Agnew
Hon. Alan Cranston
Hon. J. Edgar Hoover

100-440473-565

- Tolson _____
- Sullivan _____
- Mohr _____
- Bishop _____
- Brennan, C.D. _____
- Callahan _____
- Casper _____
- Conrad _____
- Felt _____
- Gale _____
- Rosen _____
- Tavel _____
- Walters _____
- Soyars _____
- Tele. Room _____
- Holmes _____
- Gandy _____

B-1 Drug Foes Stage Protests

By Aaron Latham
and B. D. Colen

Washington Post Staff Writers

Marion Barry violated District laws three times yesterday by leading about 80 demonstrators to the doorsteps of three foreign embassies, then capped the day with a meeting with State Department officials.

The demonstrations and the meeting had a common goal: Bringing to an end the flow of illegal narcotics into the United States.

Barry and the demonstrators, some of whom are employees of Pride, Inc., the community self-help organization that he heads, broke a District of Columbia law that bans demonstrations within 500 feet of an embassy.

The demonstrators were threatened with arrest when they massed in front of the embassies of France, Turkey and Italy. They disbanded each time police told them to do so, but not before Barry told the police that "everybody has a right to picket where he wants, so long as he is orderly."

The demonstrators blame Turkey for allowing opium-producing poppies to be grown; France for allowing opium to be processed into heroin within its borders, and Italy for allowing the Mafia to direct international drug traffic.

The State Department was picked as a target because the demonstrators feel that the government is not doing enough to stop the flow of illegal drugs, and is maintaining

friendly relations with the countries producing the narcotics that come to this country:

Julius Hobson, the Rev. David Eaton, the Rev. Walter Fauntroy, Reginald Booker, chairman of the Emergency Committee on the Transportation Crisis and Barry spoke at the evening State Department rally.

Hobson, a former school board member, complained that "the FBI can come into my office and find my typewriter ribbon that I've hidden, but they can't find shiploads of drugs."

The group met with Deputy Assistant Secretary of State for Public Affairs William Blair, special assistant to the Assistant Secretary, Edward Blakely, and Harvey Weiman, special assistant to the Secretary of State for narcotics.

After emerging from the State Department after the meeting, Barry said the session accomplished nothing.

Earlier in the day, in front of the Turkish Embassy, the demonstration was forced to take a comic detour.

When the demonstrators were told by police to move on, they asked if they could demonstrate against Turkey in front of the nearby South Vietnamese Embassy. They were told that they could.

So the line of demonstrators filed over to the surprised Vietnamese diplomatic headquarters at 2251 R St. NW, across Sheridan Circle from the Turks, and took up their chant of, "One, two, three, four, Turkish drugs must go."

Last Nov. 14 police and peace demonstrators clashed when marchers wanted to protest in front of the South Vietnamese Embassy. But yesterday's demonstration in front of that embassy saw police blessing

DICK GREGORY
Hobson is just like Gregory. They both know the FBI has no jurisdiction as to narcotics!

- The Washington Post Times Herald B-1
- The Washington Daily News _____
- The Evening Star (Washington) _____
- The Sunday Star (Washington) _____
- Daily News (New York) _____
- Sunday News (New York) _____
- New York Post _____
- The New York Times _____
- The Sun (Baltimore) _____
- The Daily World _____
- The New Leader _____
- The Wall Street Journal _____
- The National Observer _____
- People's World _____
- Examiner (Washington) _____

100-440423

NOT RECORDED
91 SEP 16 1970

SEP 15 1970 Date: SEP 10 1970

ORIGINAL FILED IN 12-0-773

F. G. H.
56 SEP 17 1970

COPY MADE FOR MR. TOLSON

One protester said it was like "Catch-22": "You can only demonstrate in front of the South Vietnamese Embassy if you are protesting against Turkey."

The protesters began their demonstrations in front of the French Embassy, at 2535 Belmont Rd. NW, at about 12:30 p.m.

Only a handful of police were originally on the scene. But when Barry and the others defied the 500-foot limit, the police massed in force.

A large contingent of civil disturbance unit members under the direction of Deputy Chief Owen Davis arrived, along with a long column of police cars and a stream of motor scooter officers.

Police brought along a bus for transporting prisoners and said they planned to begin making arrests. But as they moved in the demonstrators filed onto their own six buses. The protesters, who had been at the French Embassy for more than an hour, headed for the Turkish Embassy.

In front of the embassy, a policeman tore up a demonstrator's sign that read, "Bust pushers and distributors by

any means necessary." After consulting with police, the demonstrators moved to the South Vietnamese Embassy.

An hour later, the antidrug protesters transferred their demonstration to the Italian Embassy, at 1601 Fuller St. NW, where they were again threatened with arrest and again dispersed.

The antidrug demonstration was planned as a part of a week of activities marking Pride's third anniversary.

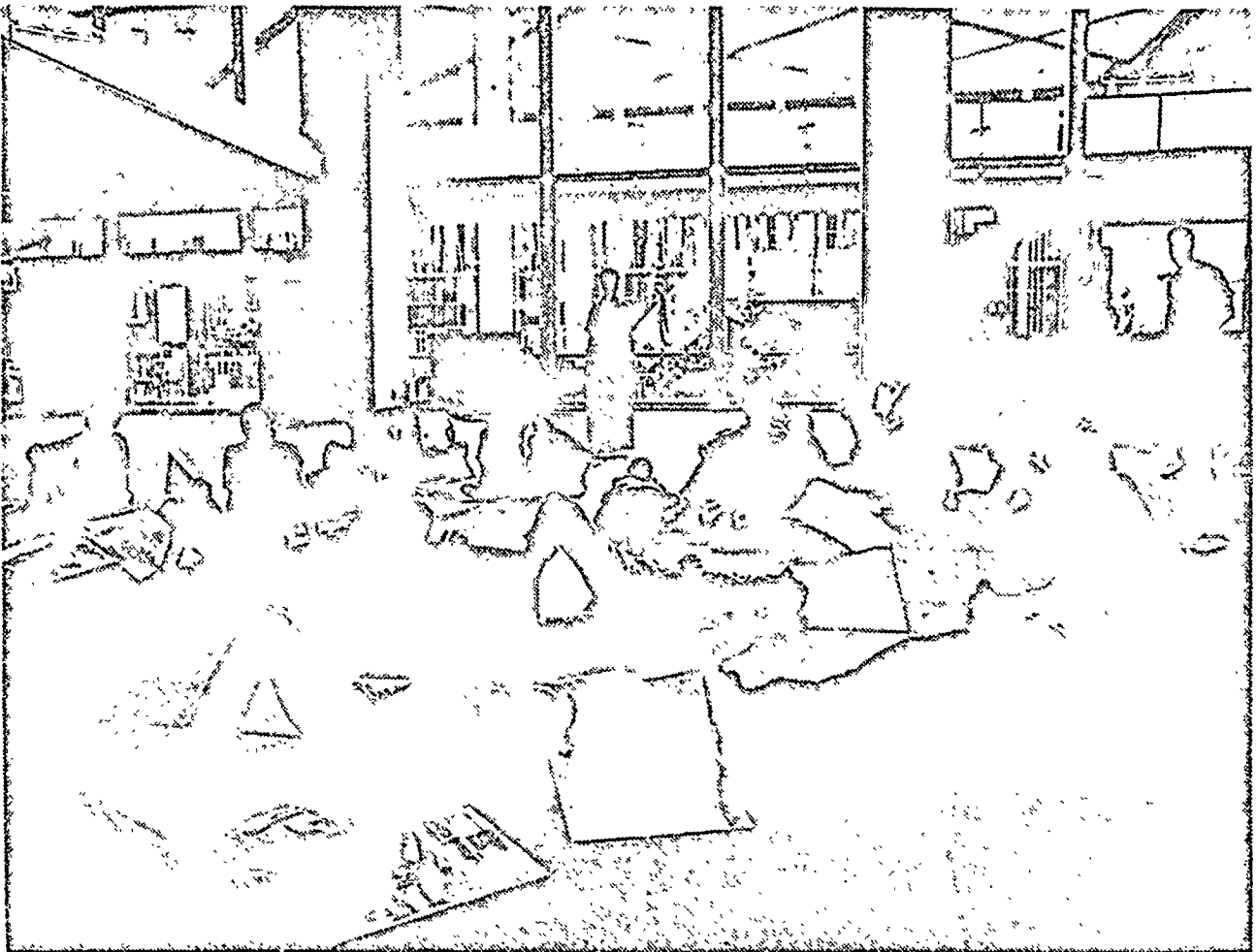

by Gerald Martineau—The Washington Post

Antidrug demonstrators loll outside the State Department as leaders conferred with U.S. officials in the building.

~~CONFIDENTIAL~~

DIRECTOR, FBI

8/31/70

[Redacted] (U)

(U) [Redacted]

BUFILE [Redacted] (U)
OTFILE [Redacted]
OO

b6
b7C
b7D

RICHARD CLAYTON GREGORY, aka
FI
BUFILE 100-421433
OTFILE 157-14 (U)
OO

APPROPRIATE AGENCIES AND FIELD OFFICES
ADVISED BY ROUTING SLIP ON 2-7-80 *at*

[Redacted]

BUFILE [Redacted]
OTFILE [Redacted]
OO Chicago [Redacted]

1-17-80
CLASS. & EXT. BY 2842 p/c
REASON: FCIM II, 1-2.4.2
DATE OF REVIEW 8-31-00 3020

b6
b7C
b7D

Enclosed for information are three copies each of self-explanatory [Redacted] classified CONFIDENTIAL, with attachment thereto. Also instructions re dissemination in para two of enclosed let. (U)

Any additional information re proposed visits received from [Redacted] will be reported. (U)

CONFIDENTIAL FILED IN

- 3 - Bureau (Exec. C)
 - (1 - Foreign Liaison Dept) (direct)
 - (1 - Chicago) [Redacted]
 - (1 - [Redacted]) (OO [Redacted])
 - (1 - [Redacted]) (OO-Category)

(U)

3 - [Redacted]
BUFILE
(11)

NOTED
SEP 8 1970

b6
b7C
b7D

59 SEP 16 1970

~~CONFIDENTIAL~~

Dr. Benjamin Spock, Dick Gregory,
and William Kunstler featured in
fall speaking series at Regina Campus

The Students' Union of the University of Saskatchewan's speaking series this fall will feature three speakers who will appear on alternate dates: Dr. Benjamin Spock, Dick Gregory and William Kunstler.

Dr. Spock will speak in Regina October 27, Dick Gregory on February 23 and William Kunstler on March 22.

All speakers will appear in the evening and will spend a day on campus meeting with small groups of students.

At press time topics had been finalized for two speakers. Dr. Spock will speak on "Dissent in Our Society" and Dick Gregory will speak on "Civil Rights."

Dr. Spock, the famous baby doctor, who wrote "Baby and Child Care" has a long history of work in the fields of pediatrics and child psychology and

has written several books and articles that deal with his profession.

The book Baby and Child Care has sold 22,000,000 copies and is an indication of the number of children raised according to Dr. Spock's method.

It would appear at first glance that Mr. Spock should be well qualified to speak about dissent in our society when presumably a large number of Spock-reared children are dissenters themselves.

In 1962 Dr. Spock joined the National Committee for a Sane Nuclear Policy and was co-chairman until 1967 when he became co-chairman of the National Conference for New Politics.

In January of 1968, Dr. Spock along with four other men was convicted of conspiring to counsel young men to avoid the draft. In a subsequent trial Dr. Spock and the others were found guilty. The case was reversed on appeal. And Dr. Spock is currently speaking nationwide on behalf of the Civil Liberation Legal Defence Fund, Inc., an organization which raises funds to provide for the legal defence of conscientious resisters throughout the country.

Dr. Spock has voiced his opposition to the Vietnam war and made public appearances where he has criticized the Nixon administration and appealed to youth to use legal polite means to put their case and stated that in the event that no action is forthcoming "then an increase in dissent and militant action is certainly justified."

He said that "every aspect social in the United States — ranging from the rights of blacks to improved education and medical care — justifies such an increase."

Finally Dr. Spock says he disbelieves in violence because "in the great majority of cases it works to the advantage of those against whom it is being used."

Long-time civil rights activist and leading entertainer Dick Gregory is well equipped to speak on the question of civil rights.

Gregory was one of the first big name black entertainers to get active in the civil rights movement in the sixties, risking his career as he did so.

Since that time, many early civil rights headlines have backed away from the struggle of black people as it has intensified, becoming necessarily more militant, and as the repressive acts of the authorities have become more violent. Gregory has hung tough.

A very witty man, Gregory uses humor as a weapon in the fight for human dignity. His sardonic humor often cuts through the confusion surrounding a question and lays bare the real situation.

Kunstler, chief defence lawyer for the Chicago 7 conspiracy trial, makes the claim that he has been radicalized through the process of the trial. He has spoken to many audiences in the U.S. and usually he enters giving the symbolic clenched fist salute.

He addresses the audience with a description of the Chicago trial and events surrounding it. He says that the government will not yield to conventional protest. Maybe, he says, "It's time to turn to another type of protest."

He says that we must build up a resistance to the shocking events of the repressive acts of the U.S. state apparatus.

In his address to the public Kunstler describes the U.S. as having a prevailing attitude that compares to the attitude of German people prior to WWII.

He said that we have given our tacit approval to the repressive acts which the government allows.

He said the only difference between America today and pre-war Germany is that "We still have the will to resist. We still have the power to resist."

Kunstler says that we are at a unique period in history, "young people have had a taste of power which has been real and significant and it must not be allowed to dissipate. He voiced his concern that stu-

dents remain together in their thoughts and actions so that this power is not lost."

When William Kunstler addressed a meeting in Toronto the far-right Edmund Burke society showed up to harass him, at this time Kunstler broke off from his prepared speech and decided to speak to the events in the hall.

It should make for an interesting evening in Regina especially with the recent actions of the responsible citizens committee and the uneasy atmosphere of the Chamber of Commerce and business community with their paranoia about youth revolt in Regina.

100-440423 -
ENCLOSURE

Dr. Benjamin Spock, Dick
Gregory and William
Kunstler to speak on
Regina Campus this fall



DR. BENJAMIN SPOCK



DICK GREGORY



WILLIAM KUNSTLER

(See Story Page 3)

FBI

Date: 9/10/70

~~CONFIDENTIAL~~

Transmit the following in _____
(Type in plaintext or code)

AIRTEL

Via _____
(Priority) APPROPRIATE AGENCIES AND FIELD OFFICES
ADVISED BY ROUTING SLIP ON 2-7-80 *per*

TO : DIRECTOR, FBI (100-440423)

FROM : LEGAT, LONDON (157-99) (P) (U)

SUBJECT: RICHARD CLAXTON GREGORY
RM - BN.

REC 83

ReBuairtel 8/25/70.

CLASS. & EXT. BY 2842 PVD/ci
REASON-FCIM II, 1-2.4.2 2,3
DATE OF REVIEW 9-10-90

On _____
_____ (conceal identity),
advised, that _____

b6
b7C
b7D

_____ (U)

_____ GREGORY holds U.S. Passport K761916. (U)

Any further info coming to the attention of this office will be promptly furnished the Bureau.

- 4 - Bureau
 - 1 - Foreign Liaison
 - 1 - London
- ACM:ejg
(6)

REC 83

100-440423-566

SEP 18 1970

ST-113

2cc to Chicago by RS on 9/14/70 for info.
1681 mem

b6
b7C

Approved: _____
Special Agent in Charge

Sent _____ M

~~CONFIDENTIAL~~

100-8360

GSA GEN. REG. NO. 27

UNITED STATES GOVERNMENT

Memorandum

NO yellow

~~CONFIDENTIAL~~

TO : DIRECTOR, FBI

DATE: 9/14/70

FROM : *W* NEGAT, HONG KONG (100-227) (RUC) ~~(U)~~ (U)

SUBJECT: RICHARD CLAXTON GREGORY
RM - BN

ReBuairtel 8/25/70. *juw 562*

Enclosed for the Bureau are five copies of a letterhead memorandum prepared on 9/14/70, incorporating information appearing in the 9/8/70 edition of the "South China Morning Post", daily newspaper published in Hong Kong.

34

APPROPRIATE AGENCIES AND FIELD OFFICES ADVISED BY ROUTING SLIP ON 2-7-80 *mb*

(U) *10* 5 - Bu (Encs. *5*) ENCLOSURE
(1-Foreign Liaison Desk)
(2-Chicago)
1 - HON
JSL:ec
(6)

1-16-80
CLASS. & EXT. BY 2842 p/m/c
REASON-FCIM II, 1-2.4.2 2, 3
DATE OF REVIEW 9-14-90

2cc of let & LHM to Chicago on 9/28/70 for info. CEF/vlm

REC 18 - 100-440423-567
ST-113
22 SEP 22 1970

b6
b7c



320
4 OCT 5 1970

~~CONFIDENTIAL~~



UNITED STATES DEPARTMENT OF JUSTICE
FEDERAL BUREAU OF INVESTIGATION

WASHINGTON, D.C. 20535

September 14, 1970

In Reply, Please Refer to
File No.

~~CONFIDENTIAL~~

RICHARD CLAXTON GREGORY

An article appearing in the September 8, 1970, edition of the "South China Morning Post", English-language daily newspaper published in Hong Kong, reported that American entertainer Dick Gregory had been denied entry into Australia because his application was not bonafide and was "spurious in intent", in the view of Australian Immigration Minister, Mr. Philip Lynch. ~~(S)~~ (U)

According to the article, Gregory had indicated the purpose of his visit to Australia was for "sightseeing". Immigration Minister Lynch, in denying an entry visa to Gregory, expressed the opinion that it was not in the Australian national interest to grant entry to persons seeking to participate in a "one-sided and distorted anti-war campaign inimical to Australian troops in Vietnam". ~~(S)~~ (U)

APPROPRIATE AGENCIES AND FIELD OFFICES
ADVISED BY ROUTING SLIP ON 8-2-80

1-16-80
CLASS. & EXT. BY 9842 pld/ci
REASON-FCIM II, 1-2.4.2 2,3
DATE OF REVIEW 9-14-90

PROPERTY OF THE FBI
This report is loaned to
you by the FBI, and neither
it nor its contents are to
be distributed outside the
agency to which loaned,

~~CONFIDENTIAL~~

ENCLOSURE 100-440423-367

F-44^e



100-440423-569

ENCLOSURE,

Controversy mounts over Gregory case

VISA BAN ON US CLERIC

Labor moves urgency motion in Senate

The Australian Government has refused an entry visa to an American Baptist minister who was to have accompanied Mr Dick Gregory to Australia.

Rev. Foreign

He is Mr James Robert McGraw, president of the Columbia Baptist Church in New York.

PROTEST

A spokesman for the Department of Immigration said Mr McGraw had been refused a visa "for the same reason as applied to Mr Gregory."

The Minister for Immigration, Mr Lynch, said on Wednesday that Mr Gregory had intended to come to Australia to take part in the "one-sided, distorted" Vietnam Moratorium, which was inimical to the objects for which Australian troops were fighting.

The disclosure that Mr McGraw had been refused a visa came in a day of increasing controversy over the Gregory case during which:

Five Sydney barristers and a publisher have signed in a letter to the Editor of the "Herald" against the Government's refusal of a visa to Dick Gregory. They say they support Government policy in Vietnam, but can see no reason to exclude Mr Gregory.

The writers, who have not signed in their official capacity, are Professor David Armstrong, Mr Harry Eddy, Mr Elwyn Lynn and Mr David Stove (Sydney University), Professor Owen Harries (University of NSW), Mr Kenneth Gee (barrister) and Mr Richard Argyier (publisher of the magazine Quadrant and secretary of the Australian Association for Cultural Freedom). Letters: Page 2.

Labor moved an urgency motion in the Senate and accused the Government of abusing its powers to deny freedom of speech in Australia.

Mr Lynch told the House of Representatives the Vietnam Moratorium Campaign was a distorted and one-eyed campaign with little relation to the truth.

The Minister for External Affairs, Mr McMahon, said supporters of the Moratorium in the House were favouring a regime which had committed ruthless murders.

The Premier, Mr Askin, said he would protest to the Prime Minister, Mr Gorton, against Labor MP Dr J. F. Cairns' invitation of North Vietnamese representatives to Australia for Moratorium demonstrations.

During the Senate debate, the Leader of the Opposition, Senator L. K. Murphy, accused Government senators of racism.

Senator Dame Annabelle Rankin replied: "The Leader of the Opposition tried to tell the people of Australia that the reason we had refused this man (Mr Gregory) was because he was coloured."

"But Mr McGraw is a white man." The motion was defeated. The NSW Moratorium

convenor, Mr K. McLeod, said in Sydney, Mr Lynch's phrase "one-eyed" was more applicable to the Government.

LONDON, Thursday. — Mr Gregory today accused the US Government of bringing pressure to bear on the Australian Government to refuse him a visa.

Speaking at his London hotel, he said he had formed this opinion after visiting Australia House yesterday.

"I went there to find out why I had been refused a visa and they showed me a cable from Australia which said the refusal had been because of my anti-Vietnam views," he said.

"And if Australia will be dictated to from a country that is supposed to be the home of freedom then I'd like to know who is the comedian — the Australian Government or me."

Mr Gregory said a visa agency in the US had arranged visas for himself and Mr McGraw, a close friend.

"There was no fallacy on the visas; the agency had marked the purpose of our visit 'for sightseeing purposes' and all the visas as a formality," Mr Gregory said.

PAGE 8: Senate debate, PAGE 11: Protest by Askin.

Mr Gregory leaves Australia House in London on Wednesday after discussing the visa refusal.

SYDNEY MORNING HERALD
4 SEPTEMBER 1970



Danger, funnyman at work

ISOBEL WOOD ON THE DICK GREGORY CASE

IT HAS been some time since the Commonwealth Government showed up in its people-banning mood.

Books, yes; films, yes — but the last intending visitor to have the boom lowered against him was Dr Ernest Mandel, way back in May. Dr Mandel, a Belgian scholar and Marxist, was to have attended a socialist scholars' conference in Sydney. The Australian embassy in Brussels refused him a visa.

A long history of bans and obstructions to would-be visitors holding liberal views preceded the snub to Dr Mandel. (For quite other reasons there was some doubt as to whether Mick Jagger would get in under the wire to make the film *Ned Kelly*.)

The inexplicable admission to Australia of Andrew Pulley, the young anti-Vietnam war Negro soldier brought here on a speaking tour by Resistance, a youth organisation, may have been simply a case of ministerial absent mindedness.

The trouble with Dick Gregory, from the Government's point of view, is that he is a big attraction, a tremendous crowd-pleaser in his days as an entertainer and equally so since he gave up his career and went over entirely to Negro civil rights.

In other words, he sways crowds, a black crowd-swayer at the Vietnam Moratorium would be low on the Government's list of desirable visitors.

Gregory was originally invited to Australia by the Reverend Ted Noffs of Sydney's Wayside Chapel. Having been told so often on his last visit to the U.S. that Australia was racist, Mr Noffs hoped that when Gregory got here and received a warm, friendly reception he would spread the word that although the country was white, it was also great. So much for that intention.

Richard Claxton Gregory is 38. He was born in St Louis and grew up in a home so poor he went to it "only when all other places were closed." He climbed up out of slum poverty via athletics, though his original idea in getting on the high school track team was a desire to use the shower, which was missing at home. His best distance was the mile.

His first engagement as an entertainer was at the Esquire Show Lounge in Chicago for \$30 a three 12-hour nights work. On the strength of a few weeks there he borrowed some money and re-opened what had once been a working-class night club. The only performers he paid the first week were the boys in the band.

"It's impossible to be in the nightclub business six months and not make a penny," he wrote in his autobiography, *Nigger*. "Absolutely impossible. I'll never believe it happened to me."

His success as a night club entertainer began in 1961 when he stood in for a sick comic at the Playboy Club in Chicago and opened up with "Good evening, ladies and gentlemen. I understand there are a good many southerners in the room tonight. I know the South very well. I spent 20 years there one night . . ."

With money and fame assured Gregory began doing benefit shows for Negro civil rights, which led him into speaking for the cause.

Doing as well as talking, he went to Greenwood, Mississippi, for a Negro voter registration drive: "I was scared

to death. Making speeches, giving money, even going down South for a night or two with food — that was one thing. But getting out on those streets and marching against those bullets and dogs and hoses and cattle prods . . ."

In 1968 he led a march of 5000 demonstrators at the Democratic convention in Chicago. They were intercepted by troops of the Illinois National Guard and forced away by a barrage of tear-gas. Gregory was arrested with several of the 25 Democratic Party delegates who had joined the march.

The deprivations of American Indians, inept and hypocritical handling of the narcotics problem, the integration of schools, the high ratio of Negroes in the armed forces — all were subjects for his protest.

While the inheritors of Martin Luther King's programme are unable to break completely out of their formula of respectability, and the exponents of black power veer wildly towards civil war, Gregory manages to remain a stubbornly middle-of-the-road man. So all areas of the movement need him. He is the dynamic presence who comes on with comic bitterness and sarcasm between the gospel-singers and the Panthers.

Gregory went to gaol for the first time in Birmingham, Alabama, when he joined a Martin Luther King demonstration and was picked up with 800 other King supporters. And received his first bad beating: "End to end, up and down, they didn't miss a spot," he wrote.

Civil rights was, by 1963, taking up almost as much of his time as nightclub performances and comedy routine recording. But his comic stock was high enough so that he could always get an engagement.

Because of his visceral style, tough, cynical and bold, a critic called him the black Mort Sahl. "In the Congo," Gregory commented, "they call Sahl the white Dick Gregory."

In 1964 he walked off the job at Basin Street East, New York, when the manager asked him to soften his racial and political patter. "Bad as I need that \$5000 a week," he said, "I'm going fishing instead."

Gregory was to have arrived in Australia on Sunday week, September 13, to stay until September 23. He was to have been principal speaker, with John Kaputin from New Guinea, at the Vietnam Moratorium rally in Sydney on September 18, and to spend a day each in Victoria, WA, and SA.

His next stop after Australia was to be Zambia, where a 67-nation conference is being held early in October to discuss white attitudes to the Negro.

Dr Jim Cairns reported recently that he had hoped the celebrated author and civil liberties proponent Norman Mailer would come to Australia for the Moratorium rally in Melbourne. Mailer's agents could not help Dr Cairns, and the author himself was unavailable either to accept or reject the invitation.

Perhaps it was just as well. He too might have found himself on the undesirable aliens list.

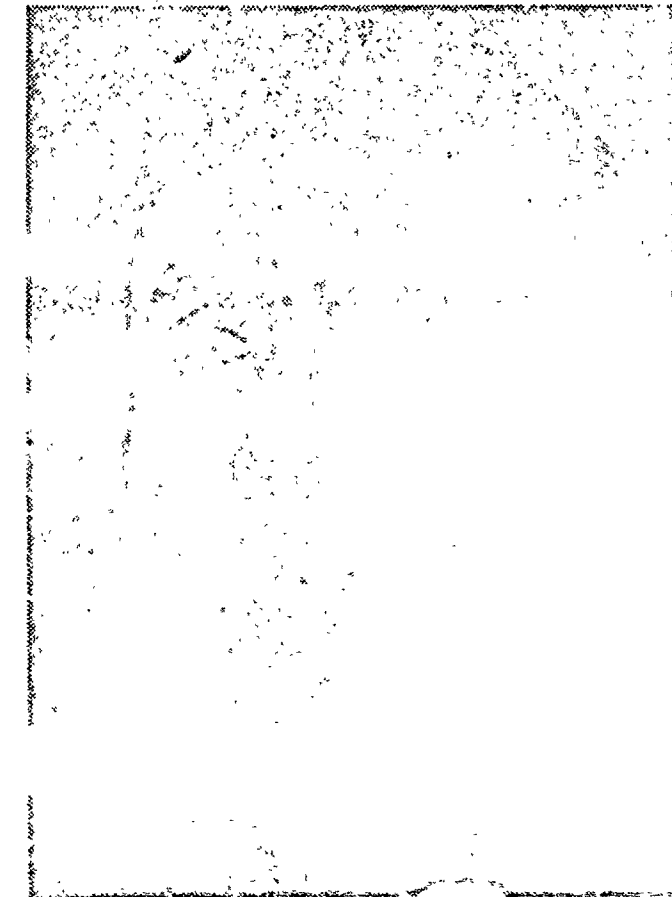

DICK GREGORY: Visa refused, Moratorium defused

of the Australian
3 Sept 70

VISIT WOULD BE 'BETRAYAL OF AUSTRALIAN SERVICEMEN'

LYNCH DEFENDS VISA BAN

Gregory is threat to the nation, he claims

By KENNETH RANDALL

The American Negro comedian and anti-Vietnam campaigner Dick Gregory had been refused entry to Australia because his visit would have been a threat to the maintenance of law and order, the Minister for Immigration, Mr Lynch, told Parliament yesterday.

To allow such a visit, he said, would be a betrayal of Australian servicemen in Vietnam and damaging to their morale.

Mr Lynch's statement made the Gregory case the Government's first positive blow in the "law and order" campaign being pressed strongly by Liberal and Country Party members.

But a serious embarrassment arose in the campaign yesterday with the announcement that Mr John Kaputin, the most prominent leader of the militant Mataungan Association in New Guinea, would make an Australia-wide tour in support of the Vietnam moratorium on September 18.

Mr Lynch was questioned in Parliament yesterday by the Leader of the Opposition, Mr Whitlam. Mr Lynch said the Government's policy was to allow the maximum freedom of travel to Australia.

People were not prevented from entering just because their political views differed from those of the Government.

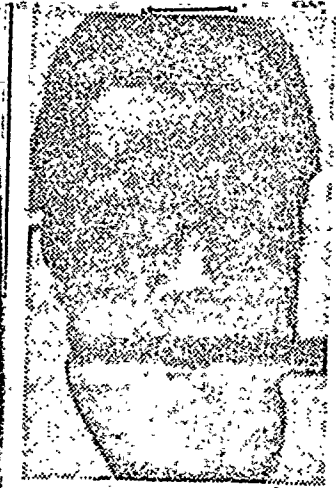

MR KAPUTIN

BAN

REASON 'SPURIOUS'

Gregory's application for a visa covering the period of the Vietnam moratorium campaign had been for the "stated purpose of sightseeing."

In view of recent Press publicity it must be obvious that the stated reason was spurious, Mr Lynch said.

"This Government is not prepared to allow the entry to Australia of persons whose activities are stated to be contrary to the national interest and where their stated purpose in visiting Australia is not judged to be bona fide.

"In the Government's view this applies where the intentions are related to a one-sided, distorted anti-war moratorium campaign inimical to the objects for which Australian troops are fighting in Vietnam.

THE AUSTRALIAN
3 SEPTEMBER 1970

"If authority were given by this Government to persons seeking to enter Australia for this purpose that would, in the view of this Government, have the following effects:

"It would represent a betrayal of Australian servicemen in Vietnam. It would damage the morale of Australian servicemen in Vietnam.

"And thirdly, it would give encouragement to those who seek not peace but peaceful submission, to those who seek to promote the rule of the streets and the power of the mob with the subsequent threat that that involves to the maintenance of law and order in this country."

For these reasons the Government had refused Gregory a visa.

Mr Whitlam said the Government's action would react against Australia through damaging, world-wide publicity.

The moratorium-convenor, Mr K. McLeod, said Gregory had assured him he still intended to try to enter Australia after a conference next week of 67 non-aligned African nations in Zambia.

He would renew his visa application meanwhile but would make the attempt irrespective of the results.

Aquarius, the national student group which arranged for Gregory to tour Australia, accused the Federal Government of confusion over the group's motives.

The group said it intended that Gregory should tour university campuses to stage performances of comedy and social satire — not to take part in political or anti-war rallies.

Mr Kaputin will arrive in Sydney on September 12 or 13 for three weeks to speak at meetings in all States, including the main moratorium rallies in Sydney and Melbourne.

The Mataungan Association's record of civil disobedience raises the law and order issue more obviously than the Gregory case. But the Government is unlikely to stop Mr Kaputin's visit.

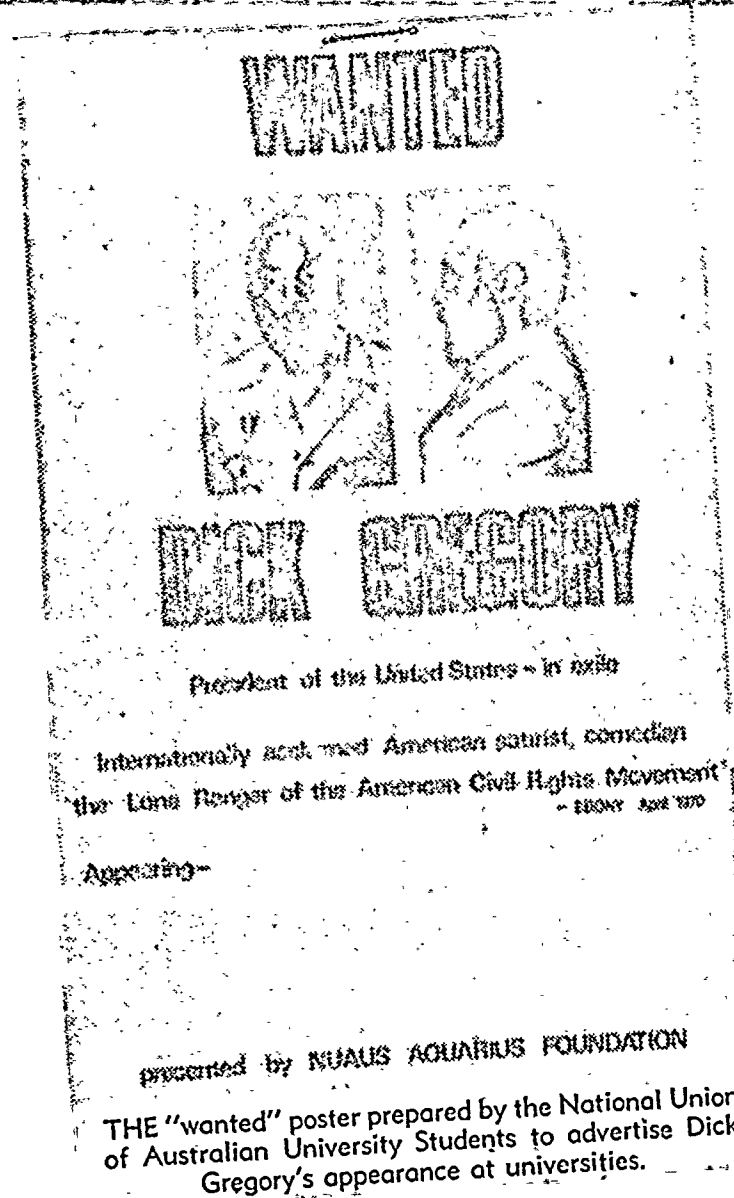

The Australian - Sept 27, 1970

Gregorian moratorium

BANNING BOOKS is bad enough, banning people is preposterous. To ban a man from visiting Australia the Federal Government ought to have the strongest evidence that he is likely to cause great harm. That is certainly not the case in the banning of entertainer Dick Gregory.

Mr Gregory was invited to come to Australia to make speeches at universities and moratorium rallies. On his visa application, he gave "sightseeing" as the reason for his visit.

To refuse a visa on the technical ground that this is not an accurate description of the proposed visit is ridiculous; it also shows a distinct lack of a sense of humor. At most all that was called for was the filing of a new visa application.

But the Government's real reason is that Mr Gregory is opposed to the Vietnam war, and might influence others to accept his view. It believes that it would be contrary to Australia's national interest for Mr Gregory to take part in the moratorium.

How extraordinarily vulnerable the Government must feel to over-react so badly. It is surprising it didn't consider refusing re-entry to Dr Cairns when he went overseas. Or Mr Whitlam.

Surely Australia's national interest is not threatened by a comedian who advocates full civil rights for black people and a cessation of the Vietnam war. The country doesn't need to be protected from men like that, but from the whims of people who try to keep our minds closed.

THE AUSTRALIAN: SYDNEY: 20-24 Holt St., Surry Hills, 211-5568; MELBOURNE: 32 Walsh St., 329-3333; CANBERRA: 42 North St., 48-5868; ADELAIDE: 116 North Tce., 51-0351; BRISBANE: 5th Floor, Penny's Building, Queen St., 21-6111; PERTH: 31 Stirling St., 28-8000; HOBART: Box 6633, 2-1260.

Sydney Morning Herald - Sept 4, 1970

Govt abusing its powers—Murphy

The Senate Leader of the Opposition, Senator Murphy, accused the Government of abusing its powers to deny freedom of speech in Australia.

He said the Government had refused American Negro Dick Gregory a visa to visit Australia because he had committed "the twin crimes" of holding different views from the Government on the Vietnam war and of being black.

On Wednesday, the Minister for Immigration, Mr Lynch, told the House the Government had refused a visa for Gregory to attend the Moratorium campaign because Gregory's entry would pose a "threat to law and order."

Senator Murphy was speaking on an urgency motion he moved on "the attack on freedom in Australia involved in the Government's refusal to allow Mr Dick Gregory to enter this country."

He said Australia was getting a reputation all around the world for being racist.

The Government had signed the universal declaration of civil rights which gave everyone the right to express his opinions but the Gregory case was another example that the Government "is breaking this down."

Senator Murphy said the Opposition was entitled to and would continue to speak out against involvement in the war.

One by one the Government was breaking down the liberties of the Australian people.

During a reply by the Minister for Housing, Senator Dame Annabelle Rankin, Senator A. Hendrickson (Lab, Vic) interjected: "You're a murderer."

Senator Hendrickson said he was provoked into making his interjection and withdrew it.

Senator Rankin said that at the same time as Mr Gregory applied for visa, the Australian Consul-General's office in New York had also received an application from a James Robert McGraw, president of the Columbia Baptist Church, New York.

He had also stated his purpose for the visa as "sight-seeing." "His visa was also refused," Senator Rankin said.

"The Leader of the Opposition tried to tell the people of Australia that the reason we had refused this man (Mr Gregory) was because he was coloured.

"But Mr McGraw is a white man."

The Deputy Leader of the DLP, Senator McManus, said protests against the Government's refusal to grant entry to Mr Gregory were based on phony emotionalism.

"The whole thing is a lot



SENATOR MURPHY

of hypocrisy by people who have no time for human rights and liberties but who are attempting to serve the interests of people in North Vietnam."

Senator McManus said the people who became worked up about Mr Gregory and South Vietnamese atrocities were cool and calm when they read about Vietcong firing shells into bunkers.

He said the Moratorium organisers wanted to import Mr Gregory as a "stirrer" to assist them in their program of depriving other people of their civil rights.

Senator McManus said he had heard Mr Gregory had been asked to come to Australia on a business basis and would have been paid \$1,000 for his Moratorium activities.

"Mr Gregory's principles seem to depend a good deal on his pocket," he said.

Senator J. M. Wheeldon (Lab, WA) accused the Government of having a double standard over Mr Gregory.

"They are the ones who

posture as defenders of democracy and yet at the same time they prevent free transit of a person into this country without producing one shred, one tittle of evidence as to why they did it," he said.

Senator Sir Magnus Cormack said that Mr McGraw had edited a book of Mr Gregory's writings which had been published in the United States.

He said Mr Gregory had "clearly and unequivocally" advocated the use of force to gain civil rights for Negroes in the United States.

Closing the debate, Senator Murphy accused Government Senators of racism.

"I have heard members of your party speak about niggers and, 'those niggers are not fit to govern themselves,'" he said.

"This is rampant throughout your party."

Government voice:

"That's not true."

The motion was later lost 24-23. The DLP voted with the Government.

In the House, the Minister for External Affairs, Mr McMahon, said leaders of the Moratorium committee were favouring a regime which had committed ruthless murders.

"They must ask themselves what would happen if the free allied cause was defeated, not only in South Vietnam but also in Laos and Cambodia," he said.

"Surely we must assume that exactly the same ruthless measures would be followed."

SYDNEY MORNING HERALD

4 SEPTEMBER 1970

UNITED STATES GOVERNMENT

Memorandum

~~CONFIDENTIAL~~

TO : DIRECTOR, FBI (100-440423)

DATE: OCT 5 1970

FROM: SAC, CHICAGO (157-347) (P)

SUBJECT: RICHARD CLAXTON GREGORY
RM - BN

Re Bureau airtels, 8/24/70 and 8/25/70.

Enclosed for the Bureau are 12 copies of an LHM captioned and dated as above. No local dissemination being made as the activity being reported does not involve other agencies within this Division, and could possibly serve to pinpoint this source.

Source is

Enclosed memorandum is classified confidential to protect the identity of the source, who is of continuing value.

Subject is an Agitator Index (AI) subject and his activities are being constantly followed and promptly reported.

APPROPRIATE AGENCIES AND FIELD OFFICES ADVISED BY ROUTING SLIP ON 8-27-80

1-16-80
CLASS. & EXT. BY 2842 PVD/cv
REASON-FCIM II, 1-2.4.2.2
DATE OF REVIEW 10-5-90

REC 83

EX-102

100-440423-570

4 OCT 8 1970

- 4 - Bureau (Encl. 12) (RM)
- (1 - 100-458079) (AUSTRALIAN VIETNAM MORATORIUM)
- 3 - Chicago
- (1 - A)
- (1 - 100-49406)

HHS/kml
(7)

Ma
ENCLOSURE
1-9

b6
b7C
b7D

UNREC COPY AND COPY OF ENCL FILED IN

~~CONFIDENTIAL~~

Buy U.S. Savings Bonds Regularly on the Payroll Savings Plan

55 OCT 15 1970



UNITED STATES DEPARTMENT OF JUSTICE

FEDERAL BUREAU OF INVESTIGATION

Chicago, Illinois

OCT 5 1970

In Reply, Please Refer to
File No. CG 157-347

~~CONFIDENTIAL~~

~~CONFIDENTIAL~~

RICHARD CLAXTON GREGORY
ALSO KNOWN AS DICK GREGORY

On September 18, 1970, a confidential source, who has furnished reliable information in the past, advised that on September 17, 1970, Dick Gregory

[redacted] had been denied a visa to enter Australia, by the Australian Immigration Ministry. ~~(S)~~ (U)

b7D

Dick Gregory, by profession, is a nightclub entertainer (comedian), who, in the past, has concerned himself with civil rights and social issues, and prefers to be known as "a commentator on affairs - social and political." During the school year, 1969-1970, Gregory spoke on the campuses of 320 colleges on the subjects of United States' racial problems and United States foreign policy; especially the "prosecution of the War in Vietnam."

Source advised that Gregory's purpose for wanting to go to Australia was to speak at a rally against the United States' continued presence in Vietnam. Gregory did not advise [redacted] any alternative plans he may have had, regarding any future attempt to visit Australia. ~~(S)~~ (U)

b7D

1-16-80
CLASS. & EXT. BY 2842 PVD/cj
REASON-FCIM II, 1-2.4.2 2
DATE OF REVIEW 11-5-90

~~CONFIDENTIAL~~

GROUP I

Excluded from automatic
downgrading and
declassification

This document contains neither recommendations nor conclusions of the Federal Bureau of Investigation. It is the property of the Federal Bureau of Investigation and is loaned to your agency; it and its contents are not to be distributed outside your agency.

- 1* - 100-440423-570
ENCLOSURE

~~CONFIDENTIAL~~

APPROPRIATE AGENCIES AND FIELD OFFICES ADVISED BY ROUTING SLIP ON 2-7-80

DIRECTOR, FBI (100-453079)

9/23/70

~~CONFIDENTIAL~~

SAC, CHICAGO (100-49406) (P)

AUSTRALIAN VIETNAM
MORATORIUM CAMPAIGN
IS - MISCELLANEOUS

Re Chicago letter to Bureau, 7/23/70.

By airtel dated August 25, 1970, the Bureau, under the caption "RICHARD CLAYTON GREGORY, RM - EM", advised that information had been received from the [redacted] that

[redacted] GREGORY and one [redacted]

[redacted] New York, New York, had made a joint application for a visa to visit Australia. They were scheduled to arrive [redacted]

[redacted] on route to Sidney and the duration of their stay would be two weeks. (U)

On September 18, 1970, [redacted] who has furnished reliable information in the past, advised that he learned that GREGORY had been refused entry into Australia in that his visa application for the purpose of sightseeing was not bona fide. Source said that as of that date, he had not learned anything further regarding GREGORY's travel plans. (U)

An LHM regarding GREGORY's proposed travel to Australia will be submitted under Chicago file 157-347 (Bufile 100-440423). (U)

Sources and informants of the Chicago Office could furnish no information indicating that Mrs. NANCY RUBIN, wife of JERRY RUBIN, or Mrs. CORETTA KING, are contemplating a trip to Australia. (U)

Chicago will continue to maintain contact with the sources regarding this matter.

- 3 - Bureau (RM)
- ① - 100-440423 (RICHARD CLAYTON GREGORY)
- 2 - Chicago
- (1 - 157-347) (RICHARD GREGORY)

100-440423-

SAM:kdj

(5)

66 OCT 1 11 19/70

CLASS. & EXT. BY 2842 PVL/ey
REASON-FCIM II, 1-2.4.2 2-13
DATE OF REVIEW 9-23-90

NOT RECORDED
172 SEP 28 1970

~~CONFIDENTIAL~~

ORIGINAL FILED IN 100-440423-9
b6
b7C
b7D

APPROPRIATE AGENCIES AND FIELD OFFICES ADVISED BY ROUTING SLIP ON 7-8-82

FEDERAL BUREAU OF INVESTIGATION
COMMUNICATIONS SECTION

OCT 6 1970

TELETYPE *sl*

- Mr. Tolson _____
- Mr. Sullivan _____
- Mr. Mohr _____
- Mr. Bishop _____
- Mr. Brennan *CB*
- Mr. Callahan _____
- Mr. Casper _____
- Mr. Conrad _____
- Mr. Felt _____
- Mr. Gale _____
- Mr. Rosen _____
- Mr. Tavel _____
- Mr. Walters _____
- Mr. Soyars _____
- Tele. Room _____
- Miss Holmes _____
- Miss Gandy _____

NR002 TP PLAIN

0110 456 PM URGENT 10-6-70 WRB

TO DIRECTOR 157-12382

CHICAGO 157-347

FROM TAMPA 157-3163

D
RICHARD CLAXTON GREGORY. RM. 00: TP.

DETECTIVE

ADVISED INSTANT DATE THAT SUBJECT IS SCHEDULED TO MAKE
 SPEECH AT ROLLINS COLLEGE FIELD HOUSE, WINTER PARK, FLORIDA
 AT EIGHT PM, OCTOBER SEVENTH, NEXT. APPEARANCE OF SUBJECT
 SPONSORED BY STUDENT EDUCATIONAL ENTERTAINMENT COMMITTEE,
 ROLLINS COLLEGE AND TOPIC OF SPEECH WILL BE "SOCIAL PROBLEMS-
 SOCIAL OR ANTI-SOCIAL."

b6
b7c

n

AD 14
COVERAGE WILL BE AFFORDED SPEECH AND ARRANGEMENTS BEING _____

REC 85 100-440423-571

MADE TO RECORD SAME. P.

18 OCT 12 1970

END

ALL INFORMATION CONTAINED
HEREIN IS UNCLASSIFIED
DATE 1-16-80 BY 2842/cv

GMV. WASH DC FBI OK

5-

60 OCT 16 1970

"cc to IDIU
Adm. data deleted"

cc - Mr. Grandi

FBI

Date: 10/6/70

Transmit the following in _____
(Type in plaintext or code)

Via A I R T E L _____
(Priority)

b6
b7c

TO: DIRECTOR, FBI (100-440423)

FROM: SAC, MIAMI (157-1564) (P)

RICHARD CLAXTON GREGORY, aka
RM-BN

Enc. for the Bureau are eight copies of an LHM dated and captioned as above. Two copies are enclosed for Chicago.

Local authorities are cognizant of subject's intended visit to the Miami area.

Chicago is requested to advise if there is any specific coverage requested of GREGORY's visit to the Miami area.

Miami will follow and report on subject's visit.

ALL INFORMATION CONTAINED
HEREIN IS UNCLASSIFIED
DATE 1-16-80 BY 2842/ce

ENCLOSURE

EX-112

REG 85

- 2 - Bureau (Enc. 8) (RM)
- 2 - Chicago (157-347) (Enc. 2) (RM)
- 2 - Miami (1 - 157-1564)
(1 - 157-1087)

100-4410423-572

JCM/jgs
(6)

OCT 9 1970

b6
b7c

AGENCY: ICDSO, SEC. SERV.,
DEPT: ISD, IDIU,

HOW FORW: RS
DATE FORW: 10-12-70 10083608
BY: [Signature]

Approved: [Signature] Sent _____ M Per _____
Special Agent in Charge

66 OCT 16 1970



UNITED STATES DEPARTMENT OF JUSTICE

FEDERAL BUREAU OF INVESTIGATION

Miami, Florida
October 6, 1970

In Reply, Please Refer to
File No. 157-1564

RE: RICHARD CLAXTON GREGORY
RACIAL MATTERS - BLACK NATIONALIST

[redacted] advised on October 6, 1970, that RICHARD CLAXTON GREGORY, who is also known as Dick Gregory, is scheduled to appear at Florida Memorial College on October 20, 1970. He said GREGORY's appearance will be an official college function in connection with their Lyceum series of lectures.

[redacted] described GREGORY, a nationally known night club entertainer, as a civil rights activist who has publicly endorsed civil disobedience and militant action by Negroes under the auspices of the civil rights movement.

[redacted] said that Florida Memorial College is a predominantly Negro college located in the Opa-Locka section of Dade County, Florida.

Copies of this memorandum are being furnished to the U. S. Attorney, U. S. Secret Service and 111th M. I. Group, Miami, Florida.

This document contains neither recommendations nor conclusions of the FBI. It is the property of the FBI and is loaned to your agency; it and its contents are not to be distributed outside your agency.

ALL INFORMATION CONTAINED
HEREIN IS UNCLASSIFIED
DATE 1-16-80 BY 2842/ea

- 1* -

100-940423-572

ENCLOSURE

b6
b7c

~~CONFIDENTIAL~~

Date: October 7, 1970
To: Director, FBI (100-440423)
From: Legal Attache, Rome (157-22) (RUC)
Subject: RICHARD CLAXTON GREGORY
RM - BN

Reference: Bureau airtel 8/25/70.

Information set forth in the enclosed memorandum was received on 10/6/70 from:

- Italian Defense Intelligence Service (SID)
- Division of Confidential Matters, Italian National Police
- Central Bureau, Italian Criminal Police
- Political Section, Police Headquarters, Rome, Italy
- Foreigners Section, Police Headquarters, Rome, Italy
- Other:

Classified by Source: UNCLASSIFIED

Remarks:

1-16-80
CLASS. & EXT. BY 2842 pbl/ci
REASON-FCIM II, 1-2.4.2 2-3
DATE OF REVIEW 10-7-90

APPROPRIATE AGENCIES AND FIELD OFFICES ADVISED BY ROUTING SLIP ON 2-7-80 gab.

REC-32 100-440423-573
EX-113

14
9 OCT 12 1970

(4) Bureau (Enc- 7) (1 - Foreign Liaison Desk)
(1 - Chicago 157-347)
1 Rome

TJB:MEG
51051 20 1970 - ENCL 3



b6
b7c

~~CONFIDENTIAL~~

1 cc encls to NY & CG
by RS on 10-14-70 for info.
C.E.E./admin/decid

Encl

low 560

(U)

31

EXP. 1970



UNITED STATES DEPARTMENT OF JUSTICE
FEDERAL BUREAU OF INVESTIGATION

WASHINGTON, D.C. 20535

In Reply, Please Refer to
File No.

October 7, 1970

~~CONFIDENTIAL~~

RICHARD CLAXTON GREGORY

The records of the Foreigners' Office, Police Headquarters, Rome, Italy, revealed that RICHARD CLAXTON GREGORY, born October 12, 1932, in possession of U. S. passport No. K-761916, issued at Washington, D. C., on June 5, 1969, registered at the Hotel Parco dei Principi on September 5, 1970. He was accompanied by [redacted]

[redacted] in possession of U. S. passport [redacted] issued at Washington, D. C., on [redacted] ~~(U)~~

b6
b7c

GREGORY and [redacted] stayed at the hotel until September 9, 1970, when they left Rome for an unknown destination. ~~(U)~~

1-16-80
CLASS. & EXT. BY 2842 PVD/cw
REASON-FCIM II, 1-2.4.2 2, 3
DATE OF REVIEW 10-7-90

APPROPRIATE AGENCIES AND FIELD OFFICES
ADVISED BY ROUTING SLIP ON 2-7-80 jst

-1*-

~~CONFIDENTIAL~~
PROPERTY OF THE FBI
This report is loaned to
you by the FBI, and neither
it nor its contents are to
be distributed outside the
agency to which loaned.

100-440423-573

~~CONFIDENTIAL~~

FEDERAL BUREAU OF INVESTIGATION
COMMUNICATIONS SECTION
OCT 13 1970

~~CONFIDENTIAL~~

me TELETYPE

- Mr. Tolson _____
- Mr. Sullivan _____
- Mr. Mohr _____
- Mr. Bishop _____
- Mr. Brennan *[initials]*
- Mr. Callahan _____
- Mr. Casper _____
- Mr. Conrad _____
- Mr. Felt _____
- Mr. Gale _____
- Mr. Rosen _____
- Mr. Tavel _____
- Mr. Walters _____
- Mr. [unclear] _____
- Tele. Room _____
- Miss Holmes _____
- Miss Gandy _____

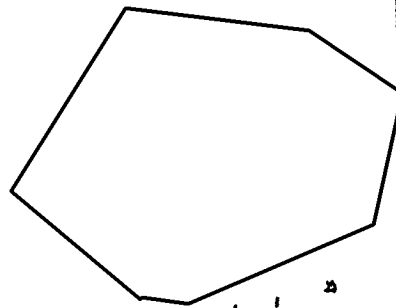

b6
b7c

NR027 SL PLAIN

024PM NITEL 10-13-70 JMS

TO DIRECTOR (100-440423)

CHICAGO (157-347)

FROM ST. LOUIS (157-5822) 1P

1-16-80
CLASS. & EXT. BY 2842 PDK/ci
REASON-FCIM II, 1-2.4.2
DATE OF REVIEW 10-13-90

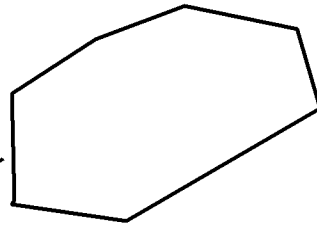

RICHARD CLAYTON GREGORY, AKA; RM; OO: CHICAGO

ON OCT. ELEVEN, LAST, [redacted] ADVISED

b7D

THAT GREGORY WILL SPEAK AT ST. LOUIS UNIVERSITY AT EIGHT PM ON OCT. FIFTEEN, NEXT, AS PART OF THE UNIVERSITY SPEAKERS SERIES PROGRAM. (U)

APPROPRIATE AGENCIES ADVISED. ST. LOUIS DIVISION INFORMANTS WILL COVER. BUREAU WILL BE ADVISED BY LHM UPON COMPLETION OF SPEECH. (U)

P
END
APPROPRIATE AGENCIES AND FIELD OFFICES ADVISED BY ROUTING SLIP ON 2-7-80 *gab.*

ACK FOR NR010, 030, 022, 016, 023, 027.

EJF FBI WASH D C

REC-57
EX-113

100-440423-574
OCT 15 1970

cc to IDIU
Adm. data deleted
MR. TRAINOR
ROOM 724 9&D

cc -



FBI

Date: 10/8/70

Transmit the following in: AIRTEL (Type in plaintext or code)

Via _____ (Priority)

TO: DIRECTOR, FBI (100-440423)

FROM: SAC, CHARLOTTE (157-5865)

APPEARANCE OF RICHARD CLAXTON

GREGORY AT SHAW UNIVERSITY,

RALEIGH, N. C.,

10/5/70

RM - BN

ALL INFORMATION CONTAINED
HEREIN IS UNCLASSIFIED
DATE 1-16-80 BY 2842/cw

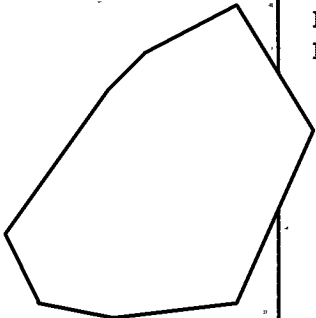

b6
b7C

Enclosed for the Bureau are eleven (11) copies of LHM re captioned matter, copies of which are being disseminated locally to military intelligence and Secret Service. Enclosed for Chicago are two copies of this LHM.

CE T-1 is [redacted] (PROB) who furnished information to SA [redacted] All investigation set forth in LHM conducted by SA [redacted] with exception of investigation on 10/6/70, which was conducted by SA [redacted]

b6
b7C
b7D

No recordings of GREGORY's speech are known to have been made and therefore none obtained.

- 2 - Bureau (Encs. 11) (RM)
- 2 - Chicago (157-347) (Encs. 2) (RM)
- 4 - Charlotte (2-157-5865)
 - (1- [redacted])
 - (1-157-177 Sub B)

REC-4 EX-102

100-440423-575

b7D

RRG:jwr
(8)

OCT 14 1970

AGENCY: ICDSO, ~~SEC. SERV.~~, ~~IRS~~
DEPT: ~~ISD~~, ~~IDIU~~, ~~SD~~

b6
b7C

HOW FORW: RS
DATE FORW: 10-15-70
BY: CEE/ [signature] 10083608



50 OCT 23 1970 FW
Approved _____
Special Agent in Charge

Sent _____ M Per _____



UNITED STATES DEPARTMENT OF JUSTICE
FEDERAL BUREAU OF INVESTIGATION

Charlotte, North Carolina
October 8, 1970

In Reply, Please Refer to
File No.

APPEARANCE OF RICHARD CLAXTON
GREGORY AT SHAW UNIVERSITY,
RALEIGH, NORTH CAROLINA,
OCTOBER 5, 1970
RACIAL MATTERS

On October 2, 1970, CE T-1 advised that comedian RICHARD CLAXTON GREGORY, known as "Dick" Gregory, was scheduled to speak at Shaw University, Raleigh, North Carolina, on October 5, 1970, at 8:00 p.m. T-1 stated that GREGORY's appearance is sponsored by the Shaw Student Union and further that GREGORY will be paid \$1,100 for his appearance.

On October 2, 1970, Captain [redacted] North Carolina, Police Department, and [redacted] North Carolina, [redacted]

[redacted] were advised of GREGORY's scheduled appearance.

On October 6, 1970, Captain [redacted] supra, advised no incidents had been reported in connection with GREGORY's appearance at Shaw University.

On October 8, 1970, T-1 advised that on the night of October 5, 1970, GREGORY, beginning at approximately 8:00 p.m., spoke to about seven hundred persons in the Spaulding

THIS DOCUMENT CONTAINS NEITHER RECOMMENDATIONS
NOR CONCLUSIONS OF THE FBI. IT IS THE PROPERTY
OF THE FBI AND IS LOANED TO YOUR AGENCY; IT AND
ITS CONTENTS ARE NOT TO BE DISTRIBUTED OUTSIDE
YOUR AGENCY.

ALL INFORMATION CONTAINED
HEREIN IS UNCLASSIFIED
DATE 1-16-80 BY 2842/cw

100-440423-575

ENCLOSURE

b6
b7c

APPEARANCE OF RICHARD CLAXTON
GREGORY AT SHAW UNIVERSITY,
RALEIGH, NORTH CAROLINA,
OCTOBER 5, 1970

Gymnasium on the campus of Shaw University, Raleigh, North Carolina. The audience was made up of ninety-nine per cent blacks and GREGORY was well received.

T-1 said that GREGORY spoke about the black movement, the need for it and the need for blacks to participate in it. GREGORY stated that the present NIXON Administration, including Vice President AGNEW, is not black orientated and does not appear to be on the side of the blacks.

T-1 said that GREGORY stated the future of this country rests with college students. GREGORY went on to say that things have not changed much in four hundred years although the young folks have come up with a moral thrust that scares the old folks. GREGORY said that the noises made by kids running around the streets today were only a warning but said it is the last warning this country is going to get and added, "The country better make some quick adjustments or she is going to blow it."

T-1 said there were no incidents.



UNITED STATES DEPARTMENT OF JUSTICE
FEDERAL BUREAU OF INVESTIGATION

Charlotte, North Carolina
October 9, 1970

In Reply, Please Refer to
File No.

Title	APPEARANCE OF RICHARD CLAXTON GREGORY AT SHAW UNIVERSITY, RALEIGH, NORTH CAROLINA, OCTOBER 5, 1970
Character	RACIAL MATTERS
Reference	Memorandum prepared at Charlotte, North Carolina, dated and captioned as above.

All sources (except any listed below) whose identities are concealed in referenced communication have furnished reliable information in the past.

FBI

Date: 10/15/70

Transmit the following in _____
(Type in plaintext or code)

Via AIRTEL _____
(Priority)

TO: DIRECTOR, FBI (100-440423)
FROM: SAC, CHARLOTTE (157-5865) (C)

APPEARANCE OF RICHARD CLAXTON
GREGORY AT GUILFORD COLLEGE,
GREENSBORO, N. C.,
10/8/70
RM - BN

Re Charlotte airtel 10/8/70 enclosing LHM to Bureau.

Enclosed to Bureau are eleven copies of LHM re captioned matter. Copies disseminated locally to Military Intelligence and Secret Service.

Enclosed for Chicago are two copies of this LHM.

No recording of GREGORY's speech is known to have been made.

Investigation, Greensboro, N. C., conducted by SA

[Redacted]

Since GREGORY has appeared in the Charlotte Division and no further appearances are scheduled, this case is being closed.

ENCLOSURE

- 2-Bureau (Encs. 11) (RM)
- 2-Chicago (157-347) (Encs. 2) (RM)
- 1-Charlotte

REC-84

100-440423-576

EX-111

GDF:jeb
(5)

ALL INFORMATION CONTAINED
HEREIN IS UNCLASSIFIED
DATE 1-16-80 BY 2842/cc

OCT 19 1970

59 OCT 27 1970

Approved: _____
Special Agent in Charge

Sent _____ Per _____

AGENCY: ICDSO, SEC. SERV., IDIU, ISD, RS
HOW FORW: 10-20-70
DATE FORW: 10-20-70
BY: G.F.F. / [Signature] 5880

b6
b7c



UNITED STATES DEPARTMENT OF JUSTICE

FEDERAL BUREAU OF INVESTIGATION

Charlotte, North Carolina

In Reply, Please Refer to
File No.

October 15, 1970

APPEARANCE OF RICHARD CLAXTON
GREGORY AT GUILFORD COLLEGE,
GREENSBORO, NORTH CAROLINA,
OCTOBER 8, 1970
RACIAL MATTERS

The Greensboro Daily News, in its issue of October 9, 1970, reported that GREGORY had appeared before an overflow audience at Guilford College's Dana Auditorium the previous night, October 8, 1970. GREGORY had pled for the youth to support the women's liberation movement and had denounced the nation's war policies, according to the article. He had also defended college youth against their detractors and warned of the dangers of suppression.

The article stated that the audience was made up in a large part by college students, who applauded vigorously when told by GREGORY that a big job faced them in saving America, "even if you have to alienate your mama and papa".

The article concluded by saying that GREGORY had cautioned against violence, saying "You can't cure America with dynamite and double barreled shotguns. If you think the way to save crazy folk is to dynamite them, then you're crazier than they are". GREGORY was also quoted as saying "If democracy is as good as they tell you, why are we going all over trying to ram it down people's throats with guns?" He compared repression to plugging the spout of a boiling tea pot, causing it to blow up.

THIS DOCUMENT CONTAINS NEITHER
RECOMMENDATIONS NOR CONCLUSIONS
OF THE FBI. IT IS THE PROPERTY
OF THE FBI AND IS LOANED TO
YOUR AGENCY; IT AND ITS CONTENTS
ARE NOT TO BE DISTRIBUTED OUTSIDE
YOUR AGENCY.

ALL INFORMATION CONTAINED
HEREIN IS UNCLASSIFIED
DATE 1-16-80 BY 2842/cu

100-440423-576

ENCLOSURE

APPEARANCE OF RICHARD CLAXTON
GREGORY AT GUILFORD COLLEGE,
GREENSBORO, NORTH CAROLINA,
OCTOBER 8, 1970

Lieutenant [redacted] North Carolina,
Police Department, [redacted] advised October 8, 1970,
that GREGORY's speech had been held on the campus of Guilford
College without any incidents of any kind occurring.

b6
b7C

FBI

Date: 10-19-70

Transmit the following in _____
(Type in plaintext or code)

Via AIRTEL AIRMAIL
(Priority)

TO: DIRECTOR, FBI (100-440423)
FROM: SAC, ST. LOUIS (157-5822) -RUC-
RE: RICHARD CLAXTON GREGORY, aka
Dick Gregory
RM
OO: CHICAGO

1-16-80
CLASS. & EXT. BY 2842 PVD/ci
REASON-FCIM II, 1-2.4.2.2
DATE OF REVIEW 10-19-90

Re St. Louis teletype to Bureau, 10-13-70. *lvw547*

Enclosed for the Bureau are eleven copies and for Chicago two copies of a self-explanatory LHM reflecting GREGORY's speech in St. Louis, Mo. on 10-15-70.

Copies of this LHM are being furnished locally to the U. S. Attorney, U. S. Secret Service, and 113th MI Group III.

This LHM is being classified CONFIDENTIAL because it contains information from racial informants of continuing value.

Sources in this LHM are as follows: *c*

- 2 - Bureau (Encl. 11)
- 2 - Chicago (157-347) (Encl. 2) (RM)
- 2 - St. Louis (1-157-5822) (1-100-21599) (SLU)

JAF:klb
(6)

OCT 22 1970

ENCLOSURE REG 15 EX-111

100-440423-577

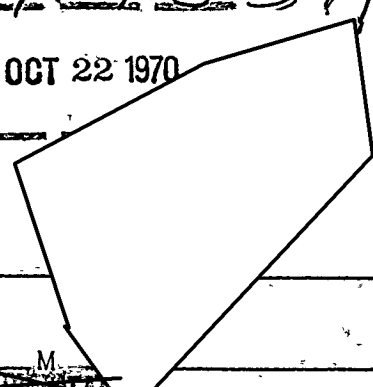

MU
AGENCY: ~~FBI~~ SEC. SERV., ~~FIS~~
DEPT: ~~ISD~~
HOW FORW: *RS*
DATE FORW: *10-23-70*
BY: *CEH/llm/ged*

APPROPRIATE AGENCIES AND FIELD OFFICES ADVISED BY ROUTING SLIP ON 2-8-80 *llm*

b6
b7c

54 OCT 29 1970

Approved: *[Signature]*
Special Agent in Charge

Sent

~~CONFIDENTIAL~~

SL 157-5822

~~CONFIDENTIAL~~

SL T-1 is [redacted]

SL T-2 is [redacted]

(U)

~~SECRET~~

(PROTECT BY REQUEST).

b6
b7C
b7D

SL T-3 is [redacted] (PROB).

No attempt was made by the St. Louis Division to tape GREGORY's speech. [redacted] (PROB) personally attended the speech. ~~SECRET~~ (U)

~~CONFIDENTIAL~~



UNITED STATES DEPARTMENT OF JUSTICE
FEDERAL BUREAU OF INVESTIGATION

In Reply, Please Refer to
File No.

St. Louis, Missouri

October 19, 1970

~~CONFIDENTIAL~~

RICHARD CLAXTON GREGORY

On October 11, 1970, SL T-1 advised that the Busch Student Activities Board, an official body of St. Louis University, had scheduled Dick Gregory to speak at their campus on October 15, 1970 in the Sesquicentennial Room of Busch Memorial Center. The speech was part of the regular Speaker's Series at the university. ~~(S)~~ (U)

On October 14, 1970, a letter was received from an anonymous source by St. Louis University officials which was postmarked St. Louis, Missouri. The letter read as follows:

"FREE DEPUGH

FREE DEPUGH

"BLACK BOGUS BABY IS BACK ON THE TOWN

"Make him know He's Not Welcome

¹⁻¹⁶⁻⁸⁰
CLASS. & EXT. BY 2842 PVD/cei
REASON-FCIM II, 1-2.4.2 2
DATE OF REVIEW 10-19-90

"BOYCOTT, Disrupt His Speech

"The Commie Niggerpig and Civil Riots Advocate.
DIRTY DICK GREGORY will be speaking at St. Louis
U. in the Sesquicentennial Room on Oct. 15 1970
At 8 P.M. Join us at Grand & Lindell At 7:30 P.M.
and March On Him.

INSULT HIM

"Tell the Pig to GET OUT OF TOWN.

"Treason Must Be Punished Fourth of July Movement."

~~CONFIDENTIAL~~

PROPERTY OF FBI

This communication and its contents are loaned to you by the FBI, and neither it nor its contents are to be distributed outside of the agency to which loaned.

GROUP 1

Excluded from automatic downgrading and declassification.

ENCLOSURE

100-440423 - 577

APPROPRIATE AGENCIES AND FIELD OFFICES
ADVISED BY ROUTING SLIP ON 2-8-80

RICHARD CLAXTON GREGORY

~~CONFIDENTIAL~~

No information exists concerning the "Fourth of July Movement" and university officials were of the opinion the letter was the work of an isolated crank.

On October 15, 1970, SL T-2 advised that approximately 1,500 people, the majority of college age, attended Gregory's speech at St. Louis University which began about 8:00 P.M. on October 15, 1970. St. Louis University students were admitted free; the others paid \$1.50. The racially mixed audience responded well to Gregory's speech. This source advised that Gregory was paid \$1,000 for the speech, although university officials declined to confirm this officially. ~~(S)~~ (U)

On October 15, 1970, SL T-3 advised that Gregory's speech, which lasted approximately one and one-half hours, was more of a series of jokes and barbs directed against a long list of Gregory's targets, including Federal and state officials, the police, the "hard-hats", newspapers, and numerous others. Gregory did not advocate violence during this speech. This source advised there were no attempts to disrupt, demonstrate against, or heckle Gregory's speech. ~~(S)~~ (U)

There were no arrests in connection with the above speech.

~~CONFIDENTIAL~~

An article appeared on page 4A of the October 16, 1970 issue of the St. Louis Globe-Democrat, a daily newspaper published in St. Louis, Missouri, relating to this speech. This article is reproduced below.

Gregory Jokes Yield To Political Lesson

By CHARLES STAPLES
Globe-Democrat Staff Writer

With a sure touch, Dick Gregory humorously enthralled his audience at St. Louis University Thursday night, and then sobered it with the theme that repression against activists should be viewed as the natural response to the nation's fear of a moral force.

Between the Agnew and Nixon jokes, the message was for young American activists to expect repression as a natural reaction to fear, caused by them taking a moral issue to the streets.

"Repression is more detrimental to the oppressor than to the oppressed," he told the sell-out crowd of about 600.

In a speech filled with symbolism, he likened repression to trying to plug a teakettle to stop its whistling.

"WHEN A teakettle blows in one-room kitchenette, everybody gets burned. When a whole country reacts with fear to a moral force, there is only one way for it to go down."

Gregory's speech, the first of a series sponsored by the University's Student Activities Board, also dealt with his being named by U.S. Rep. Richard

Ichord as a college speaker tied in with left-wing groups.

The comedian-turned political activist looked gaunt as a result of his numerous fasts. He wore the movement-type denim jacket.

While he did not speak on the merits of street demonstrations directly, he told the gathering, "If the German youth had forced Hitler to come on campus and gas them, the whole world would have been alerted to him."

GREGORY SAID the solution to the whistling teakettle was not to try to repress the noise, but to fix conditions that made it boil.

"Law and order will be a problem until the freaks in Washington stop talking law and order and start talking bread and butter," he said.

Gregory told the predominantly youthful audience:

"You young people are the most morally upright people in the world today."

An article appeared on page 2A of the October 16, 1970 issue of the Metro-East Journal, a daily newspaper published in East St. Louis, Illinois, relating to this speech. This article is reproduced below.

Gregory: 'When country is afraid of moral force, it's on way down'

By John Shaffer
Metro-East Journal Staff

"When a country is afraid of a moral force, that country is on its way down," comedian Dick Gregory told an overflow crowd at St. Louis University Thursday night.

Gregory, who attended Southern Illinois University—Carbon-dale and now is a militant spokesman for black rights, mixed humor with philosophy as he said the future of this nation rests with today's students.

"I hope you understand your importance," he told the students. "I hope you understand who you are. I hope you understand the destiny of America depends on you."

Between his serious and reflective moments, his humour touched many bases.

On President Nixon—"I feel much better this week than last week because Nixon came back home. Whenever the President leaves the country I get scared because I figure he knows something I don't."

On Vice President Agnew — "Agnew reminds me of the kind of cat who would make a crank call to Russia on the hotline. He seems so dumb, I wouldn't be surprised if he hijacks a train one day."

On dumping poisonous gases in the Atlantic Ocean—"I hate to see it dumped out there, but it sure is better than in the ghetto."

On the senators who recently

questioned him about his civil rights activities before a Senate subcommittee—"Here are cats who spend \$2 million getting elected to a job that pays \$55,000 a year."

On his kids—"My son thinks I'm a square. I haven't made the FBI's 10-most-wanted list, yet."

On Nixon's election in 1968—"Americans have been going to the polls for so long hoping to elect the lesser of two evils, it was due time you were going to get the eviler of the evils."

Gregory said he spends about 98 per cent of his time on campus in recent months, and today's generation of students is the most moral of any generation.

Lashing out at what he called the "right-wing, cracker-controlled newspapers" of the St. Louis area, he said law and order is going to continue to be a problem in this country until those in Washington "stop talking about law and order and start talking about a brand new government."

He said the government could "fall from within" in four to six years.

Gregory said today's repression of youths is caused by the

youths "bringing this great moral force to the streets."

"Man has a right to be afraid. It is also man's right to react to that fear," Gregory said.

"You young folks have scared us to death with this moral force," he said, citing recent acts by "hardhats."

Saying that a country afraid of a moral force shows the country is "on its way down," Gregory said both Nixon and Agnew are always talking derogatory of students but not dope pushers.

"If Nixon and Agnew would only spend half their time badmouthing kids, and the other half of their time badmouthing dope pushers, maybe some of those hardhats would get mad sometime during their lunch hour and attack a dope pusher."

Comparing a revolution to a boiling teakettle, he said you can plug up a teakettle to stop its whistle but unless the pressure is relieved, "it's going to blow."

He said youths taking to the streets should be a warning signal, like the teakettle's whistle.

"When this thing blows, if it comes to that, America's going to blow and everybody's going to go," he warned.



UNITED STATES DEPARTMENT OF JUSTICE
FEDERAL BUREAU OF INVESTIGATION

*In Reply, Please Refer to
File No.*

Title RICHARD CLAXTON GREGORY

Character

Reference St. Louis memorandum
dated October 19, 1970.

All sources (except any listed below) whose identities are concealed in referenced communication have furnished reliable information in the past.

F B I

Date: 10/22/70

Transmit the following in _____
(Type in plaintext or code)

Via A I R T E L _____
(Priority)

b6
b7C

TO: DIRECTOR, FBI (100-440423)
FROM: SAC, MIAMI (157-1564) (RUC)

RICHARD CLAXTON GREGORY
RM - BN
(OO: CHICAGO)

Re Miami airtel and LHM, 10/6/70.

Enc. for the Bureau are eight (8) copies of an LHM, dated and captioned as above. Two copies are enclosed for Chicago.

Sources and informants of the Miami Office reported no activities in the Miami area in connection with GREGORY's visit.

ALL INFORMATION CONTAINED
HEREIN IS UNCLASSIFIED
DATE 1-16-80 BY 2842/c

b6
b7C

AGENCY: ICDSO, SEC. SERV., DEPT. ISD
HOW FORW: *RS*
DATE FORW: *10-27-70*
BY: *[Signature]*

M2
ENCLOSURE

REC-2
EX-102
REC-89
100-1443-578

OCT 24 1970

- ② - Bureau (Enc. 8) (RM)
- 2 - Chicago (157-347) (Enc. 2) (RM)
- 3 - Miami (1 - 157-1564)
(1 - 157-1087)
(1 - 157-3826)

JCM/jgs
(7)

RACIAL INT. SECT.

56 NOV 5 1970
Approved: *[Signature]*
Special Agent in Charge

Sent _____ M Per _____



UNITED STATES DEPARTMENT OF JUSTICE

FEDERAL BUREAU OF INVESTIGATION

Miami, Florida
October 22, 1970

In Reply, Please Refer to
File No. 157-1564

RE: RICHARD CLAXTON GREGORY
RACIAL MATTERS - BLACK NATIONALIST

It was reported by memorandum dated October 6, 1970, that RICHARD CLAXTON GREGORY, who is also known as Dick Gregory, a nationally known night club entertainer, and civil rights activist, was scheduled to speak at Florida Memorial College, Opa-Locka, Florida, October 20, 1970.

The October 20, 1970 edition of the "Miami Herald", a Miami, Florida daily newspaper, contained an article by Herald Staff Writer MIKE BAXTER captioned, "GREGORY Chokes Off Laughter". This article reported that DICK GREGORY spoke to 100 black students at Florida Memorial College Tuesday evening, October 20, 1970. During this speech he talked of the recent arrest of ANGELA DAVIS who he described as a "black Communist accused of buying the guns used in the San Rafael, California Court House parking lot shoot-out." He said that there was no way for her to have purchased those guns without the authorities knowing as she was watched "doubly", being both a black militant and a Communist. He stated "The good thing about the trial that will come out now is that the police killed the judge." He also indicated that DAVID R. POINDEXTER, JR., her companion when arrested, was a Government "agent". He cited a 1968 issue of the Black Panther newspaper which he indicated described POINDEXTER as an "agent". Fla

A characterization of the Black Panther Party (BPP) is contained in the Appendix section of this memorandum.

It was also reported that GREGORY said the Central Intelligence Agency (CIA) killed MARTIN LUTHER KING, MALCOLM X, the KENNEDYS and others. He predicted the United States would experience a CIA coup d'etat within

ALL INFORMATION CONTAINED
HEREIN IS UNCLASSIFIED
DATE 1-16-80 BY 2842/cv

100-440423-578
ENCLOSURE

RE: RICHARD CLAXTON GREGORY

about sixteen months. He said that he planned to move to Canada to avoid this CIA coup d'etat. He said the CIA has a "space sensor" that can over-fly a building and report on who is inside and who has ever been inside.

The article stated that GREGORY's appearance at Florida Memorial College was one of 300 appearances scheduled during a ten month period. From Miami he was flying to Wisconsin for another speech.

Officer [redacted]
[redacted] Dade County Public Safety Department, advised that there were no problems or activities at Florida Memorial College or in the Miami, Florida area during GREGORY's visit on October 20, 1970.

b6
b7c

Copies of this memorandum are being furnished to the U. S. Attorney, U. S. Secret Service and 111th M.I. Group, Miami, Florida.

This document contains neither recommendations nor conclusions of the FBI. It is the property of the FBI and is loaned to your agency; it and its contents are not to be distributed outside your agency.

APPENDIX

1 BLACK PANTHER PARTY (BPP),
 also known as
 Black Panther Party for Self-Defense

According to the official newspaper of the BPP, the BPP was started during December 1966 in Oakland, California, to organize black people so they can take control of the life, politics, and the destiny of the black community. It was organized by BOBBY G. SEALE, BPP Chairman, and HUEY P. NEWTON, Minister of Defense, BPP.

The official newspaper, called "The Black Panther," regularly states that the BPP advocates the use of guns and guerrilla tactics in its revolutionary program to end oppression of the black people. Residents of the black community are urged to arm themselves against the police who are consistently referred to as "pigs" who should be killed.

The newspaper, in its issue of September 7, 1968, had an article by the then Minister of Education, GEORGE MURRAY. This article ended with the following:

"Black men. Black people, colored persons of America, revolt everywhere! Arm yourselves. The only culture worth keeping is revolutionary culture. Change. Freedom everywhere. Dynamite! Black power. Use the gun. Kill the pigs everywhere."

The BPP newspaper, issue of October 5, 1968, had an article introduced with the following statement: "We will not dissent from American government. We will overthrow it."

DAVID HILLIARD, Chief of Staff, BPP, in a speech at the San Francisco Polo Field on November 15, 1969, said "We will kill Richard Nixon."

DAVID HILLIARD, in the "New York Times," issue of December 13, 1969, was quoted as follows: "We advocate the very direct overthrow of the government by way of force and violence."

In the issue of April 25, 1970, the BPP newspaper had an article by Minister of Culture EMORY DOUGLAS as follows:

APPENDIX

APPENDIX

2

"The only way to make this racist U.S. Government administer justice to the people it is oppressing, is...by taking up arms against this government, killing the officials, until the reactionary forces...are dead, and those that are left turn their weapons on their superiors, thereby passing revolutionary judgment against the number one enemy of all mankind, the racist U.S. Government."

The BPP headquarters is located at 1046 Peralta Street, Oakland, California. Branches of the BPP, and Committees to Combat Fascism, under control of the BPP, have been established in various locations in the USA.

APPENDIX

UNITED STATES GOVERNMENT

Memorandum

TO : DIRECTOR, FBI (100-440423)

DATE: 11/5/70

FROM : *CPH* SAC, CLEVELAND (157-1316) (RUC)

SUBJECT: RICHARD CLAXTON GREGORY, aka.
RM

OO: Chicago

Enclosed for the Bureau are 11 copies of a Letterhead Memorandum (LHM) regarding the appearance of captioned subject at Akron University, Akron, Ohio, on October 16, 1970. Two copies of this LHM are also included for the Chicago Office.

b6
b7c

- ENCLOSURE
- 2 - Bureau (Enc. 11) (RM)
 - 2 - Chicago (Enc. 2) (RM)
 - 1 - Cleveland

WEW/gjz
(5)

ALL INFORMATION CONTAINED
HEREIN IS UNCLASSIFIED
DATE 1-16-80 BY 2842/ew

67-112

duw

REC-47 100-440423-379

NOV 10 1970

AGENCY: ICDSO, ~~ITC~~, ~~OSI~~, SEC. SERV., ~~IS~~ ~~IS~~ ~~IS~~ - *attn Wright*
DEPT: ~~ISD~~, ~~CRD~~, IDIU, ~~CO~~

HOW FORW: *RZ*
DATE FORW: *11/10/70*
BY: *W.H.M. led*
1cc 836D skcd

RACIAL INT. SECT. *CPH*

5 NOV 20 1970

Buy U.S. Savings Bonds Regularly on the Payroll Savings Plan

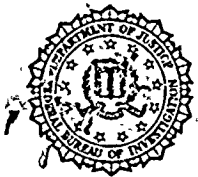

UNITED STATES DEPARTMENT OF JUSTICE

FEDERAL BUREAU OF INVESTIGATION

Cleveland, Ohio

November 5, 1970

In Reply, Please Refer to
File No.

RICHARD CLAXTON GREGORY

The following article concerning the scheduled appearance of RICHARD CLAXTON GREGORY, more commonly known as DICK GREGORY, on the campus at Akron University, Akron, Ohio, on October 16, 1970, appeared in the October 17, 1970 issue of the "Akron Beacon Journal," Akron, Ohio, a daily newspaper of general circulation.

ALL INFORMATION CONTAINED
HEREIN IS UNCLASSIFIED
DATE 1-16-80 BY 2842/er

100-440423-579

ENCLOSURE

White Kids Are New Niggers' — Dick Gregory

By LARRY FIELDS

Back a few years when Dick Gregory was professionally funny rather than professionally furious he wrote his autobiography and titled it "Nigger."

Friday night he appeared at Akron University, courtesy of the Black United Students, and devoted a considerable portion of his talk to plugging the name of his book.

He flung the word "nigger" around so frequently there was the odor of Mississippi—and a Ku Klux Klan convention—at Memorial Hall.

ACCORDING to Gregory, just about everybody except the founding fathers and the white Anglo Saxon Protestants have been "niggers" at one time or another since the Pilgrims first set foot on Plymouth Rock.

About 2,000 persons, equally divided by color and mostly young, crowded the auditorium.

The first "niggers" were, he said, the Indians, who were raped, robbed and murdered by the white man as he bloodily pushed his way from Plymouth to California.

The Indians, Gregory declared in his two-hour list of complaints, were followed by the Irish who he said were so dumb they were made cops.

cause nobody can be that dumb."

PARENTS didn't get off either.

"Remember," Gregory told his youthful audience, "that they voted for Nixon and Agnew."

Even America's founding fathers got verbally slapped.

"They were no heroes," he said. "They were just a bunch of thugs whom the king and queen of England didn't feel like killing so they put them on a boat and sent them away."

"And the damn boat arrived."

IT WAS the beginning of Homecoming Weekend at AU, and as Gregory spoke fire-

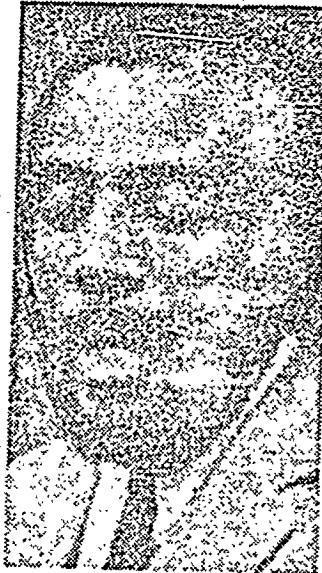

DICK GREGORY

crackers could be heard exploding outside.

Gregory said he now spends about 98 pct. of his time speaking on college campuses. Certainly he must have been paid for Friday's appearance—he is paid for college talks—but how much and from whom is not known. Admission was free.

It is known, however, that the Black United Students at AU are not financially flush.

THE JEWS were next, he claimed, only they were so slick they were permitted to become merchants.

Then there were the Italians. Gregory declared they were given the job of pushing dope.

He said they have what amounts to a governmental carte blanche in the narcotics business.

"Why is it," he asked, "that any 9-year-old ghetto kid can find the heroin man and the FBI can't?"

The blacks, he said, were always "niggers" until about 10 years ago when Stokely Carmichael and Rap Brown changed things.

GREGORY insisted that America has always needed "niggers," and when they lost their grasp on the old reliables they had to find substitutes.

And the replacements were, he said, "middle-class white kids" who discovered their new role in the American scene when four were "murdered" at Kent State University May 4.

THE FORMER funny man attacked the special state grand jury for acquitting the Ohio National Guard for the tragedy at Kent State and indicting 25 students.

"It's not surprising," he said, "because the students are kids and kids are the new 'niggers' and they obviously were guilty because they got in the way of the soldiers' bullets."

Vice President Agnew also came in for some honorable mention.

RE: RICHARD CLAXTON GREGORY

On October 19, 1970, Lieutenant [redacted] [redacted] Akron Police Department, Akron, Ohio, advised that GREGORY's appearance took place as scheduled. GREGORY addressed a group of students, estimated at 2,000 persons. Lieutenant [redacted] stated that there was no incidents, violence or any demonstrative action as a result of GREGORY's appearance on the campus of Akron University.

b6
b7c

This document contains neither
recommendations nor conclusions of
the FBI. It is the property of
the FBI and is loaned to your agency;
it and its contents are not to be
distributed outside your agency.

F.B.I

Date: 11/3/70

Transmit the following in _____
(Type in plaintext or code)

Via AIRTEL _____
(Priority)

Mr. Tolson	_____
Mr. Sullivan	_____
Mr. Mohr	_____
Mr. Bishop	_____
Mr. Brennan	CDN
Mr. Callahan	_____
Mr. Casper	_____
Mr. Conrad	_____
Mr. Felt	_____
Mr. Gale	_____
Mr. Rosen	_____
Mr. Tavel	_____
Mr. Walters	_____
Mr. Soyars	_____
Tele. Room	_____
Miss Holmes	_____
Miss Gandy	_____

PH
PH
PH

TO: DIRECTOR, FBI

FROM: SAC, CINCINNATI (157-NEW)

SUBJECT: SPEECH BY DICK GREGORY,
BELMONT COUNTY CAMPUS,
OHIO UNIVERSITY,
ST. CLAIRSVILLE, OHIO
11/10/70
RM

On 11/2/70, [redacted] (PROTECT) advised that DICK GREGORY will speak at the Belmont County campus of Ohio University, St. Clairsville, Ohio, on Tuesday, November 10, 1970 at 8:30 PM. The speech is open to the public and there is no admission charge.

Arrangements have been made by Cincinnati to cover the speech with sources and Bureau and Chicago will be furnished results.

- 2 - Bureau (RM)
- 2 - Chicago (RM)
- 3 - Cincinnati (2-157-
(1- [redacted])

WG/jei
(7)

EX-111

REC-28 100-440423-578X
157-19494

NOV-55

NOV 12 1970

ALL INFORMATION CONTAINED
HEREIN IS UNCLASSIFIED
DATE 1-16-80 BY 2242/cc

Attended

5

[redacted]

56 NOV 18 1970 Approved: _____
Special Agent in Charge

Sent _____ M Per _____

b6
b7C

b6
b7C
b7D

b7D

b6
b7C

NE 004 PG CODE

1123/ 7:35 PM URGENT 11-10-70 FFP

TO DIRECTOR (100-440423)
(ATTENTION DID)

FEDERAL BUREAU OF INVESTIGATION
COMMUNICATIONS SECTION

NOV 10 1970

FROM PITTSBURGH (157-652)

TELETYPE

RICHARD CLAXTON GREGORY - RM. OO: CHICAGO

Mr. Tolson	_____
Mr. Sullivan	_____
Mr. [unclear]	_____
Mr. [unclear]	_____
Mr. [unclear]	_____
Mr. [unclear]	_____
Mr. [unclear]	_____
Mr. [unclear]	_____
Mr. [unclear]	_____
Miss Gandy	_____

b6
b7C

RE CINCINNATI TELETYPE TO PITTSBURGH, DATED NOVEMBER NINE, SEVENTY, CAPTIONED "SPEECH BY DICK GREGORY, BETHANY COLLEGE, BETHANY, WEST VIRGINIA, NOVEMBER ELEVEN, NINETEEN SEVENTY, RM."

ON NOVEMBER TEN, SEVENTY, [redacted]

b6
b7C
b7D

[redacted] BETHANY, W.VA., ESTABLISHED SOURCE,

ADVISED THAT DICK GREGORY IS SCHEDULED TO SPEAK AT BETHANY COLLEGE, NOVEMBER THIRTY, NINETEEN SEVENTY, AT EIGHT O'CLOCK PM, SPONSORED BY STUDENT BOARD OF GOVERNORS. HE ADVISED GREGORY IS NOT SCHEDULED TO APPEAR ON CAMPUS NOVEMBER ELEVEN, NINETEEN SEVENTY.

ON NOVEMBER TEN, NINETEEN SEVENTY, [redacted]

b6
b7C
b7D

W.VA., A RELIABLE SOURCE, WHOSE [redacted]

END PAGE ONE

ALL INFORMATION CONTAINED
HEREIN IS UNCLASSIFIED
DATE 1-16-80 BY 384/ce

REC-2
100
EX-113

- 440423 580

NOV 12 1970

66 NOV 20 1970

329

RACIAL INT. SECT.

ADVISED GREGORY IS SCHEDULED TO SPEAK NOVEMBER THIRTY,
NINETEEN SEVENTY, AND IS NOT SCHEDULED AT BETHANY, NOVEMBER
ELEVEN, NINETEEN SEVENTY.

IN THE EVENT GREGORY DOES APPEAR NOVEMBER ELEVEN,
NINETEEN SEVENTY, AT BETHANY COLLEGE, APPROPRIATE SOURCE
COVERAGE WILL BE AFFORDED BY PITTSBURGH.

PITTSBURGH, AT PITTSBURGH, PENNSYLVANIA, WILL FOLLOW
AND REPORT GREGORY'S SCHEDULED APPEARANCE AT BETHANY COLLEGE,
ON NOVEMBER THIRTY, NINETEEN SEVENTY.

AIR MAIL COPIES TO CHICAGO AND CINCINNATI .

END

FEDERAL BUREAU OF INVESTIGATION
COMMUNICATIONS SECTION

NOV 9 1970

TELETYPE

- Mr. Tolson _____
- Mr. Sullivan _____
- Mr. Mohr _____
- Mr. Bishop _____
- Mr. Belmont
- Mr. Callahan _____
- Mr. Casper _____
- Mr. Conrad _____
- Mr. Felt _____
- Mr. Gale _____
- Mr. Rosen _____
- Mr. Tavel _____
- Mr. Walters _____
- Mr. Soyars _____
- Tele. Room _____
- Miss Holmes _____
- Sandy _____

NR 001 CI CODE

01220PM

URGENT 11/9/70 CFR

TO DIRECTOR

PITTSBURGH

CHICAGO

FROM CINCINNATI (157-3616) 1P

ALL INFORMATION CONTAINED
HEREIN IS UNCLASSIFIED
DATE 1-16-80 BY 2842/ce

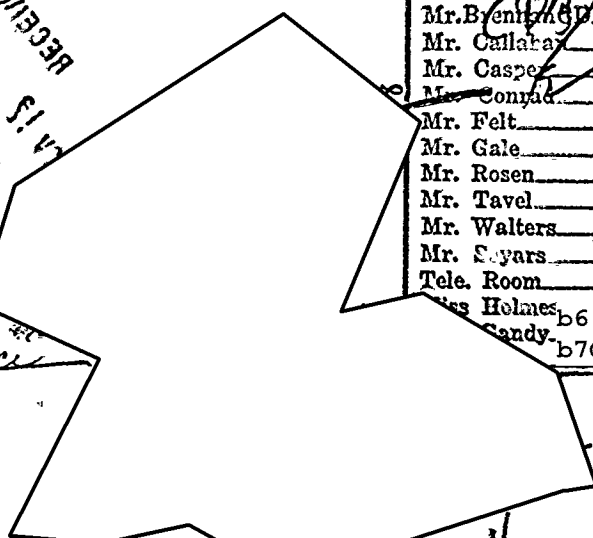

SPEECH BY DICK GREGORY, BETHANY COLLEGE, BETHANY, WEST VIRGINIA
NOVEMBER ELEVEN NINETEEN SEVENTY RM

RE CINCINNATI AIRTEL TO BUREAU NOVEMBER THREE LAST.

FOR INFORMATION PITTSBURGH, GREGORY IS SCHEDULED TO SPEAK AT
BELMONT COUNTY CAMPUS, OHIO UNIVERSITY, ST CLAIRSVILLE, OHIO, DURING
EVENING NOVEMBER TEN NEXT. CINCINNATI COVERING THIS SPEECH THROUGH
SOURCES.

[REDACTED] THIS DATE ADVISED GREGORY WILL SPEAK AT
BETHANY COLLEGE, BETHANY, WEST VIRGINIA, SOMETIME DURING NOVEMBER
ELEVEN NEXT.

PITTSBURGH MAKE ARRANGEMENTS UNDER EXISTING INSTRUCTIONS TO COVER
SPEECH BY GREGORY AT

BETHANY COLLEGE AND FURNISH RESULTS TO BUREAU AND CHICAGO:

END

EJF FBI WASH DC

MR. TRAINOR
ROOM 724 9&D

EX-103

REG-51 100-440423-581

*Shelberg has recording
equip to cover speech*

5- [Handwritten signature]

b7D

FBI

Date: 11/17/70

~~CONFIDENTIAL~~

Transmit the following in _____
(Type in plaintext or code)

Via AIRTEL _____
(Priority)

TO: DIRECTOR, FBI (100-440423)
FROM: SAC, NEW YORK (157-1093)
SUBJECT: RICHARD CLAXTON GREGORY
RM-BN

TDR

Encksd herewith for the Bureau are 14 copies of an LHM regarding captioned subject. One copy each is designated for Legats London and Rome for their information. ~~(U)~~

Gregory's activities in front of the UN were observed by SAs JOHN FRANCIS MAHER, RAYMOND MOHR and _____

NYO has no Bureau approved characterization of the National Coalition Against War, Racism, Repression.

1-16-80
CLASS. & EXT. BY 2842 pvd/cj
REASON-FCIM II, 1-2.4.2.2
DATE OF REVIEW 11-17-90

- 5 - Bureau (Encls. 14) (RM)
 - 1 - Legat London
 - 1 - Legat Rome (157-22)
 - 1 - Foreign Liaison Desk
- 1 - Chicago (157-347) (Encl. 1) (RM)
- 1 - New York

~~(U)~~

EX-115

REC-76

100-440423-382

NOV 18 1970

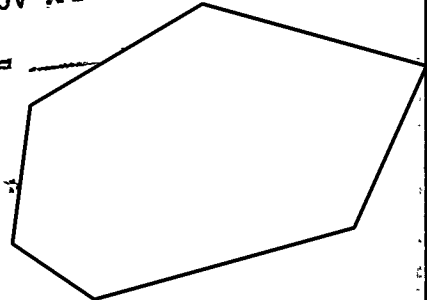

AGENCY: ICDSO, SEC. SERV., AIRTEL, IDIU, DEPT. ISD, ROME, RON, DON
HOW FOR: *CC 836 AB*
DATE FORW: *11/19/70*
BY: *CE E. [unclear]*

NOV 30 1970

Approved: _____
Special Agent in Charge

Sent _____ M Per _____

~~CONFIDENTIAL~~

b6
b7C

b6
b7C



UNITED STATES DEPARTMENT OF JUSTICE

FEDERAL BUREAU OF INVESTIGATION

New York, New York

November 17, 1970

In Reply, Please Refer to

File No.

Bu 100-440423

NY 157-1093

Richard Claxton Gregory

On November 16, 1970 at 11:00 PM, 25 persons including Richard Gregory entered the United Nations Building at New York City, New York, protesting the "genocide practices of the United States Government".

The group left the United Nations Building at 11:45 PM and held a Press Conference across the Street from the United Nations between 42nd and 43rd Streets.

Gregory was one of three persons who spoke at the Press Conference. He remarked that the group on Saturday (November 21, 1970) will be larger and the demonstration at the United Nations from 2:00 - 4:00 PM that date will be for the purpose of letting the public know of the genocide policy of the United States Government against the Blacks, Puerto Ricans and other minority groups.

This document contains neither recommendations nor conclusions of the FBI. It is the property of the FBI and is loaned to your agency; it and its contents are not to be distributed outside your agency.

ALL INFORMATION CONTAINED
HEREIN IS UNCLASSIFIED
DATE 1-16-80 BY 2842/ci

ENCLOSURE

100-440423-582

Richard Claxton Gregory

The above activities were sponsored by the National Coalition Against War Racism Repression.

About 50 persons attended the Press Conference including the Press, Radio and Television media.

FBI

Date: 11/17/70

Transmit the following in _____
(Type in plaintext or code)

Via AIRTEL _____
(Priority)

To: Director, FBI ATTENTION:

From: SAC, CINCINNATI (157-3720) CIVIL RIGHTS SECTION
(RUC) GENERAL INVEST. DIV.

Subject: SPEECH BY DICK GREGORY, DOMESTIC INTELLIGENCE DIV.
BELMONT COUNTY CAMPUS, OHIO UNIVERSITY, ST. CLAIRSVILLE, OHIO,
NOVEMBER 10, 1970

ALL INFORMATION CONTAINED
HEREIN IS UNCLASSIFIED
DATE 1-16-80 BY 2842 P/W/c

- CR EL DIH CRA-64
- BM BM-Threats Racial Matters PA PE PF E

Re CI airtel to Bu, 11/3/70; Klan Organization
CI tel to Bu, 11/9/70.

Summary of Complaint:

Enclosed for the Bureau are eight copies of an LHM captioned as above, suitable for dissemination.

Enclosed for Chicago are two copies of above LHM and one copy of LHM is enclosed for the information of Pittsburgh.

LHM is being disseminated to U.S. Secret Service, 109th MIG, NISO, USA, all Columbus, Ohio; and OSI, Dayton, Ohio.

The first confidential source mentioned in LHM is [redacted] contacted by SA [redacted]

ACTION: UACB:

- 2-Bureau (Enc. 1) No further action being taken and (RM) LHM enclosed Copy furnished to USA, Columbus, Ohio.
- 2-Chicago (Enc. 2) (RM) FD-376 (enclosure to LHM)
- 1-Pittsburgh (Enc. 1) LHM being submitted (Info) (RM)
- 4-Sincinnati (157-3720) Report being submitted
- (1- [redacted]) Preliminary investigation instituted
- (1- [redacted]) Limited investigation instituted

9 NOV 20 1970

b6
b7C
b7D

ENCLOSURE

Sent _____ M Per _____

Special Agent in Charge

AGENCY: ICDSO, DEPT: ISD, DEPT: IDIU, DEPT: SEC, DEPT: BIRN, DEPT: [redacted]
HOW FORW: [redacted]
DATE FORW: 11-23-70
BY: CEF

R-200

507msw 1 1970
(8) Approved: _____

CI 157-3720

The second confidential source is [REDACTED]
[REDACTED] contacted by SA [REDACTED]

b6
b7C
b7D

LHM is being classified confidential because it contains information from confidential sources, the disclosure of whom could jeopardize their future effectiveness and be injurious to the security interest of the U.S.



UNITED STATES DEPARTMENT OF JUSTICE

FEDERAL BUREAU OF INVESTIGATION

Cincinnati, Ohio
November 17, 1970

In Reply, Please Refer to
File No.

~~Confidential~~

RE: SPEECH BY DICK GREGORY,
BELMONT COUNTY CAMPUS,
OHIO UNIVERSITY,
ST. CLAIRSVILLE, OHIO,
NOVEMBER 10, 1970

A first confidential source, who has furnished reliable information in the past, advised that Dick Gregory spoke at the Belmont County Campus, Ohio University, St. Clairsville, Ohio, on November 10, 1970. Gregory's speech started at approximately 8:30 PM and lasted until 11:15 PM. The speech was attended by approximately 400 people. Gregory's talk centered on politics, the police, the ghetto areas, hunger in America, Black Nationalists, and persecution of minority groups. Throughout his speech Gregory kept stating, "You youngsters have a big job ahead of you; we adults have left you a terrible mess."

The following in essence are quotes and other statements made by Gregory during his speech:

Gregory stated his speech by telling stories about President Nixon and Vice President Agnew in which he stated that Nixon goes abroad "hugging the fascists" and "Agnew is the type of cat who would make a crank call to the Russians on the hot line."

He stated that man has created the problems that our nation is facing and it is up to the young people to solve them. The problems can be solved by ethical, not "strong arm" means, as the "great men" in Washington think. "Politicians should not campaign on a law and order issue." "Let's not talk about law and order; let's talk about bread and butter." "Fortyfour million people in America go to bed hungry every night." There is more dog food sold

~~Confidential~~

GROUP I

Excluded from automatic downgrading
and declassification

ALL INFORMATION CONTAINED
HEREIN IS UNCLASSIFIED
DATE 1-16-80 BY 2842 PVD/CA

100-440423-582X

ENCLOSURE

157-19494-2

SPEECH BY DICK GREGORY,
BELMONT COUNTY CAMPUS,
OHIO UNIVERSITY,
ST. CLAIRSVILLE, OHIO,
NOVEMBER 10, 1970

~~Confidential~~

in the supermarkets near low income housing than anywhere else, and no dogs are allowed in low income housing. More people than dogs are eating dog food. "Freaks talk about law and order while people go hungry. Check out your own home; your parents put Nixon in office. You should not be able to walk down the street safely while people are starving. When I become afraid and hungry it is my basic right to react."

"When I was a boy you made me want to get to your white girls by your movies and advertisements. We never saw a shapely colored girl used in advertisement. The only thing we ever saw were slurred "ads" such as Aunt Jemima and Uncle Ben."

"At age nine I knew every pimp, whore, and dope peddler in the area, but the police and the FBI can't even locate them." Most police are too busy making "shake downs" to see what's going on. My children see the prostitutes soliciting right on the street with a cop standing right there. You send me the cop from your neighborhood and I'll send you my ghetto cop and we'll see how fast you send him back. Give us black cops in black areas so we can see how he lives and what he is doing off duty. That way we can control him."

"You never read where a white pimp or dope peddler was shot in bed like the Black Panthers. Double barrel shotguns are outlawed in war as being inhumane, but our police are allowed to use them on Black Panthers and you college kids. You never hear the President or the big politicians say something should be done about the dope peddlers, but they sure do talk about the Black Panthers and college kids. Police and National Guardsmen shoot Panthers and college kids. People's property rights cannot be placed ahead of human rights. If the government thinks it can stop a revolution with the National Guard, it has another thought coming. What's going on is nature's way

~~Confidential~~

SPEECH BY DICK GREGORY,
BELMONT COUNTY CAMPUS,
OHIO UNIVERSITY,
ST. CLAIRSVILLE, OHIO,
NOVEMBER 10, 1970

~~Confidential~~

of warning you that you had better do something or something is going to happen."

"There is no generation gap. The older people know what you are talking about and they don't want to listen. They paid the price to make alcohol a symbol of manhood, and now they don't want you to have 'reefers.' Morality scares older people and repression is a reaction of this fear. Parents put down kids, not build them up."

"You must understand where and how this country was started and where she is going. It was started by a bunch of 'cut throats' that escaped from England. Our country was stolen from England by the 'cut throats' and is still being run by 'cut throats.' It is your duty to correct the government when it steps out of bounds. The Constitution of the United States gives you that right."

"The United States is the only country in the world's history to start cowboys and Indians. The 'great white father' first started with the Indians. When the Indians did not want to play Indian any more, they put him on reservations. Next the 'great white father' told the Jew to be the Indian. When the Jew did not want to be the Indian any longer, the 'great white father' said, 'Jew what do you want to be?' The Jew said, 'I'll think it over,' and he is still thinking. Then the Irishman became the Indian. When the Irishman no longer wanted to play the Indian, the 'great white father' said, 'What do you want to be?' The Irishman said, 'I want to be a cop,' and the 'great white father' made him a cop because the Irishman is so dumb. Then the Italians became the Indians and when they no longer wanted to be the Indians, the 'great white father' made them the pimp, and dope peddler, and formed the Mafia which their 'great white father' controls. Then the Negro became the Indian and, when the Negro wanted to stop playing Indian, the 'great white father' reacted and this caused all of the disturbances in the 1960's. The 'great white father' is actually the father of all and he shoots his own sons instead of helping them. The 'great white father' owns the police and they have the master plot. They don't want the Indians to have guns."

~~Confidential~~

SPEECH BY DICK GREGORY,
BELMONT COUNTY CAMPUS,
OHIO UNIVERSITY,
ST. CLAIRSVILLE, OHIO,
NOVEMBER 10, 1970

~~Confidential~~

"This thing called education is making people dumb. Schools and colleges only teach you what they want you to know."

"May 4, 1970, at Kent State is when the 'great white father' picked other 'Indians and niggers,' you college kids. He shot four of them. Two hundred years ago in 1770 the British shot four in Boston and they were throwing snowballs. Look at what happened between 1770 and 1776. Ask the Indians, they know. Watch out from 1970 to 1976, because history repeats itself."

"If democracy is so 'damn' good, why do we go all over the world trying to sell it to others?"

"We can do something about the National Guard. If everyone boycotted Christmas, the Sears and Roebuck Company would put enough pressure on the 'great white father' to do away with the National Guard. You must act right now and do something before Thanksgiving."

"You've got a big job, America is worth saving. The answer is not guns or dynamite, your strength is in your great moral force."

A second confidential source, who has furnished reliable information in the past, attended the speech by Dick Gregory on November 10, 1970, and furnished essentially the same information as the first confidential source. The second confidential source said that Gregory also made the following statements during the course of his speech:

Gregory stated the Black Panthers were shot and killed because they bring food to the hungry children in the ghetto areas. He said there was much publicity and continues to be much publicity about the shooting of four Kent State students, but little has been said about the killing of two black students at Jackson State in Jackson, Mississippi.

~~Confidential~~

~~Confidential~~

SPEECH BY DICK GREGORY,
BELMONT COUNTY CAMPUS,
OHIO UNIVERSITY,
ST. CLAIRSVILLE, OHIO,
NOVEMBER 10, 1970

Gregory said that Stokely Carmichael and Rap Brown have taught the Negro one good lesson and that is be natural and stop imitating the whites.

He said that one day the young people are going to have to write history. Most of the "old fools" do not understand what we keep telling mama (America). We keep telling mama that she is sick and we want to help her, but she does not listen.

He said there are a lot of questions for the young people to ask. If democracy is so good, why do we go all over the world trying to ram it down the throats of other people? Why don't the other people come begging for it? The fate and destiny of America is in the hands of the young people. He said the answer is not in dynamite and guns, but in the great moral force of the young people which is the only thing that scares America.

Both sources commented that throughout the speech Gregory used very profane and at times what they considered to be obscene language.

Further information concerning Carmichael and Brown of the Student National Coordinating Committee and the Black Panther Party is attached hereto.

~~Confidential~~

00 00

A P P E N D I X

~~CONFIDENTIAL~~

1

STUDENT NATIONAL COORDINATING COMMITTEE

A source advised the Student National Coordinating Committee (SNCC), formerly known as the Student Nonviolent Coordinating Committee, is a nonmembership organization founded in 1960, during the civil rights movement in the South.

Under the leadership of Stokely Carmichael, who served as National Chairman during the period 1966-67, SNCC evolved from a civil rights oriented group into a full-blown black revolutionary organization.

A publication entitled, "1967, High Tide of Black Resistance" indicates the year 1967 was considered by SNCC as a historic milestone for the liberation of black people in the United States and the year that revolutionaries throughout the world began to understand more fully the impact of the black movement. The publication declared that "liberation will come only when there is final destruction of this mad octopus--the capitalistic system of the United States with all its life-sucking tentacles of exploitation and racism that choke the people of Africa, Asia, and Latin America. The realities of black life, together with the recognition instilled in SNCC workers, forced its members to further popularize the legitimacy of self-defense and rebellions when oppression became too great."

A second source advised that H. Rap Brown succeeded Carmichael as National Chairman of SNCC in May, 1968, and served in that capacity until June, 1968, at which time SNCC reorganized, creating ten deputy chairmen in an effort to relieve pressure by law enforcement.

In April, 1969, SNCC moved its national headquarters from Atlanta, Georgia, to New York City, where it is presently located.

H. Rap Brown announced at a press conference in New York City on July 22, 1969, that he had been elected Chairman of the Student Nonviolent Coordinating Committee. He announced the organization was dropping the word "Nonviolent" from its title, and will be known as the Student National Coordinating Committee, with a Revolutionary Political Council functioning as its governing body. Brown, at that time, stated the use of force is necessary in obtaining revolutionary goals.

~~CONFIDENTIAL~~

~~CONFIDENTIAL~~

A P P E N D I X

BLACK PANTHER PARTY (BPP),
ALSO KNOWN AS
BLACK PANTHER PARTY FOR SELF DEFENSE

According to the official newspaper of the BPP, the BPP was started during December, 1966, in Oakland, California, to organize black people so they can take control of the life, politics, and the destiny of the black community. It was organized by BOBBY G. SEALE, BPP Chairman, and HUEY P. NEWTON, Minister of Defense, BPP.

The official newspaper, called "The Black Panther," regularly states that the BPP advocates the use of guns and guerrilla tactics in its revolutionary program to end oppression of the black people. Residents of the black community are urged to arm themselves against the police who are consistently referred to as "pigs" who should be killed.

The newspaper, in its issue of September 7, 1968, had an article by the then Minister of Education, GEORGE MURRAY. This article ended with the following:

"Black men. Black people, colored persons of America, revolt everywhere! Arm yourselves. The only culture worth keeping is revolutionary culture. Change. Freedom everywhere. Dynamite! Black power. Use the gun. Kill the pigs everywhere."

The BPP newspaper, issue of October 5, 1968, had an article introduced with the following statement: "We will not dissent from American government. We will overthrow it."

DAVID HILLIARD, Chief of Staff, BPP, in a speech at the San Francisco Polo Field on November 15, 1969, said "We will kill RICHARD NIXON."

DAVID HILLIARD, in the "New York Times," issue of December 13, 1969, was quoted as follows: "We advocate the very direct overthrow of the government by way of force and violence."

In the issue of April 25, 1970, the BPP newspaper had an article by Minister of Culture EMORY DOUGLAS as follows:

~~CONFIDENTIAL~~

~~CONFIDENTIAL~~

APPENDIX
RE: BPP.

2

"The only way to make this racist US government administer justice to the people it is oppressing, is...by taking up arms against this government, killing the officials, until the reactionary forces...are dead, and those that are left turn their weapons on their superiors, thereby passing revolutionary judgement against the number one enemy of all mankind, the racist U.S. government."

The BPP Headquarters is located at 1046 Peralta Street, Oakland, California. Branches of the BPP and Committees to Combat Fascism, under control of the BPP, have been established in various locations in the USA.

~~CONFIDENTIAL~~

THIS DOCUMENT CONTAINS NEITHER RECOMMENDATIONS NOR CONCLUSIONS OF THE FBI. IT IS THE PROPERTY OF THE FBI AND IS LOANED TO YOUR AGENCY IT AND ITS CONTENTS ARE NOT TO BE DISTRIBUTED OUTSIDE YOUR AGENCY.

f*

GSA FPMR (41 CFR) 101-11.6

UNITED STATES GOVERNMENT

~~CONFIDENTIAL~~

Memorandum

TO : DIRECTOR, FBI (100-440423)

DATE: 11/25/70

FROM : SAC, CHICAGO (157-347) (P)

SUBJECT: RICHARD CLAXTON GREGORY, aka
RM-BN

File

OO: CHICAGO

Enclosed for the Bureau are 11 copies of LHM, dated and captioned as above. No local disseminating being made, so as to preclude the possibility of pinpointing this source.

Source is [redacted] and he has been targeted to develop information regarding information reported in this Letterhead Memorandum (LHM). (U)

b7D

This LHM being classified confidential to further protect the identity of this source, who is of continuing value.

V

AGENCY: ICDSO, ~~ISD~~, ~~OSI~~, SEC. SERV., ~~IRS~~, CIA, STATE
DEPT: ISD, ~~CRD~~, IDIU, ~~CO~~

HOW FORW: As
DATE FORW: 12/1/70
BY: CE/ld
rec 836D

CLASS. & EXT. BY 2842 PK/cw
REASON-FCIM, II, 1-2.4.2 2
DATE OF REVIEW 11-25-90

*12/1/70 0-7 for info to Dept of Justice
Mailed w/ 1cc LHM for each
office. COT lead*

↓

EX-115

REC-3

- 2 - Bureau (RM) (Encls. 11) ENCLOSURE
 - 2 - Chicago
 - 1 - A [redacted]
- HHS:svw
(4)

100-440423-583

b7D

NOV 27 1970

APPROPRIATE AGENCIES AND FIELD OFFICES
ADVISED BY ROUTING SLIP ON 2-8-80 jcb



54 DEC 7 1970

Buy U.S. Savings Bonds Regularly on the Payroll Savings Plan

~~CONFIDENTIAL~~
RACIA



UNITED STATES DEPARTMENT OF JUSTICE
FEDERAL BUREAU OF INVESTIGATION

~~CONFIDENTIAL~~

In Reply, Please Refer to
File No. 157-347

CHICAGO, ILLINOIS
NOV 25 1970

ma
~~RICHARD CLAXTON GREGORY,~~
ALSO KNOWN AS
DICK GREGORY

~~CONFIDENTIAL~~

On November 10, 1970, a confidential source, who has furnished reliable information in the past, advised that Dick Gregory planned to travel in the near future to Morocco to prepare himself "spiritually and physically" for a fast, which he plans to conduct at St. Paul Cathedral, London, England, during the period between Christmas and New Year. ~~(U)~~

Gregory is an American citizen; by profession a comedian, who is a self appointed political activist and human rights advocate.

Gregory's fast will be his method of expressing opposition to the sale of arms to the government of South Africa, by both the British and United States of America governments. ~~(U)~~

Travelling with Gregory will be though no information is available to indicate that she might be planning to demonstrate for any cause. ~~(U)~~

b6
b7c

R. Gregory

1-16-80
CLASS. & EXT. BY 2842 PVD/cu
REASON-FCIM II, 1-2.4.2 2
DATE OF REVIEW 11-25-90

~~CONFIDENTIAL~~
Group 1
Excluded from Automatic
Downgrading and
Declassification

APPROPRIATE AGENCIES AND FIELD OFFICES ADVISED BY ROUTING SLIP ON 7-8-80

This document contains neither recommendations nor conclusions of the FBI. It is the property of the FBI and is loaned to your agency; it and its contents are not to be distributed outside your agency.

~~CONFIDENTIAL~~

100-440423-583

ENCLOSURE

FBI

Date: 11/30/70

Transmit the following in _____
(Type in plaintext or code)

Via AIRTEL _____
(Priority)

b6
b7C

EDM
TO: DIRECTOR, FBI
FROM: SAC, PITTSBURGH (157-652) (P)
SUBJECT: RICHARD CLAXTON GREGORY, aka
RM

Enclosed for the Bureau are eight copies and for Chicago two copies of an LHM pertaining to captioned subject.

Source mentioned in LHM is _____
_____ Waynesburg College, Waynesburg, Pa. (established source).

b6
b7C
b7D

Information in the LHM was furnished to SA WAYNE MORSE.

- 3-Bureau (Encs. 8) (RM)
- 2-Chicago (Encs. 2) (RM)
- 2-Pittsburgh

8 ENCLOSURE

WM/sjb
(7)

ALL INFORMATION CONTAINED
HEREIN IS UNCLASSIFIED
DATE 1-16-80 BY 2842/cj

EX-116

REC-32

100-440423-587

AGENCY: ~~DECS~~, ~~SEC~~, ~~SEC~~, ~~SERV.~~
DEPT: ~~...~~ IDIU, ~~...~~
HOW FORW: RB
DATE FORW: 12-4-71
BY: WHA ... C.R.D.

4 DEC 2 1970

b6
b7C

53 Approved: 1-1-1971
Special Agent in Charge

Sent _____ M



UNITED STATES DEPARTMENT OF JUSTICE

FEDERAL BUREAU OF INVESTIGATION

Pittsburgh, Pennsylvania

November 30, 1970

RICHARD CLAXTON GREGORY

In Reply, Please Refer to
File No.

On November 25, 1970, a source, who has furnished reliable information in the past, advised that on November 22, 1970, Richard Gregory spoke at Waynesburg College, Waynesburg, Pennsylvania, under the auspices of the college. This source related that Gregory received a fee of \$1,000 for his appearance and speech at this college.

The source further related that the appearance of Gregory was attended by approximately 400 people, which was estimated to be 300 students and members of the faculty and approximately 100 persons who were residents from the Waynesburg area. Gregory spoke for approximately two hours and appeared to have a well-prepared speech, and the source advised that he was sure it had been repeated many times.

The source related that there were no outside incidents and no reactions, one way or another, to his appearance by the community and that they had accepted him as a critic and a comic.

The source advised that Gregory made excuses for the activities of the Negro people and at times appeared to be vindictive, stating that the Negro had been so oppressed and had been put down for such a long period of time, that his activities were excusable. The source advised that this talk was sprinkled with humor, no rabble rousing, and was fairly well received by those in attendance.

The source advised that after the speech there was a question-and-answer period which lasted for about an hour, and the results were exceptional with good response by Gregory to all questions put to him. Gregory related that his role is that of a social critic, and he could not furnish any answers to the social problems existing in the United States today.

This document contains neither recommendations
nor conclusions of the FBI. It is the property
of the FBI and is loaned to your agency; it and
its contents are not to be distributed outside
your agency.

ALL INFORMATION CONTAINED
HEREIN IS UNCLASSIFIED
DATE 1-16-80 BY 2842/CLM/agency.

100-446423-684
ENCLOSURE

F B I

Date: 12/4/70

Transmit the following in _____
(Type in plaintext or code)

Via AIRTEL _____
(Priority)

To : DIRECTOR, FBI
From : SAC, PITTSBURGH (157-652) (RUC)
Subject: RICHARD CLAXTON GREGORY, aka
RM

CR

Ward

4

Enclosed for the Bureau are eight copies and for Chicago two copies of an LHM pertaining to captioned subject.

Source mentioned in LHM is [redacted] (Established source)

b6
b7C
b7D

Information in the LHM was furnished to SA [redacted]

- 2 - Bureau (Enc. 8) (RM)
- 2 - Chicago (Enc. - 2) (RM)
- 1 - Pittsburgh
- TFB/nju
- (5)

ENCLOSURE

ALL INFORMATION CONTAINED
HEREIN IS UNCLASSIFIED
DATE 1-16-80 BY 2842/ce -116

Att. [Signature]

REC-77

100-440423 585

AGENCY: ~~DO, MO, OS~~ SEC: ~~SERV.~~
DEPT: ~~IDIU, SD~~

HOW FORM: RS
DATE FORW: 12-9-70
BY: CEE jpp 5.ccd

DEC 7 1970

b6
b7C

ROUTING UNIT *R10/98*
ERROR LETTER SENT *2-70*

Approved: 770 Special Agent in Charge Sent _____ M Per _____

53 DEC 16 1970



UNITED STATES DEPARTMENT OF JUSTICE

FEDERAL BUREAU OF INVESTIGATION

In Reply, Please Refer to
File No.

Pittsburgh, Pennsylvania

December 4, 1970

RICHARD CLAXTON GREGORY

On December 1, 1970, a source who has furnished reliable information in the past advised that on November 30, 1970, Richard Gregory spoke at Bethany College, Bethany, W. Va., under the auspices of the College, namely, the Student Board of Governors.

The source advised that Gregory spoke at the College fieldhouse before an estimated audience of 1,000, comprised mainly of students from Bethany and surrounding colleges and faculty of same. Gregory spoke from 8:30 p.m., until 10:30 p.m., and appeared to have a well-prepared speech. The source related that there were no outside incidents and little reaction, one way or another, to his appearance, and that his remarks, for the most part, seemed to be accepted in the vein of a vaudeville performance.

Source noted that Gregory's speech centered on persecution of minority groups, politics, law enforcement, the ghetto areas in America, social ills and black nationalists.

Gregory began his speech by pointing ridicule at the current Administration, relating that if President Nixon claimed a victory of the recent elections, all he would need would be two similar victories and he wouldn't have any party left.

This document contains neither recommendations nor conclusions of the FBI. It is the property of the FBI and is loaned to your agency; it and its contents are not to be disseminated outside your agency.

ALL INFORMATION CONTAINED
HEREIN IS UNCLASSIFIED
DATE 1-11-80 BY 2842/ce

ENCLOSURE

100-440423-585

RICHARD CLAXTON GREGORY

Gregory then talked of right wing newspapers and how they were labeling college students as rabble rousers.

Gregory then turned to attack on law enforcement, citing the stupidity of the practice of using white policemen in the ghetto area. He advised that the white police were getting paid off in the ghetto area and recalled that when he was five years old, he knew the identities of the pimp and dope peddler when the white policemen were unaware of these identities.

Gregory recalled World War II and advised that the United States Government was racist because the bomb was dropped on Japan instead of Germany simply because the Germans were white. He compared this to the present times, saying that the United States would rather fight with the Vietnamese than with the Russians because the Russians are white. He related that if an African nation were supplying arms to the Viet Cong, the United States would wage war on the African nation.

Gregory stated that revolution was controlled by evolution; that it can't be stopped and has to happen. He recalled colonial days, describing the Pilgrims as a group of cutthroats who were placed on a ship because the queen thought it was going to sink. He said the Boston Tea Party was no more than the riots in the ghettos and should not be publicized by racists who write textbooks. Gregory explained that since colonial days, the United States Government has had to have an "Indian." He noted that after the American Indian, the Irishman became the Indian, and he eventually became a policeman because he was so dumb. Then came the Italian, who later formed the Mafia. Then came the Jews, who became the merchant society, and then the Negroes. Gregory at this point pointed his finger at the audience and stated that now the college students are the "niggers."

He stated that the Kent State incident was like a mother giving birth to a child and that no matter how many troops from the National Guard were to be called in, the mother would still give birth. He talked of the drug problem and compared it with the alcohol used by the parents of dope users.

RICHARD CLAXTON GREGORY

Regarding the black nationalists, he spoke of how white people are appalled by the fact that the minority group uses weapons. He stated that if the whites had to grow up in the ghetto area, they wouldn't think twice about using guns. He spoke of the free food program being sponsored by the black nationalist groups and pointed to how dog food was being consumed by a large populace in certain ghetto areas. Gregory commented on the absurdity of politicians campaigning on a law and order issue when, in fact, people were starving in the ghetto areas.

The source concluded that Gregory's speech, sprinkled with humor and, on many occasions, profanity, appeared to be well received by those in attendance. Source stated that Gregory had expressed his views on what he considered to be deficiencies in our country, but had not formulated any opinion as to how these ills could be corrected.

UNITED STATES GOVERNMENT

Memorandum

~~CONFIDENTIAL~~

TO : DIRECTOR, FBI (100-440423)

DATE: 12/4/70

FROM : SAC, NEW ORLEANS (157-6951) (RUC)

SUBJECT: RICHARD CLAXTON GREGORY, aka
RM
OO: CHICAGO

APPROPRIATE AGENCIES AND FIELD OFFICES
ADVISED BY ROUTING SLIP ON 2-8-80 *out.*

Re New Orleans airtel to Bureau, ^{See 524} 2/11/70.

Enclosed for the Bureau are five copies of an LHM dated and captioned as above reflecting the contents of a speech given by the subject at McAllister Auditorium on the campus of Tulane University on 11/12/70.

Enclosed for Chicago are two copies of same LHM.

Contents of speech contained in LHM were furnished to the New Orleans Division by [redacted]

[redacted] (U)

b6
b7C
b7D

LHM has not been classified confidential, inasmuch as the auditorium was completely filled, and identification of informant could not result from contents contained in LHM.

- ② - Bureau (Enc. 5) (RM)
- 2 - Chicago (Enc. 2) (RM)
- 2 - New Orleans
 - (1 - 157-6951)
 - (1 - [redacted])

WAM = smj
(6)

ENCLOSURE

1-16-80
CLASS. & EXT. BY 2842 p/w/c
REASON-FCIM II, 1-2.4.2.2
DATE OF REVIEW 12-4-90

b7D

REC-54 Ex-116

100-440423-586

DEC 14 1970

AGENCY: ICDSO, ~~WFO, OSE~~ SEC: 'SERV., ~~RES~~
DEPT: ISD, ~~CRD~~, IDIU, ~~ED~~
HOW FORW: RS
DATE FORW: 12-18-70
BY: RUC

~~CONFIDENTIAL~~

66 DEC 21 1970

~~CONFIDENTIAL~~



UNITED STATES DEPARTMENT OF JUSTICE
FEDERAL BUREAU OF INVESTIGATION

New Orleans, Louisiana
December 4, 1970

In Reply, Please Refer to
File No.

RICHARD CLAXTON GREGORY

On November 13, 1970, a source, with whom contact has been insufficient to determine reliability, advised that on November 12, 1970, Dick Gregory spoke at McAllister Auditorium on the campus of Tulane University, New Orleans, Louisiana. Source reported that the auditorium was almost filled to capacity for the speech; and the following are salient parts and quotations from the speech:

Gregory first spoke about how the United States Government first developed. He stated that the people who arrived at Plymouth Rock were outcasts from Europe, but they did not discover a country that was not already occupied. These people started killing the red men (or Indians) and, when the people (or cowboys) could not rule the Indians, they got the dumb Irishmen to become the cops, and the Italians to be the Mafia. The cowboys (or Government) used the Irishmen as the police and the Mafia as a Syndicate, and with the protection of the Government, the police and the Mafia became drug dealers.

As time went on, the Government, police, and the Mafia became one. As the red men disappeared, they still needed Indians, so they later turned on the Negro or black man. As time passed, the Negro got tired of being killed and misused and not being able to live like other people of this country. Gregory stated that, as a result, the Central Intelligence Agency (CIA) and Government has gotten rid of all of the Negro leaders, such as Martin Luther King, Stokely Carmichael, and Rap Brown. He also claimed that Jim Garrison,

This document contains neither recommendations nor conclusions of the FBI. It is the property of the FBI and is loaned to your agency; it and its contents are not to be distributed outside your agency.

ALL INFORMATION CONTAINED
HEREIN IS UNCLASSIFIED
DATE 1-16-80 BY 2842/ce

100-440423-586
ENCLOSURE

the New Orleans District Attorney, is being killed in some way because he was trying to open the people's eyes about the Kennedy assassination.

Gregory stated that it will not be long before there will be a change in this Government but that it should not be by bombings since this would be worse than doing what the outcasts who first came to this country did.

Gregory then stated that it is a shame that 44 million people have to go to bed hungry each night while this Government sends money all over the world. Gregory said that, when he was fasting for some thirty odd days while in jail, he was watching TV, and a commercial came on about dog food. He stated that all at once the dog food looked so good to him. He said the dog was wagging his tail, and he (Gregory) began to wag his own tail. He thought suddenly about how much dog food is being sold in the major metropolitan cities and about the 44 million people who were going to bed hungry each night. Gregory stated he called in fifteen researchers and determined that most of the dog food was being sold in the low income areas and around the Government housing project areas in large cities. "At the price of \$.10 a can, brother, you had better look out if you are asked out for a hash dinner because you could be eating dog food."

Gregory also mentioned how much money a United States Senator has to spend to try and get elected. "Why in the hell would any man spend two million dollars to receive what he does? You've got to be kidding!" He went on to say "You young people have a lot of work ahead of you, and it is going to be tough sliding, not because of the generation gap but because you young people are defying the old ways."

Gregory mentioned the Kent State killings and how an innocent girl was killed along with an honors student who was in the Reserve Officers' Training Corps (ROTC). Then some people in the auditorium shouted "Right on, right on," and then arm signals were given of the power sign. He also

said that, when people try to do some good, they are shot down. It was the same way in 1770 when the British had control, and the people stood up against them. He kept on saying "You have a big job ahead of you."

Gregory said, "If you don't wake up soon, you will find yourselves in a bigger mess than the Negro was in, but the Negro is going to do something about it, and it isn't long off. The Negro has come a long way since 1960 and, baby, we are tired of this shit. You take care of the whites, and let us take care of the blacks. You whites are afraid of the Black Panthers. We're not. We love them. When a white cop comes in our neighborhood, he's only there for an eight hour duty and then goes home. If he should kill some little boy in our neighborhood, it's okay. But if this should be a Negro cop and he lives in our locked Negro neighborhood, we could take care of the situation. This cop may be in one of our black barber shops getting a haircut and a shave. While the barber was putting the shaving cream over the face and putting the razor next to him to shave him, I walk in and ask him why he killed our sons. It's a damn shame we can't have it this way."

Gregory went on to say "You had better do something about it, you cats. It has to be soon and before 1976. If you wish to make a go of it, we have to change it all. If we had black people in power, such as the President and such, it would be different. We're tired of this shit."

He said "You white people have indoctrinated us to believe that the whites were gods, that they never did anything wrong. You put your TV trash in our living rooms. You put your Miss America in our living room as a beautiful thing, but when a Negro man puts his hands on these beautiful white things, they are hit in the head or killed. It was all right for the white cops or pimps to use the Negro woman. Nothing was done about that."

Gregory said that, when he was five years old, he saw how the prostitutes were paying off the cops and how he or any young fellow could buy dope, but the FBI could not

find these pushers or dealers because of the city Government. He said his father was killed in 1942 by a German, and after the war a German could come to this country and move right next door to the "U.S. cat," but when a Negro wanted to, he was told to "get the hell out." So why should not the Negro get mad since he was born in this country.

At the end of the speech, Gregory sent his regards to Jim Garrison and wished him all luck in surviving whatever was wrong with him.

- Tolson
- DeLoach
- Walters
- Mohr
- Bishop
- Casper
- Callahan
- Conrad
- Felt
- Gale
- Rosen
- Sullivan
- Tavel
- Soyars
- Tele. Room
- Holmes
- Gandy

Here he is, Folks, Dick Gregory: Fizz, crackle, zap, ba-room

By ~~PETER~~ COUTROS *43*
U.S.

WORDS, WORDS, WORDS tumble from his lips, incessantly moving lips, as though a dictionary had imploded within him and he was now spewing forth nouns and verbs and double that in adjectives and adverbs. The words became sentences, the sentences paragraphs and the paragraphs parthenogenetically evolve into exhortations, harangues, stretches of wit and lengthier tracts of rage.

More simply, it is Dick Gregory, middle name Claxton, doing his thing; his very own, peculiar-to-him thing.

Usually, he plies his tirade before crowds of young people, on one-nighters before collegians two decades younger than his 38 years, or in such subterranean sauce-mills as the Village Gate, where he was seen last week.

Records are another of his media, with a four-sided album, "The Light Side, the Dark Side," emerging as one of the big hits on the charts. His autobiographical "Nigger!" was well-received by book reviewers.

But the essential Dick Gregory is sharpest in person. Either in a roomful of anti-establishmentarians or in an interview, Gregory is effusive, super-charged, mobile.

Vocally, he roams the upper registers. To emphasize his point further, he saws at the air, chops away at invisible foliage, fetching an image of Leonard Bernstein breaking Bach down for the masses.

His commanding stage presence enhances his five-foot-nine height. His weight varies according to which stage of his fast you catch him in.

He has lost as much as 40 pounds during these fasts, which he utilizes as hunger strikes against the system. Of late, he has taken to dieting even between fasts.

DICK GREGORY

*a very sick
comic!*

- The Washington Post Times Herald
- The Washington Daily News
- The Evening Star (Washington)
- The Sunday Star (Washington)
- Daily News (New York) 42
- Sunday News (New York)
- New York Post
- The New York Times
- The Sun (Baltimore)
- The Daily World
- The New Leader
- The Wall Street Journal
- The National Observer
- People's World 10
- Examiner (Washington)

REC-105
EX-105

REC-84
5 11 23 10

JUN 22 1970

Date 100-440423-587

DEC 18 1970

70 DEC 21 1970

341

File 5-2

100-440423

b6
b7c

DON'T EAT any meat at all now, I limit myself to vegetables, uncooked vegetables," he says, adding by way of explanation, "You cook vegetables and you burn up all the nutrients in them."

Gregory and his wife, Lillian, have eight children "and none of them eat meat, either."

Home to Dick is an apartment in Chicago for, though he has earned well over a million dollars, he has managed to spend most of it without acquiring the requisites held dear in an acquisitive society.

What happened to the million-plus?

"Why, I don't even have any life insurance," he starts. "You start owning things and your attitude changes. My wife and kids will survive."

There is some indication that much of his earnings has gone to help his "brothers," but he never gets around to the specifics. Still, the inclination is strong to take him at face value about his family never going hungry.

Taking Gregory at his word is what one must

settle for. Keeping up with him is well-nigh impossible, ruling out any chance to catch him in an untruth. In the period between September 27, 1969, and June 4, 1970, he spent \$35,000 on plane fares, fulfilling engagements on scores of campuses.

Catching up with him on the ground is no mean task, either. As part of his health regimen (he has abandoned cigars and whiskey along with the meat and cooked vegetables), he runs up to six miles a day. Or so he says. The skeptical are asked to feel his face, feel how smooth and young the skin is. What can be felt in that sparse patch of skin not adorned with beard does seem smooth, but not having felt it before the "new Gregory" materialized, where can one discern the difference?

STILL, IT MUST be conceded that Gregory is as ready for battle as any 38-year-old can be.

What battle? For Gregory and, presumably, for those who accept his preachments and/or humor as gospel, the struggle is with White America. Make White America synonymous with racist America and you are right on with Dick Gregory.

The Gregory who relishes confrontations in 1970 is more caustic than the Gregory of 1960, whose bag of tricks held more wit than anger. A hardening of the laugh glands, perhaps? Or a reflection of the political murders which have reddened so many pages of our history?

"America always had its nigger. Sometimes he was the Indian, other times the Jew or the Irishman. It started with the Pilgrims. They started at Plymouth Rock and shot and murdered their way clear to California," Gregory says, launching into an in-

dictment which pauses only when breath seems to be running short.

Just at that point when the listener is about to concede that all is lost, it is idle dreaming to think there can be any salvation, Gregory shifts gears just long enough to suggest ways and means of restoring hope.

"The Constitution is America's health chart," he explains patiently. "Americans should get to know it better, because a man without knowledge of himself and what he stands for is like a tree without roots."

"What do I stand for? My bible is 'The Battle Hymn of the Republic', especially where the words say, 'As He died to make men holy, so let us die to make men free . . .'"

The closest he's come to dying is when he was shot while helping to quiet the Watts riots of 1965. Before and after that turbulent time, Gregory spent much time in jail.

It is fatuous, of course, to suggest that Gregory speaks for the blacks of America, either the larger number of moderates or the more militant minority. And Gregory doesn't make that claim.

BUT ON THE other hand, "in every neighborhood, there's some black man who's always ready to say what the white folks want to hear instead of the things they ought to hear."

"So, all I ask is, if you don't go to that black man for a comment on the President's speech in Cambodia or what happened at Kent State, don't let them give you a comment on me and my brothers."

Stoutly defending his right to speak out for the blacks without presuming to be their spokesman, Gregory cites "Martin and Malcolm, Stokely and Rap" as blacks who complemented each other in the cause of civil rights in "a country which puts property rights ahead of human rights."

"And Sammy Davis has been beautiful, the way he helped me take 20,000 turkeys to Mississippi in 1963. Sammy doesn't know how to say 'no.' One little old lady down in Jackson told us she was over 93 and never had turkey in her life and maybe now that she was without any teeth, it was too late, but she thanked us anyway."

"Bill Cosby may be the most significant thing that ever happened for black folks and he doesn't even know it. Now, my kids can see him every week and identify with him. White folks can see him, too, and see a black man who isn't in a jail scene or some Commie rally."

Misgivings have been voiced about Gregory's dedication to civil rights. Gauging the depth of any man's sincerity to any cause is to probe his soul. How much of Gregory's intentions can be gleaned by such surface things as the naming of his twin daughters? He called one Pamela Inte, the other Paula Gration. Get it? Inte-Gration. The girls' mother was pregnant with them when she was locked up during a civil rights protest.

Gregorian chants

There are few things on which Dick Gregory DOESN'T have an opinion. He DOES have an opinion on:

THE PRESIDENCY: When I ran for the office two years ago, I was the only real candidate for President. The others were running for sheriff.

THE FBI: If a nine-year-old can find a dope pusher, why can't the FBI?

NONVIOLENCE: It's a favor and not an obligation, and while I hate to admit it, it has helped the black's cause.

LOOTERS: If you're going to shoot all looters, make it retroactive and give the Indian a gun.

SPIRO AGNEW: He's the kind of cat who'd use the hot line to make a crank call to Moscow.

SPACE FLIGHTS: I heard we've got lots of black astronauts; saving them for the first space flight to the sun.

WIRETAPS: They've got so many bugs on my phone, I'm putting roach powder on it.

WASHINGTON, D.C.: It's the only place where a guy can hold up a bank and get mugged on his way to the getaway car.



DICK DERISIVE



NEWS photos by Dennis Coruso

DICK DEMURE

DICK DENOUNCING

SUPPLEMENTAL CORRELATION SUMMARY
(See Correlation Summaries dated 10/19/64, 11/5/65, 12/5/66,
10/12/67, and 1/22/69, filed as 100-440423-16, 51, 103, 130,
and 428, respectively.)

Main File No.: 100-440423
See Also : 44-22002
56-3912
173-694
173-2601
176-63

Date: 12/14/70

dkw Subject: Richard Claxton⁰ Gregory

Date Searched: 11/28/69

All logical variations of subject's name and aliases were searched and identical references were found as:

SUMMARY

6
~~Gregory, Dick
Gregory, Dick
Gregory, Dick C.
Gregory, Dick Claxton
Gregory, Dicky
Gregory, R. C.~~

5
~~Gregory, R. C. Dick
Gregory, Richard
Gregory, Richard C.
Gregory, Richard Claxton
Gregory, William Richard Claxton~~

This is a summary of information obtained from a review of all "see" references to the subject in Bureau files under the names and aliases listed above. All references under the above names containing data identical with the subject have been included except any indicated at the end of this summary under the heading REFERENCES NOT INCLUDED IN THIS SUMMARY. References indicated in the block as SI contain the same information as the foregoing serial although the information may have been received from a different source.

THIS SUMMARY HAS BEEN PREPARED FOR USE AT THE SEAT OF GOVERNMENT AND IS NOT SUITABLE FOR DISSEMINATION. IT IS DESIGNED TO FURNISH A SYNOPSIS OF THE INFORMATION SET OUT IN EACH REFERENCE, AND IN MANY CASES THE ORIGINAL SERIAL WILL CONTAIN THE INFORMATION IN MORE DETAIL.

dkw
b6
b7c

Analyst

Coordinator

Approved

[Redacted]

[Redacted]

100-440423-3 [Redacted]

CER:mlj *mlj*

WMS REC *dkw*

DEC 15 1970

1-ENCLOSURE

ENCL. BEHIND FILE-SEARCH SLIPS ONLY

MCTB 585

CONSOLIDATION

56 JAN 21 1971

ABBREVIATIONS

Add. info.....Additional information appearing in this reference which pertains to Richard Claxton Gregory can be found in the main file or elsewhere in this summary. This information may have been received from a different source.

DNC.....Democratic National Convention of 1968, Chicago, Ill.

PD.....Police Department

WDC.....Washington, D.C.

"The Sunday Star", published in WDC, on 2/27/66, contained an article entitled "Negroes Plan Armed Unit on Rights". The article stated that a group of militant Negroes had announced plans to form an armed District chapter of the Deacons for Defense and Justice "to defend" against "civil rights abuses". The article continued that Dick Gregory was one of three persons who led the speakers in attacking ghettos, welfare programs and "police brutality", before an audience at radio station WUST Music Hall, 9th and V Sts., N.W., WDC.

157-14001-1 ep. 4
(20)

Former [redacted] advised that on 3/19/68, Dick Gregory spoke at Tulane University, New Orleans, La. Prior to Gregory's talk, he introduced Willie Floyd Ricks [redacted] to those attending by stating "I want you to meet one helicat who makes Stokley and Rap sound like moderates". Following Gregory's speech, Ricks was observed in Gregory's company during the remainder of the evening.

b6
b7C
b7D

[redacted] p. 4,5
(13)

[redacted] advised that on 4/9/68, Ramon Lopez Tijerina [redacted] related that the Alianza Federal of Ciudades Libres group was helping to form a Peace and Freedom Party (PFP) in Albuquerque, N. Mex. Dick Gregory was to run as the Presidential candidate of the PFP, and Reyes Tijerina, brother of Ramon and leader of the Alianza Federal de Mercedes, was to run for Vice-President.

b6
b7C
b7D

[redacted] advised that on 4/9/68, at a meeting of the CP at San Antonio, Texas, there was a discussion of the third party, the PFP, and it was indicated that Ramon had been talked to about that and it was felt that a third party could be formed, having Gregory and Reyes on the ballot.

[redacted] p. 18,19

(18)

[redacted] (Prob.) advised that on 4/9/68, following his appearance at the University of Portland, Portland, Oregon. Dick Gregory made an appearance at the residence of [redacted] where a group had met for a Black Students Union meeting. Gregory stated that he had flown to Portland that day from Atlanta, Ga., where he had attended the funeral of Dr. Martin Luther King. Gregory stated that he was going to stay in this country until it falls, then he was going to leave. He said "I hate this country". His purpose for appearing at various colleges, Gregory said, was to encourage militancy and revolution among the students. He indicated that he was a candidate for President of the US and that following the election he could travel to foreign countries to see if he would be recognized as the President in exile. Gregory in answer to questions as to what students could do to help the cause of destruction in this country, stated that he would say nothing that would cause him to be guilty of conspiracy. However, he did state "keep on doing what you are doing" and noted that in Chicago there was a gasoline station near the freeway where a pipe from a gasoline storage tank could be broken, thereby permitting gasoline to flow on the freeway. Gregory indicated that he was opposed to racial violence, but that violence was the only way for Negroes to gain their manhood.

b6
b7C
b7D

[redacted] (Prob.) gave substantially the same information as above. He advised that Gregory told of his travels throughout the US and eulogized Dr. King. Gregory advocated violence and said that it was not right for the children to do the looting and killing. If it needed to be done, it was the responsibility of adults.

b7D

157-9644-2 p. 20,21
(18)

It. Col [redacted]

b6
b7C

[redacted] furn-
ished information in connection with a letter dated 6/18/68, addressed
to his wife from [redacted] Calif.
The letter included the statement that [redacted]

62-587-720
(9)

[redacted] (protect identity) advised
on 5/8/68, that [redacted] of Dick
Gregory and [redacted] he made a speech at SC on 4/17/68.

b6
b7C
b7D

[redacted] p. 7

(19)

[redacted] on 6/5/68, furnished a Summer of Support (SOS)
(62-112287) pamphlet which in part stated the purpose of SOS and the
establishment of coffee houses near military installations. Among
the entertainers listed as invited by SOS to entertain at the coffee
houses was Dick Gregory (locality not given).

b7D

Pamphlet enclosed

[redacted]
(10)

Sgt. [redacted] Chicago PD, Chicago, Ill., on 6/6/68, advised that [redacted] who along with
two other individuals was wanted in East St. Louis, Ill., for killing
a policeman and was at that time in custody in Chicago, stated that
he and the other two had been given money by the "Black Culture, Inc.",
an East St. Louis black militant group, to flee East St. Louis. [redacted]
also said that if they needed help in Chicago they were to contact Dick
Gregory, Apt. 1030, 1451 East 55th St., Chicago.

b6
b7C

[redacted]
(18)

The "Daily Olympian", a newspaper published in Olympia, Washington, on 6/30/68, carried an article concerning the dismantling of the "Tepee Village" of Janet McCloud* on the grounds of the state capitol in Olympia. According to McCloud, the camp had started out as a protest against the incarceration of Dick Gregory for his part in a well-publicized incident of illegal net fishing by Indians in the Nisqually River.

105-190030-3 ep. 2
(16)

*Northwest Representative of "The Survival of American Indians Association".

[redacted] advised that on 7/5/68, at a special convention of the CP, USA, held at the Diplomat Hotel, NYC, [redacted] (not further identified) in a report commented on the Government's restrictions against the Indians' fishing in certain Indian reservations. In this regard he stated that Dick Gregory was at that time in jail because of his fight to help the Indians in the State of Washington. [redacted] felt the CP should give Gregory their support and fight for his release from jail.

b6
b7C
b7D

100-3-69-11584 ep. 4
(11)

The following references in the file captioned "Congress of Racial Equality (CORE)" set forth information pertaining to the planned 1968 National Convention of CORE, 7/1-7/68, to be held at Columbus, Ohio. Dick Gregory was listed among the speakers and resource people for the convention.

REFERENCE

SEARCH SLIP PAGE NUMBER

100-225892-10-36 ep. 2
-55 p. 2,6

(11)
(11)

[redacted] advised that on 3/23-24/68, at a YMCA Camp near Chicago, a conference was held for the purpose of establishing plans for the disruption of the DNC in Chicago in August, 1968. At the conference the Negro representatives decided to hold separate meetings. The source was of the opinion that this so called Black Caucus would follow the lead of Dick Gregory and support any action which he suggested.

b7D

176-763-2 ep. 2
(22)
SI176-794-2 ep. 2
(22)

On 8/2/68, Dick Gregory, who was seeking the Peace and Freedom Party (100-447961) nomination for the Presidency, was to speak at the Glide Memorial Church, Taylor and Ellis Street, San Francisco, Calif. (Source not given).

100-447961-49 ep. 1
(13)

[redacted] (protect identity) advised that on 8/3/68, Eldridge Cleaver, Black Panther Party leader, won the State Peace and Freedom Party (100-447961) delegation in balloting for the Presidential nominee. His nearest rival was civil rights leader Dick Gregory. Both Cleaver and Gregory spoke before the conventions in Los Angeles and San Francisco, Calif.

b7D

100-447961-46 ep. 1
(13)

Richard Claxton Gregory, Chicago, was listed among independent Black Nationalist extremists and was reported as still active at that time. (Chicago Report 8/9/68.)

157-8415-9-20 p. 1,8
(6)

Detective [redacted] (protect identity), furnished a brochure regarding the Southern Christian Leadership Conference (SCLC) (100-438794) Convention held in Memphis, Tenn., 8/14-17/68. Listed on the agenda of activities for 8/15/68, was the presentation of a Special Award to Dick Gregory by Dr. Ralph David Abernathy, SCLC president.

b6
b7C
b7D

Brochure enclosed
100-438794-2327 ep. 6,39
(12)

[redacted] (Prob) advised that Eldridge Cleaver* was reportedly disenchanted with the Peace and Freedom Party (100-447961) convention which was held at Ann Arbor, Mich., 8/17-18/68, and was considering declining the Presidential nomination in favor of Dick Gregory..

b7D

Add. info.

100-447961-56 p. 20-22
(13)

*Minister of Information, Black Panther Party

[redacted] advised that on either 8/26 or 27/68, during the DNC he had spent the day in Lincoln Park, Chicago, selling literature, posters and buttons, in support of Citizens for Independent Political Action (CIPA), 1903 Hayward St., Chicago. This activity was carried on in conjunction with representatives of the Peace and Freedom Party which organization was rather loosely organized and desired to support Dick Gregory as a local Chicago candidate and Eldridge Cleaver as a national level candidate. Seibel indicated that it was the view of most CIPA representatives that it would be better to support the national candidacy of Cleaver rather than to support the local candidacy of Gregory because the latter was regarded as a comedian which did nothing for him as a candidate for public office.

b6
b7c

[redacted] p. 1,4

(14)

[redacted] advised that on 8/29/68, during a demonstration in front of the Conrad Hilton Hotel on Michigan Ave., in Chicago, Dick Gregory introduced an individual who, he claimed, was a deserter from the US Army.

b6
b7c

A review of Chicago PD information concerning speeches in the vicinity of the Conrad Hilton Hotel on 8/29/68, including a speech by Gregory, failed to develop any information concerning the above incident.

176-78-1 p. 2

(21)

[redacted] Cleveland, Ohio, advised in an interview on 9/18/68, that Richard (Dick) Gregory was known to him only as a Negro entertainer.

176-51-29 p. 3

(2)

The following references set forth information regarding the activities of Richard Claxton Gregory during the period 12/8/67 through 9/20/68, in connection with the demonstrations which transpired in Chicago during the DNC. Gregory, an entertainer and civil rights activist who had been arrested numerous times in connection with his civil rights activities, prior to the DNC made a nationwide tour speaking at various colleges. At the colleges he called for persons

(continued)

(continued)

to go to Chicago during the DNC for the purpose of participating in demonstrations. A number of times Gregory announced plans to disrupt the DNC. He said the convention would be held only over his dead body unless his terms were met. However, in April of 1968, Gregory announced cancellation of his plans to protest the DNC. Nevertheless, Gregory did appear in Chicago during the DNC and spoke at the "LBJ un-Birthday Party" and to the demonstrators, participated in rallies and led a march of demonstrators in the direction of the Amphitheatre where the DNC was being held. The march was halted by the authorities and the marchers returned to Grant Park where the march had originated. Gregory again led a large group out of the park, supposedly toward his home. Once again they were stopped by the police and upon Gregory's urging, the marchers continued to move forward thereupon forcing the police to arrest a large number including Gregory. Background data set forth.

REFERENCE

SEARCH SLIP PAGE NUMBER

44-40353-162 p. 13,746,761,783, 898,903,1011,1012, 1062,1145,1148, 1234, 1235,1283,1294. (arrested)	(9)
-242 p. 26,27 (arrested)	(9)
-243 p. 30,85,93,138,226, 275,346	(9)
-321 p. 4	(9)
100-0-39339 ep. 1-4	(11)
100-438281-175 p. 206,249	(2;12)
100-449698-10-8	(14)
100-449698-47-28 p. 4, ep. 15-17,23	(14)
100-449923-41p. 26	(14)
157-1760-16 p. 3	(17)
157-8249-5 ep. 5	(17)
157-8589-249 ep. 18,21,22 (arrested)	(17)
-739 ep. 1	(17)

(continued)

(continued)

REFERENCE

SEARCH SLIP PAGE NUMBER

157-8589-1222 p. 2	(17)
-1480	(17)
-1552 ep. 11 (arrested)	(18)
-1688 ep. 8	(18)
-1691 ep. 6	(18)
-1696 ep. 9	(18)
-1719 ep. 10,11 (arrested)	(18)
-1730 ep. 3,5,7,10	(18)
176-32-6 ep. 3	(20)
176-34-23 p. 4,6,17	(6;21)
-56 p. 10	(6)
176-39-15 p. 13,19,20,57,58,	(6;21)
61	
-19 p. 16,17,29,33,37,	(21)
45,46,49,58,59	
176-51-99 p. 9,22-24	(2;21)
176-60-13 ep. 1	(21)
176-62-37 p. 26,28,39	(2;6)
176-72-1 p. 13	(21)
176-73-49 p. 7	(21)
176-115-1 p. 5	(21)
176-138-4	(21)
176-245-1 p. 5,6	(21)
176-333-6 p. 2,3 (arrested).	(22)
176-653-2 p. 5	(22)
176-706-3 p. 5,6	(22)
176-863-12 p. 3	(3)

(continued)

(continued)

REFERENCE

SEARCH SLIP PAGE NUMBER

176-1410-26 p. 5,20 (Photo)
-82 p. 1
-112
-303 p. 1,9
-401 p. 14,15

(4;8)
(6)
(6;22)
(22)
(6)

[redacted] made three telephone calls* to the Chicago area. (source not given).

b6
b7C

According to the Illinois Bell Telephone Company, Chicago, one of those calls was made to a number assigned to [redacted] and Richard Gregory, 1451 East 55th St., Chicago.

[redacted]
(1;5;9)

*According to serial 59 the above calls were made during the period 3/16/68 to 9/22/68.

[redacted] furnished a flyer bearing the heading "Flames of Liberation" which was distributed on the campus of Marquette University (MU), Milwaukee, Wisc. Among other items the flyer stated that Dick Gregory was scheduled to speak at MU on 9/25/68. The reverse side of the flyer contained the statement "Liberation Timetable" which set out a number of dates including the above date indicating that Gregory would speak on Revolution in America.

b6
b7C
b7D

[redacted] advised that on 9/25/68, Gregory spoke in the Brooks Memorial Union of MU. At the completion of his speech Gregory headed a group of demonstrators and marched to Milwaukee P.D. Headquarters where 14 persons arrested for entering Selective Service Headquarters, Milwaukee, and destroying its records, were incarcerated.

[redacted] Detective, [redacted] on 9/26/68, advised that when the above demonstrators arrived at Milwaukee PD Headquarters, Gregory was arrested for failure to pay a traffic citation which was almost one year old. He was later released.

105-138315-30-30 ep. 2-4
(15)

[redacted] advised that at a meeting of the Students for Peace, a campus approved student organization at the University of Pittsburgh (UP), Pittsburgh, Pa., activities planned by the Resistance (14-2965) of Pittsburgh during September and October, 1968, were announced. Included was a planned visit to the UP by Dick Gregory and a large demonstration of support was being planned.

b7D

14-2965-39-9 ep. 2
(8)

The "Minneapolis Tribune", a newspaper published in Minneapolis, Minn., on 10/30/68, published a report on the remarks of Harry Edwards [redacted] in a speech at St. Cloud State College, St. Cloud, Minn. In regards to the Presidential election, Edwards forecast that Dick Gregory could draw 25 million votes on November 5th if he were in the running for President.

b6
b7C

[redacted]
(17)

[redacted] advised that on 11/3/68, [redacted] a member of the Secretariat, CP, USA, advised that Charlene Alexander Mitchell, CP, USA, candidate for the Presidency of the US, had been telling people not to vote for her and to cast their vote instead for Dick Gregory (locality not given).

100-3-114-1244 ep. 1
(11)

[redacted] advised that on 11/4/68, Charlene Alexander Mitchell, Field Secretary of the CP, USA, Commission on Black Liberation, and the CP, USA candidate for President of the US, spoke at Howard University, WDC. Mitchell's comments dealt with the platform advocated by the CP, USA. She requested those present to get out and vote for the various Black candidates such as Dick Gregory, well known Negro militant who advocated programs similar to certain segments of the CP platform.

b6
b7C
b7D

100-442529-2754 p. 3
(13)

[redacted] advised that the United Black Students (UBS), University of Miami (UM), Coral Gables, Fla. (157-9543), tried to give

(continued)

(continued)

the impression that they sponsored the appearance of Dick Gregory at the UM on 11/6/68, but actually the UM had arranged for his appearance in the spring of 1968, prior to the formation of UBS, UM. Following his speech at the UM, Gregory met with a black only group for approximately one hour.

Add. info.

157-9543-25 p. 5
(6;18)

The following references in the file captioned "Peace and Freedom Party (PFP)" set forth information regarding the activities of Richard Claxton Gregory during the period 7/16/68 through 11/8/68, in Michigan, Kentucky, Virginia and New York. Gregory, an entertainer and civil rights activist, was a nominee for the Presidential candidacy on the PFP ticket. At the PFP founding convention, Gregory stated that "This corrupt and insane nation should be straightened out or destroyed so the rest of the world can breathe fresh air". He also stated that "There are a lot of people I'd like to shoot", but added that he would not because he was a coward. The CP, USA, officially supported Gregory's nomination for President of the US. Eldridge Cleaver won the nomination over Gregory.

REFERENCE

SEARCH SLIP PAGE NUMBER

62-112423-23	(10)
-29 ep. 3,8,12,16,17, 33,45	(5;10)
-30 ep. 2	(10)
-35 ep. 1	(10)
-54	(10)
-66 p. A,1-3,9-11	(5;10)
-99X p. 2	(14)
-107 p. 1,5,29,53,70, 76-78,125,126,128, 135-149,168,191,194, 235,255,257-259,262	(5;10)

Appearances in Grand Rapids, Mich., recent to January, 1969, by Dick Gregory were sponsored by "The Organizer", a newspaper in Grand Rapids, which appeared to be connected with individuals operating the "New Concept Book Store", 36 Hall S.E., Grand Rapids. (Source not given).

157-11215-2
(19)

121

[redacted] reported on 11/15/68, that Arthur I. Waskow of the Institute for Policy Studies, WDC, in his proposals for "Counter-Inaugural" plans in connection with the inauguration of the President in WDC on 1/20/69, endorsed a proposal by Dick Gregory. Gregory had proposed a Counter-Inaugural parade and the opening of a Black House on behalf of a President of the People in Exile. Waskow also suggested the inauguration of a "panel of people", which included Gregory, who would use the "Black House" as a WDC base.

b7D

Document enclosed.
62-111181-2380 ep. 2,9
(9)

The following references in the file captioned "Demonstrations During Presidential Inauguration Ceremonies, WDC, 1/19-20/69" set forth information regarding the activities of Dick Gregory during the period 11/1/68 through 1/20/69, in connection with the above demonstrations. Gregory was invited to speak at a "conference on the movement", sponsored by the National Mobilization Committee to End the War in Vietnam (NMC), which was to be held at Federal City College, WDC, during the Inaugural period. At a NMC meeting, Gregory was suggested as master-of-ceremonies at a planned counter-inauguration ball to coincide with the Presidential Inaugural Ball. A house, to be called "The Black House" was purchased in WDC which was to be used by Gregory and another person in running an "American Government in exile".

REFERENCE

SEARCH SLIP PAGE NUMBER

100-451694-42 ep. 5
-182 ep. 1
-188 ep. 2
-324 p. 3

(14)
(14)
(14)
(14)

[redacted] (protect identity), advised that [redacted] had succeeded in gaining WIU approval for speeches by Dick Gregory and others at a black conference on racial issues to be held on 1/23-26/69, at WIU.

b6
b7C
b7D

[redacted]
(20)

[redacted] (PROB) advised that on 2/8-9/69, a Convention of the New Politics Party of Indiana, which was composed of, primarily, individuals who supported Dick Gregory for President of the US in the 1968 November elections, was held at North Webster, Indiana.

b7D

157-12824-1 ep. 3
(20)

[redacted] (protect identity) [redacted] advised that according to [redacted]

157-8415-243-55 ep. 1
(17)

The following references set forth information regarding student agitation and a sit-in at American University, WDC, during the period 2/25/69 through 3/2/69, in connection with an issue involving the rejection by the school administration of a request to hold an inaugural ball for Dick Gregory who was scheduled to be inaugurated as the "President-in'Exile" of the US on 3/4/69.

REFERENCE

SEARCH SLIP PAGE NUMBER

62-112228-53-53 ep. 1,3-5,7,11,
13

(10)

100-439048-53-157 p. 61

(12)

The "Washington Post", a WDC newspaper, on 1/25/69, contained an article which related that the Executive Committee of the New Party (NP) in a press conference at the Sheraton-Carlton Hotel, WDC, on 1/24/69, announced that the NP had elected Dick Gregory as a co-chairman of the party. The NP, which was building an "exiled government" in WDC, announced plans for the 3/4/69, "inauguration" of Gregory as "shadow" president of the US.

On 3/4/69, an FBI representative obtained a leaflet entitled "New Party Town Meeting", AME Church, 1518 M. St., N. W., WDC. The agenda included the topic "Hunger and Malnutrition in the United States", Dick Gregory (New Party President in Exile).

100-447935-6 p. 48,49
(13)

The "Knoxville News-Sentinel", a newspaper published in Knoxville, Tenn., on 3/24/69, contained an article which stated that Julian Bond (157-10820), who had canceled a speaking engagement at the University of Tennessee, Knoxville, the previous fall because of the school's refusal to allow Dick Gregory to speak, was scheduled to speak at the civic auditorium.

157-10820-5 ep. 1
(19)

In 1968, Dick Gregory, self-proclaimed "President-in-Exile", campaigned for the US Presidency as a write-in candidate, and was also on the ballot in several states as a candidate of the Peace and Freedom Party and the New Party (NP). The NP was described as building an "Exile Government" in WDC to "further the politics of participation".

On 4/1/69, during a meeting of the United Black Brotherhood (157-12777) in WDC, mention was made of a "Zerox" machine belonging to the NP which was being moved from the NP address in WDC, to the "Black House" of Dick Gregory elsewhere in the city.

[redacted] (Prob.)
157-12777-25 ep. 3,4
(19)
SI 157-12777-36 p. 19
(19)

[redacted] Illinois State University (ISU), Normal, Ill. (protect identity), advised that it was the hope of the Black Student Association, a militant black student organization on the ISU campus, that Dick Gregory would appear on 4/11/69 and officially open the Association of Women Students (AWS) Symposium (157-12944), at ISU. However, due to his incarceration in the Cook County Jail, Chicago, Gregory could not appear as scheduled, therefore the scheduled kickoff for the AWS Symposium on 4/11/69 was cancelled.

b6
b7C
b7D

157-12944-10 ep. 1
(20)

[redacted] and [redacted] advised that a demonstration reportedly sponsored by the Chicago Peace Council, was to be held at the Cook County Jail, Chicago, on 4/13/69, to protest the incarceration there of Dick Gregory. Gregory was incarcerated on a charge growing out of a 1965 sit-in demonstration.

b7D

(continued)

(continued)

On 4/13/69, SAs observed the above demonstration in front of the cell window where Gregory was confined. Gregory spoke from his cell window and gave "peace" and "black power" hand signs to the demonstrators.

100-444394-59 ep. 1
(13)

The following references in the file captioned "New Party (NP)" set forth information regarding Dick Gregory in WDC during the period November, 1968 through 5/3/69. Gregory was elected as a co-chairman of the NP and was to be inaugurated as "shadow" President of the US. During the November, 1968, elections groups in several states allegedly attempted to place Gregory's name in contention by a write-in campaign. One of the demands of student demonstrators at American University (AU), WDC, was that Gregory's inauguration gala take place at AU.

REFERENCE

SEARCH SLIP PAGE NUMBER

100-452574-1 ep. 1,2
-21 p. 6
-31 ep. 1
-38
-47 p. 9, 18

(14)
(15)
(15)
(5,15)
(15)

[redacted] (protect identity), advised that an announcement over a local radio station stated that Dick Gregory would appear at a "rap session" which would be held at the Page Park YMCA on 6/7,8/69.

b6
b7C
b7D

[redacted] PROB and [redacted] PROB advised that the above announced "rap session" failed to materialize.

157-14209-1 ep. 1
(20)

[redacted] (protect identity), advised that approximately two years before, Semu Huaute, who claimed to be a Chumash Indian from Southern California, was scheduled to go to Hanoi, North Vietnam with Dick Gregory for the alleged purpose of entertaining American prisoners at Christmas. The trip was subsequently aborted for unknown reasons. (Letterhead memorandum, 6/21/69.)

98-46341-6 ep. 3
(11)

The following references in the file captioned "World Peace Council (WPC), Berlin, East Germany, 6/21-24/69" set forth information regarding the activities of Richard (Dick) Gregory in connection with the above meeting during the period 6/20-24/69. Gregory, described as an entertainer, author and lecturer from Chicago, and his wife were members of the American delegation to the WPC. At the meeting Gregory was chairman of a Subcommittee on Racism. He was reportedly bored by the proceedings and rarely showed up. During one of his rare appearances he reportedly roused Soviet ire by stating that the Soviet anti-Chinese stance was nothing but racism. Gregory also was reported to have remarked that the Soviet delegates were running the show at the WPC.

REFERENCE

SEARCH SLIP PAGE NUMBER

100-361031-1097	(11)
-1107 ep. 2	(12)
-1107X ep. 1	(12)
-1119 ep. 29	(12)
-1120 ep. 1	(1,12)
-1121 p. 2	(12)
-1123 ep. 78	(2,12)
-1124	(12)

US Army Operations and Research Detachment, Frankfurt/Main, Federal Republic of Germany, furnished a copy of a letter postmarked 5/29/69 from [redacted]

b6
b7c

[redacted] The letter requested that personal invitations to attend the Assembly, 6/21-24/69, be sent to a number of important individuals including Dick Gregory, Chicago.

100-332485-51 ep. 9
(11)

[redacted] advised that on 7/14/69, a delegation of three persons including possibly Dick Gregory, were to leave Chicago enroute to Hanoi. They were to go to New York and from there to Paris, then on to Cambodia, arriving in Hanoi, North Vietnam on 7/18/69. In North Vietnam they were to talk to GI's, North Vietnamese Government and youth organizations.

b7D

100-439048-2912
(12)

[redacted] (protect identity), advised that on 6/27/69, Paul Krassner, Editor of "The Realist", a magazine, in a speech at the Washington Square Church, 135 West 4th St., NYC, stated that Dick Gregory was possibly a part of the Movement Speakers Bureau (MSB) (100-454802).

b6
b7C
b7D

[redacted] (Prob) on 8/14/69, made available an undated letter from the MSB, which listed Gregory as a member of the MSB Advisory Board.

100-454802-3 p. 6,10
(15)

[redacted] stated that she had talked to Dick Gregory [redacted] Gregory suggested that [redacted]

b6
b7C
b7D

He suggested that if he was able, he would come to WDC for a benefit performance for the [redacted] Gregory reminded [redacted] that he had been refusing to pay income tax and as a result the Internal Revenue Service had been seizing his share of any performances he gave. [redacted] offered to help supplement Gregory's benefit by getting in touch with local entertainers. (Source not given).

The above was set out in LHM, 8/28/69.

105-138315-53-93 ep. 4
(15)

[redacted] advised that on 9/8/69, at a meeting of the Washington Mobilization Committee to End the War in Vietnam held at Pierce Hall, 16th and Harvard Sts., N.W., WDC, it was reported that no progress had been made in arranging a fund raising benefit featuring Dick Gregory.

b7D

62-111181-2453
(9)

The "Quicksilver Times" (100-454525), WDC, issue for 8/29-9/9/69, listed Dick Gregory as a contributor.

100-454525-3 ep. 3
(15)

James Bowling, Fayette County Sheriff, Somerville, Tenn., advised that on 9/28/69, Dick Gregory participated in a march and rally by Negro demonstrators in Somerville, Tenn.

173-6726-5

(20)

SI 173-6726-7 ep. 1

(20)

The following references contain information pertaining to meetings and affairs that Richard Claxton Gregory participated in during the period 6/22/67 through 10/15/69. Gregory was a speaker or scheduled to speak at many of these functions and his speeches generally concerned civil rights or the war in Vietnam.

DATE	LOCALITY	SPONSOR OR TYPE OF AFFAIR	REFERENCE	SEARCH SLIP PAGE NUMBER
6/22/67	WDC.	Washington Mobilization Committee to End the War in Vietnam	100-453323-3 *p. 17	(15)
4/5-7/68	University of Texas, El Paso	Afro-American Students Association (Black Students Conference)	157-14294-15	(20)
4/13/68	WDC	Center for Emergency Support, aka Committee for Emergency Support	100-41949-167 p. 5	(11)
8/20/68	Kansas State University, Manhattan, Kans.	National Student Association Congress (Scheduled speaker)	157-8589-542 p. 3	(17)
8/22/68	Barat College, Lake Forest, Ill.	National Welfare Rights Organization Convention	157-8813-4 ep. 2,3	(18)

(continued)

(continued)

DATE	LOCALITY	SPONSOR OR TYPE OF AFFAIR	REFERENCE	SEARCH SLIP PAGE NUMBER
9/26/68	Maryland, Illinois	Baltimore Defense Committee (Demon- strations in con- nection with Cat- onsville Nine Trial	100-451045-46 ep. 1,2	(14)
10/11-14/68	McGill Uni- versity, Mon- treal, Canada	First Congress of Black Writers	100-446080-2222 p. 169	(13)
10/14/68	McGill Univer- sity, Montreal, Canada	Congress of Black Writers (Announced that Gregory might attend)	157-10743-40 ep. 2	(19)
10/14/68	McGill Univer- sity, Montreal, Canada	Congress of Black Writers (listed as a speaker on Con- gress program)	157-10743-47 ep. 24	(19)
10/22/68	University of Wisconsin, Madison	(Not given)	100-449613-17 p. 6	(13)
10-21-23/68	University of Wisconsin, Madison	"Vietnam Week"	62-112525-81 ep. (10) 4-6	
1/15/69	Colorado College, Colorado Springs	Colorado College- Symposium on the Subject of vio- lence. (To be a guest lecturer)	100-448162-27 ep. (13) 1	
1/17,18/69	Grand Rapids, Mich. Fountain St. Church	Blacks United for Freedom	100-449626-4 ep. 2	(14)

(continued)

(continued)

DATE	LOCALITY	SPONSOR OR TYPE OF AFFAIR	REFERENCE	SEARCH SLIP PAGE NUMBER
1/17,18/69	Fountain Street Church, Grand Rapids, Mich.	Blacks United for Freedom	157-9412-3 ep.2	(18)
			157-11988-3 ep. 1,4,5	(19)
2/7/69	Augustana College, Rock Island, Ill.	Augustana Representative Assembly Student Government Body and Afro-American Society, Augustana College. (Black Power Symposium)	157-12348-1 ep. 1,2	(19)
			-3 ep. 1,2	(19)
2/14/69	Acadia University, Wolfville, Nova Scotia, Canada	"Soul Day" (a Black Conference) (expected to attend)	157-12448-1 ep. 1	(6,19)
2/24/69	St. Petersburg, Fla.	Bayfront Center, St. Petersburg	157-11587-3 p. 2	(6)
4/11/69	Illinois State University, Normal, Ill.	Black Students Association-Association of Women Students Symposium (Scheduled to appear)	157-12944-1 ep. 2	(20)
5/19/69	Capitol Theater, Chicago	Malcolm X Black Hand Society of the World, Inc.	157-9393-9 ep. 2,3	(18)
8/17/69	San Clemente, Calif.	Los Angeles Peace Action Council (Demonstration against President) (to be invited to appear and speak)	100-454848-57 ep. 2	(15)

(continued)

(continued)

DATE	LOCALITY	SPONSOR OR TYPE OF AFFAIR	REFERENCE	SEARCH SLIP PAGE NUMBER
10/14/69	Mankato State College, Man- kato, Minn.	Vietnam Morator- ium Day activities. Spoke on campus	100-454565-376 p. 4	(15)
10/15/69	University of Connecticut, Storrs, Conn.	Vietnam Morator- ium Day activities. spoke on campus	ep. 8	-490 (15)

The following references in the file captioned "Racial Matters" set forth information regarding the activities of Richard Claxton Gregory during the period 8/29/68 through 10/20/69, in Alabama, Florida, Georgia, Illinois, Michigan, New York, New Jersey, Tennessee, Virginia and WDC. Gregory, a professional entertainer and civil rights activist, actively supported most civil rights groups. He spoke at numerous universities, gave benefits, led marches, participated in voter registration drives, demonstrations and sit-ins in connection with civil rights activities. He was arrested in several cities across the US for those activities including in Chicago during the DNC in 1968. He served a jail term on a charge of battery and resisting arrest. Gregory spoke in a number of colleges and universities. He authored three books concerning civil rights. In 1968, Gregory was a Presidential candidate on the Peace and Freedom Party ticket.

REFERENCE	SEARCH SLIP PAGE NUMBER
157-6-2151 p. 1,3	(16)
157-6-4-3101 ep. 1	(2,16)
157-6-6-801 p. 1, ep. 2-5 -803 ep. 3,4,6	(16) (2,16)
157-6-9-7824 p. 1,2 -8005 ep. 16,17 (arrested)	(16) (6)
157-6-15-2870 p. 1, ep. 1-3	(16)

(continued)

(continued)

REFERENCE	SEARCH SLIP PAGE NUMBER
157-6-21-1123	(16)
157-6-24-748 ep. 39	(16)
157-6-31-2361 ep. 112	(16)
157-6-49-2915 ep. 6a, 15	(17)
157-6-52-1788 ep. 12,13	(17)
157-6-56-618 ep. 4,5	(3)
157-6-64-2057 ep. 15	(17)

[redacted] on 11/5/69, advised that men like Dick Gregory were scouts for military groups in the US and Mexico whose purpose was to kill the President of the US. He described "the Mexico group" as being styled like North Vietnam regular forces around the DMZ.

157-6-23-828
(16)

b6
b7C
b7D

[redacted] (protect identity) advised that Dick Gregory was scheduled to appear at Jacksonville University, Jacksonville, Fla., on 11/12/69, however, no plans had been made for any sort of demonstration in connection with Gregory's appearance.

62-112228-63-63 p. 2
(10)

REFERENCES NOT INCLUDED IN THIS SUMMARY

The following reference on Dick Gregory located in files maintained in the Special File Room of the Records Branch, Files and Communications Division IV, was not reviewed, and it is not known whether it is identical with the subject of this summary.

REFERENCE

SEARCH SLIP PAGE NUMBER

64-330-339

(11)

See the search slip filed behind file for other references on this subject which contain the same information (SI) that is set out in the main file. Although the information is the same it may have been received from different sources.

F B I

Date: 12/21/70

~~CONFIDENTIAL~~

Transmit the following in _____
(Type in plaintext or code)

Via A I R TEL _____
(Priority)

TO : DIRECTOR, FBI (100-440423)
FROM : SAC, CHICAGO (157-347) (P)
SUBJECT: RICHARD CLAXTON GREGORY, aka
RM - BN
(OO: CHICAGO)

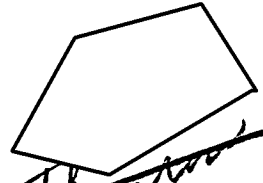

100563

Attorney

Remylet and LHM dated 11/25/70, and captioned as above.

Enclosed for the Bureau are 11 copies of an LHM, dated and captioned as above. No local dissemination being made, so as to preclude the possibility of pinpointing this source.

Source is [redacted] and he has been targeted to develop information regarding GREGORY's Mexican travel. ~~(S)~~ (U)

This LHM is being classified confidential to further protect the identity of this source, who is of continuing value.

AGENCY: ICDSO, ~~INT. SEC.~~ SEC. SERV., IRS & CIA, STATE
Dir: ~~LEGAT - London, Madrid, Mex, city~~
HOW FORW: RS
DATE FORW: 12-30-70
BY: CEE/PP/FOCP LT8040

APPROPRIATE AGENCIES AND FIELD OFFICES ADVISED BY ROUTING SLIP ON 2-3-80

2 - Bureau (Encl. 11) (RM)
2 - Chicago
(1 - A) [redacted]

REC-6 100-440423-589
EX-113

6 DEC 23 1970

HHS:aja
(4)

1-17-80
CLASS. & EXT. BY 2842 pjs/ci
REASON-FCIM II, 1-2.4.2 2
DATE OF REVIEW 12-31-90

RASH/CEE

66 JAN 6 1971 *CWB*
Special Agent in Charge

Sent _____ M Per _____

b6
b7C

b6
b7C
b7D



UNITED STATES DEPARTMENT OF JUSTICE

FEDERAL BUREAU OF INVESTIGATION

In Reply, Please Refer to
File No. 157-347

Chicago, Illinois
December 21, 1970

~~CONFIDENTIAL~~

~~CONFIDENTIAL~~

RICHARD CLAXTON GREGORY
ALSO KNOWN AS
DICK GREGORY

On [redacted] a confidential source, who
has furnished reliable information in the past, advised

[redacted]

~~(S)~~ (U)

b7D

On [redacted] the source advised that he

[redacted]

~~(S)~~ (U)

Gregory advised that

[redacted]

~~(S)~~ (U)

Gregory, who is an American citizen and self
appointed political activist and human rights advocate, had

[redacted]

~~(S)~~ (U)

APPROPRIATE AGENCIES AND FIELD OFFICES
ADVISED BY ROUTING SLIP ON 2-8-82

1-17-80
CLASS. & EXT. BY 3842 PVD/c
REASON-FCIM II, 1-2.4.2 2
DATE OF REVIEW 12-21-90

~~CONFIDENTIAL~~
Classification
Group 1
Excluded from automatic
downgrading and
declassification

~~CONFIDENTIAL~~
1*

~~CONFIDENTIAL~~

This document contains neither recommendations nor conclusions
of the FBI. It is the property of the FBI and is loaned to your
agency; it and its contents are not to be distributed outside
your agency.

100-440423-589

ENCLOSURE

UNITED STATES GOVERNMENT

Memorandum

TO : DIRECTOR, FBI (157-12382)

DATE: 1/5/71

FROM : SAC, TAMPA (157-3163) (RUC)

SUBJECT: RICHARD CLAXTON GREGORY
RM
(OO:CG)

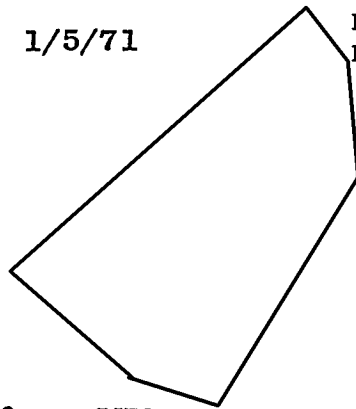

b6
b7C

ReTPteletype to Director, 10/6/70.

Enclosed for the Bureau are 8 copies of an LHM and 2 copies of an FD-376.

Enclosed for Chicago are 2 copies of LHM bearing above caption.

Copies of enclosed LHM are being disseminated locally to Secret Service, Jacksonville; MI, Orlando, USA, Orlando and OSI, Patrick AFB, Fla.

Source utilized in enclosed LHM is (U)

SA Florida Department of Law Enforcement, Orlando, Fla., made a tape recording of subject's speech at Rollins College using a Kelcon SK-7 Recorder; however, poor acoustics in the field house made this recording unintelligible.

b6
b7C
b7D

1-17-80
CLASS. & EXT. BY 2842 pvd/ci
REASON-FCIM II, 1-2.4.2
DATE OF REVIEW 1-5-91

ENCLOSURE

- ② - Bureau (157-12382) (Encl 10) (RM)
 - 2 - Chicago (157-347) (Encl 2) (RM)
 - 2 - Tampa
 - 1 - 80-139
- GDW:fw
(6)

100-440423-590
~~157-12382-590~~

REC-69

EX 105

JAN 8 1971

AGENCY: ~~ISD, NIC, OSI, SEC, SERV, TRF~~
DEPT: ~~ISD, CRD, INT, OD~~

HOW FORW: AS
DATE FORW: 1-12-71
BY: CO-972 4800 178092

61 JAN 1971

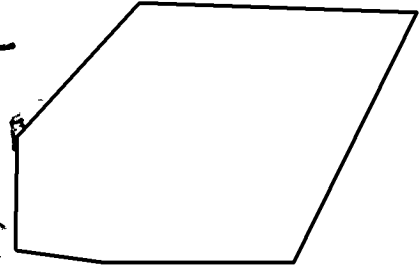

APPROPRIATE AGENCIES AND FIELD OFFICES ADVISED BY ROUTING SLIP ON 2-8-80 gub



FEB 4 1971



8

8

UNITED STATES DEPARTMENT OF JUSTICE
FEDERAL BUREAU OF INVESTIGATION

In Reply, Please Refer to
File No.

WASHINGTON, D.C. 20535
January 5, 1971

Director
United States Secret Service
Department of the Treasury
Washington, D. C. 20220

Dear Sir:

The information furnished herewith concerns an individual who is believed to be covered by the agreement between the FBI and Secret Service concerning Presidential-protection, and to fall within the category or categories checked.

1. Has attempted or threatened bodily harm to any government official or employee, including foreign government officials residing in or planning an imminent visit to the U. S., because of his official status.
2. Has attempted or threatened to redress a grievance against any public official by other than legal means.
3. Because of background is potentially dangerous; or has been identified as member or participant in communist movement; or has been under active investigation as member of other group or organization inimical to U. S.
4. U. S. citizens or residents who defect from the U. S. to countries in the Soviet or Chinese Communist blocs, and return.
5. Subversives, ultrarightists, racists and fascists who meet one or more of the following criteria:
 - (a) Evidence of emotional instability (including unstable residence and employment record) or irrational or suicidal behavior;
 - (b) Expressions of strong or violent anti-U. S. sentiment;
 - (c) Prior acts (including arrests or convictions) or conduct or statements indicating a propensity for violence and antipathy toward good order and government.
6. Individuals involved in illegal bombing or illegal bomb-making.

Photograph has been furnished enclosed is not available
 may be available through _____

Very truly yours,

J. Edgar Hoover
John Edgar Hoover
Director

1 - Special Agent in Charge (Enclosure(s))
U. S. Secret Service, Jacksonville (RM)

Enclosure(s)

(Upon removal of classified enclosures, if any, this transmittal form
becomes UNCLASSIFIED.)



UNITED STATES DEPARTMENT OF JUSTICE
FEDERAL BUREAU OF INVESTIGATION

In Reply, Please Refer to
File No.

Tampa, Florida
JAN 5 1971

RICHARD CLAXTON GREGORY

Detective [redacted] Winter Park, Florida, advised on October 6, 1970, that he had determined that Dick Gregory was scheduled to make a speech at the Rollins College Field House, Winter Park, Florida, at 8 P. M. on October 7, 1970. Detective [redacted] stated that Gregory's appearance was sponsored by the Student Educational Entertainment Committee at Rollins College and the topic of his speech would be "Social Problems: Social or Anti-Social?".

b6
b7c

Detective [redacted] furnished a copy of the October 2, 1970, edition of "The Rollins Sandspur", the Rollins College student newspaper. This publication, in an article entitled "Dick Gregory Tries Again", disclosed that two years ago the Student Educational Entertainment Committee, with the agreement of the Board of Directors at Rollins College, signed a contract with Gregory to appear at Rollins College on March 19, 1968; however, this contract subsequently had been canceled either by the college administration or by student leaders. This article continued that Gregory was scheduled to speak at Rollins College on October 7, 1970, for approximately one hour on the topic "Social Problems: Social or Anti-Social?".

A confidential source, who has furnished reliable information in the past, advised on October 16, 1970, that

~~CLASS. & EXT. BY~~
~~REASON-CIM II, 1-2.4.2~~
~~DATE OF REVIEW~~

ALL INFORMATION CONTAINED
HEREIN IS UNCLASSIFIED
DATE 1-17-80 BY 2842/cv

100-440423-590

ENCLOSURE 157-12382-590

RICHARD CLAXTON GREGORY

Dick Gregory spoke for approximately one hour and fifteen minutes at the Rollins College Field House, Winter Park, on the evening of October 7, 1970. Gregory, in his speech, criticized the intellect of United States Government officials and used numerous illustrations to make the point that a modern revolution in this country is inevitable. This source said that Gregory in his speech did not advocate violence in this country.

The October 11, 1970, edition of the "Orlando Sentinel", an Orlando, Florida, daily newspaper, in an article entitled "Gregory At Rollins", stated that Dick Gregory, on the night of October 7, 1970, spoke to a crowd of 700 people at Rollins College, Winter Park. According to this article, Gregory directed his speech at the students present stating "the fate and destiny of America depends on young folks". He commented that America was going through a period of "repression", adding that views of minority groups were being repressed or ignored. The article quoted Gregory as saying "what you see going on in the streets today is nature's way of warning this sick, tired, old degenerate nation that if it doesn't stop and make some quick adjustments, she's going to blow". He further stated "the answers to solving the problems of America are not with dynamite, not with guns. So I say you youngsters have a big job. America is worth saving".

This documents contains neither recommendations nor conclusions of the FBI. It is the property of the FBI and is loaned to your agency; it and its contents are not to be distributed outside your agency.

UNITED STATES GOVERNMENT

Memorandum

TO : DIRECTOR, FBI

DATE: 1/12/71

FROM : SAC, MEMPHIS (157-2650) (P)

SUBJECT: APPEARANCE OF DICK GREGORY
AT MIDDLE TENNESSEE STATE
UNIVERSITY, MURFREESBORO, TENNESSEE,
12/8/70
RACIAL MATTERS

b6
b7c

Enclosed for the Bureau are four copies of a LHM dated and captioned as above, setting forth information regarding GREGORY's appearance at Middle Tennessee State University on 12/8/70.

AGENCY: ~~ICDSC, AIG, OSI, SEC, SERV, TRS~~
~~DEPT. OF JUSTICE, FBI, CD~~
HOW FORW: RS
DATE FORW: 1-27-71
BY: QEE/JP 178090

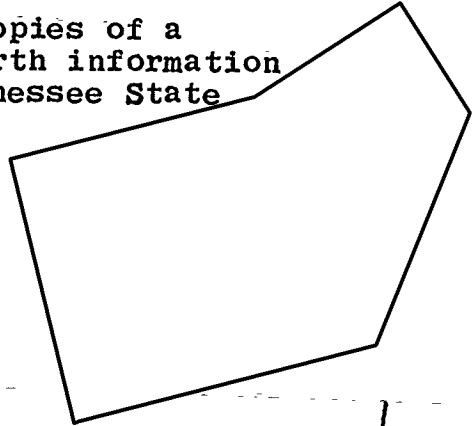

ENCLOSURE

- 2 - Bureau (Encs. 4) (RM)
- 6 - Memphis
 - (1 - 100-5655) (BSA, MTSU)
 - (1 - 157-1755) (BLACK STUDENT ORGANIZATIONS, MEMPHIS DIVISION)
 - (1 - 157-1505)
 - (1-157-1168) (RACIAL SITUATION, MEMPHIS DIVISION)
 - (2-157-2650) (RACIAL SITUATION, MURFREESBORO RA)

VDG:tjm
(8)

REC 27

100-440493-5911

JAN 15 1971

EX-112

RACIAL INT. SECT.



5 JAN 26 1971

Buy U.S. Savings Bonds Regularly on the Payroll Savings Plan



UNITED STATES DEPARTMENT OF JUSTICE

FEDERAL BUREAU OF INVESTIGATION

In Reply, Please Refer to
File No.

Memphis, Tennessee
January 12, 1971

RE: APPEARANCE OF DICK GREGORY
AT MIDDLE TENNESSEE STATE
UNIVERSITY, MURFREESBORO, TENNESSEE,
DECEMBER 8, 1970,
RACIAL MATTERS

On December 14, 1970, [REDACTED]

[REDACTED] Middle Tennessee State University,
Murfreesboro, Tennessee, advised that Dick Gregory spoke
in the Memorial Gymnasium at Middle Tennessee State University
on the evening of December 8, 1970.

b6
b7c

Gregory had been invited to speak on the campus by
the university as part of its "Ideas and Issues" Program.
This program is designed to bring prominent persons to the
campus for speaking engagements throughout the academic year.

Gregory's topic was "Social Problems: Social or
Anti-Social."

[REDACTED] advised that Gregory spoke of the overall
civil rights movement in the United States and urged the
youth of the Nation to become active in solving the problems
of our society. He implored the use of violence as answer
to these problems, however, and stated that the involvement
must take the form of political action.

[REDACTED] advised that Gregory's remarks had been
well received by the approximately 1,000 persons in
attendance and that there were no incidents as a result of
the speech.

This document contains neither recommendations nor
conclusions of the FBI. It is the property of the FBI and
is loaned to your agency; it and its contents are not to be
distributed outside your agency.

100-440423-591
ENCLOSURE

F B I

Date: 1/13/71

Transmit the following in _____
(Type in plaintext or code)

Via AIRTEL AIRMAIL
(Priority)

TO: DIRECTOR, FBI (100-440423)

FROM: SAC, ALBANY (157-253) (P)

SUBJECT: RICHARD CLAXTON GREGORY, aka
Dick Gregory
(AGITATOR INDEX)
RM

(OO: CHICAGO)

ALL INFORMATION CONTAINED
HEREIN IS UNCLASSIFIED
DATE 1-17-80 BY 2842/cjt

On 1/12/71, [redacted]

Hartwick College, Oneonta, New York, stated GREGORY was slated to appear on campus in Binder Physical Education Center on Friday evening, January 15, 1971 at 8:00 P.M. He is to lecture on social problems.

The event is open to the public with no admission charge and is being sponsored by the Academic Cultural Committee of the Student Senate at Hartwick College.

Secret Service, 108th MIG, and USA, Albany, New York, advised.

LHM will follow concerning captioned matter.

- 2 - Bureau (RM)
 - 2 - Chicago (157-347) (RM)
 - 2 - Albany
- RLS/mhc
(6)

ST-109

100-440423-592

58 JAN 20 1971

REC-94

18 JAN 18 1971

Approved: _____ Sent _____ M Per _____
Special Agent in Charge

b6
b7c

V

da

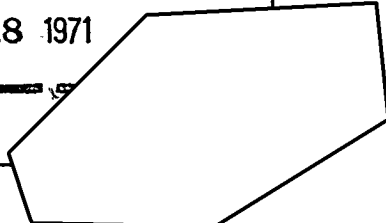

UNITED STATES GOVERNMENT

Memorandum

TO : DIRECTOR, FBI (100-440423)

DATE: 1/19/71

FROM : SAC, ALBANY (157-253) RUC

SUBJECT: RICHARD CLAXTON GREGORY, aka
Dick Gregory
(AGITATOR INDEX)
RM

ALL INFORMATION CONTAINED
HEREIN IS UNCLASSIFIED
DATE 1-17-80 BY 2842/aw

(OO: CHICAGO)

Re Albany airtel to Bureau dated 1/13/71.

Enclosed for the Bureau are eight copies of an LHM concerning captioned individual, with two copies to Chicago regarding appearance of subject, at Oneonta, New York on the evening of January 15, 1971. A copy of this LHM has been furnished to 108th MIG, Albany, New York, and Secret Service, Syracuse, New York.

The confidential source referred to in enclosed

LHM is

[Redacted]

b6
b7C
b7D

- 2-Bureau (Encs. 8) (RM)
- 2-Chicago (Encs. 2) (RM) (157-347)
- 1-Albany
- RLS:dml
- (5)

ST-109
REC-94

100-440423-593

JAN 25 1971

AGENCY: ~~ICBSC, MIG, OSI, SEC. SERV., IRS,~~
 DEPT: ~~ISD, ORD, IDIU, CD,~~
 HOW FORW: RS
 DATE FORW: 1-28-71
 BY: LEE/MP OCCD 17804D

REC'D INT. SEC.

[Handwritten initials]

59 JAN 29 1971





UNITED STATES DEPARTMENT OF JUSTICE
FEDERAL BUREAU OF INVESTIGATION

In Reply, Please Refer to
File No.

Albany, New York
January 19, 1971

RE: RICHARD CLAXTON GREGORY,
also known as Dick Gregory

[redacted] Hartwick College, Oneonta, New York, advised on January 12, 1971, that RICHARD CLAXTON GREGORY was scheduled to appear on campus at the Bandin Physical Education Center Building on Friday evening, January 15, 1971, at 8:00 P.M.. He stated GREGORY was scheduled to lecture on special programs. He stated the event was to be offered to the public with no admission charge, and it is sponsored by the Academic Cultural Committee of the Student Senate at Hartwick College .

b6
b7c

On January 18, 1971, a confidential source, advised he attended a lecture given by GREGORY on the Hartwick College campus at Oneonta, New York, which began at 8:00 P.M. on January 15, 1971 and lasted until 9:30 P.M. He stated there was a crowd of about two thousand students and other people that attended the lecture. He stated the talk given by GREGORY dealt with the way Negro people are treated by the White people in the country. He said the United States is a racist country and he gave background information and declared that the United States is a "White America." He stated GREGORY also talked about the starving people in the United States, the richest nation of the world, and the fact that the Federal Government was not helping the situation.

He stated there was no disorder or any type of violence as a result of the talk.

100-440423-543

ALL INFORMATION CONTAINED
HEREIN IS UNCLASSIFIED
DATE 1-17-80 BY 2842/CC

ENCLOSURE

He stated GREGORY remained at Oneonta, New York the night of January 15, 1971 and departed on the morning of January 16, 1971.

This document contains neither recommendations nor conclusions of the FBI. It is the property of the FBI and is loaned to your agency; it and its contents are not to be distributed outside your agency.

FEDERAL BUREAU OF INVESTIGATION
COMMUNICATIONS SECTION

JAN 15 1971

TELETYPE

REC-10

Mr. Tolson	_____
Mr. Sullivan	_____
Mr. Mohr	_____
Mr. Bishop	_____
Mr. Brennan	_____
Mr. Callahan	_____
Mr. Casper	_____
Mr. Conrad	_____
Mr. Felt	_____
Mr. Gale	_____
Mr. Rosen	_____
Mr. Tavel	_____
Mr. Walters	_____
Mr. Soyars	_____
Tele. Room	_____
Miss Holmes	_____
Miss Gandy	_____

NR002 AL PLAIN

10:22 AM URGENT 1-15-71 MJC

TO DIRECTOR (100-440423)

NEW YORK

CHICAGO (157-347)

FROM ALBANY (157-253) 2P

Deleted Copy Sent
by Letter 10/8/71
Per FOIA Request

① ATK [unclear]

RICHARD CLAXTON GREGORY, AKA DICK GREGORY

(AGITATOR INDEX) RM. OO: CHICAGO.

ALL INFORMATION CONTAINED
HEREIN IS UNCLASSIFIED
DATE 1-17-80 BY 3842/UC

RE ALBANY AIRTEL TO BUREAU, JANUARY THIRTEEN

LAST AND PROPOSED SPEECH BY SUBJECT AT HARTWICK

COLLEGE, ONEONTA, NEW YORK JANUARY FIFTEEN INSTANT.

[redacted] ONEONTA, NEW YORK POLICE

DEPARTMENT ADVISED THAT ON THE EVENING OF JANUARY

FOURTEEN, LAST, A TELEPHONE CALL WAS RECEIVED

AT THEIR DEPARTMENT FROM ONE [redacted]

REPRESENTING

HERSELF ON [redacted]

REC-10

ST-112

100-440423-594

JAN 26 1971

END PAGE ONE

FEB 2 1971

b6
b7c

b6
b7c

6 AC

AL 157-253

PAGE TWO

[REDACTED]
[REDACTED] STATED THAT THEY RECEIVED

A THREATENING ANONYMOUS LETTER WHICH STATED THAT
DICK GREGORY WAS GOING TO BE SHOT WHEN HE LEAVES
HIS HOME. NO OTHER DETAILS OBTAINED BY PD. GREGORY
WILL ARRIVE AT ONEONTA, NEW YORK FOR HIS SPEECH AT
THE COLLEGE SIX FIFTEEN TODAY. THE PLACE WHERE HE
IS DEPARTING FOR TRIP TO ONEONTA UNKNOWN.

ALL LOCAL AUTHORITIES, ONEONTA, NEW YORK,
ARE COGNIZANT OF ABOVE INFORMATION.

NEW YORK CONTACT [REDACTED] ABOVE TO ASCERTAIN IF
EXTORTION VIOLATION EXISTS.

END

PLB FBI WASH DC

CLR

b6
b7C

b6
b7C

UNITED STATES GOVERNMENT

Memorandum

TO : DIRECTOR, FBI (100-440423)

FROM : *RGP* SAC, MINNEAPOLIS (157-386) (RUC)

SUBJECT: RICHARD CLAXTON GREGORY, aka
RM

OO: CHICAGO

DATE: 2-17-71

Enclosed for the Bureau are eight copies of an LHM concerning GREGORY's appearance in the Minneapolis Division at Bemidji, Minnesota.

Enclosed for Chicago are two copies of the above-described LHM.

The source for information in the LHM is the document
Bemidji Daily Pioneer and
 Bemidji State College. MINN.

b6
b7C
b7D

- ② - Bureau (Encl. 8) (RM)
 - 2 - Chicago (Encl. 2) (RM) (157-347)
 - 1 - Minneapolis
- WHM:eje
(5)

Copy to SS/ISA/IDU
by routing slip for
 info action
date 2/25/71
by RME/ld
1cc 8040 3cc

REC-30

EX-114

100-440423-595

16 FEB 22 1971

ENCLOSURE

RACIAL INT. SECT.



70 FEB 26 1971



UNITED STATES DEPARTMENT OF JUSTICE

FEDERAL BUREAU OF INVESTIGATION

In Reply, Please Refer to
File No.

Minneapolis, Minnesota

February 17, 1971

RICHARD CLAXTON GREGORY

On Page One of the Tuesday, February 9, 1971, issue of the Bemidji Daily Pioneer, a newspaper of general circulation, published at Bemidji, Minnesota, there appeared a news article captioned "Youth Has Big Job" concerning the speech of Dick Gregory on February 8, 1971, at Bemidji State College as one in a series of programs sponsored by the Cultural Arts Series of the college. This article is set out in its entirety as follows:

" 'Youngsters, you got a big job before you.'

"With this message, popular black comedian-lecturer Dick Gregory spoke for two hours at Bemidji State College Memorial Hall entertaining and informing some 1200 persons with a multitude of topics ranging from birth control and sex, to women's liberation, black oppression and the Vietnam War.

"Addressing himself primarily to the college age youth in the audience, whom he called 'youngsters,' the popular Civil Rights leader who recently published a third book called 'No More Lies,' concentrated his talk on what he called the 'inconsistencies and myths' of American thought and life.

"The black comedian speaker who was applauded with a standing ovation at the end of his talk began with humorous jibes at Nixon whom he called a 'funny cat.'

ENCLOSURE

100-440423-

595

RICHARD CLAXTON GREGORY

"He said he spent 98 per cent of his time on college campuses because today's youth is 'probably the most morally ethical...group of young people that ever lived,' repeated several times that the solutions to America's problems lies with the younger generation.

"Gregory pointed out inconsistencies in thought of Americans who honor the founding fathers of the country who rebelled against British authority while criticizing young radicals; those who allow Germans who were enemies during World War II to move into their neighborhoods where they would not allow Negroes to live, and those who were angry at the Viet Cong though not at the Russians who 'supply 98 percent of the weapons' used in North Vietnam.

" 'There are inconsistencies,' he repeated several times.

"Some of the topics Gregory commented on:

"George Washington -- 'Washington left in his will to free his slaves after his wife's death...I don't favor celebrating the birthday of a slave master myself.'

"Women's liberation -- 'We men wouldn't let you women take our babies away.' He advised women to teach their sons that peace at even at the cost of imprisonment is worthwhile.

"Life -- 'At five years old I knew what a whore looked like, what a pimp looked like, what a hustler looked like. If I knew at five how is it the government does not know?'

"Radicals -- 'Rather than a list of the radicals in the U. S. why doesn't the government come out with the list of companies that violate the anti-trust laws, the lists of syndicates within our cities...the clauses in the Food and Drug Act that allow them to put drugs in our food that kill us....!'

RICHARD CLAXTON GREGORY

"Nixon -- 'I get up tight when Nixon leaves the country...I always get a sneaky suspicion he might know something. Everytime Nixon leaves the county Agnew becomes number one boy in charge...and he reminds me of the kind of cat that would make a crank call on the hot line to Russia.'"

A source, who has furnished reliable information in the past, advised that Gregory was paid \$1,500.00 for his appearance by the Bemidji State College.

This document contains neither recommendations nor conclusions of the FBI. It is the property of the FBI and is loaned to your agency; it and its contents are not to be distributed outside your agency.

F B I

Date: 2/22/71

Transmit the following in _____
(Type in plaintext or code)

Via AIRTEL _____
(Priority)

TDN

TO: DIRECTOR, FBI (157-8840)
FROM: SAC, NEW YORK (157-1093)(RUC)
SUBJECT: RICHARD CLAXTON GREGORY
 RM-BN

Enclosed herewith for the Bureau and Chicago is one copy each of an article appearing in the February 17, 1971, edition of the "Daily News" regarding captioned subject.

NYO has developed no additional information regarding subject's foreign travel abroad. In view of the above information and the fact this case was re-opened to determine subject's future foreign travel abroad, NYO is closing this case since subject is presently residing in Chicago.

- d*
- 2 - Bureau (Encl. 1)
 - 1 - Chicago (Encl. 1)
 - 1 - New York

7

ENCLOSURE
 (ENCLOSURE ATTACHED)
 (RM)

JAJ:eps
(5)

EX-104

REC-139

100-440423-596

FEB 23 1971

F168

61 MAR 5 1971 / *JAJ*
 Approved: _____
 Special Agent in Charge

Sent _____ M Per _____

Bufile 157-8840
NYfile 157-1093

TO BUREAU

ENCLOSURE (1)



Handwritten initials or mark.

ENCLOSURE
100-441423-596

(Mount Clipping in Space Below)

DAILY NEWS, WEDNESDAY FEBRU

A Thinking Man's GI Tour?

Jane Fonda Plans Antidote to Hope

By JOSEPH MODZELEWSKI

Jane Fonda had a hurt look. Her Bambi eyes got moist like poached eggs when somebody mentioned sex.

"Are you serious?" she scoffed at a reporter who wanted to know if maybe she'd wear a bikini for the troops on her planned tour of United States Army bases to test the Army's liberalization policies on free speech in the military.

"That's what Bob Hope does. We're trying to get away from that sort of thing," Jane said, dismissing the Hope shows as mindless male chauvinism.

The pretty, petulant daughter of Henry Fonda did not say how she planned to entertain the boys, except that there would be no bump-and-grind Barbarella stuff. She is through with all that cheap exhibitionism, she said, dismissing her earlier nude films as "just a stage."

Discusses Her Antidote (cont.)

Jane, together with court-martialed ex-Army doctor Howard Levy, was at the Hotel New Yorker, where she discussed her antiwar antidote to the Bob Hope tour.

The tour—which will star Jane, Elliot Gould, Dick Gregory, Donald Sutherland and Peter Boyle (of "Joe")—was called "a different view on the war."

Calling Hope a "superhawk," Jane complained that the ski-nosed comic has "a corner on the market on entertainers speaking to soldiers." Hope is a golfing crony of President Nixon and Vice President Agnew.

According to Dr. Levy, the antiwar troupe will visit Fort Bragg, N. C., first on March 13.

The Same Old Army? (cont.)

Dr. Levy says, he has not received permission from Lt. Gen. John J. Tolson 3d, Fort Bragg commanding officer, to entertain the antiwar troupe prowling Green Beret military

Fonda is really serious about the antiwar policy. "I don't know how to show on the base," Levy conceded. "I can't do it, and let the public know the Army."

Levy also wants the Army to underwrite the

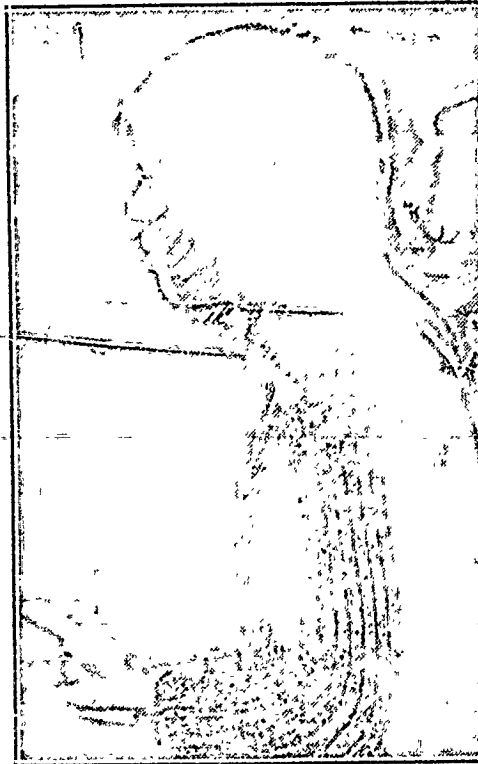

NEWS photo by John Pedin

Will Jane wear a bikini? "Are you serious? ..."

costs of the production, "including lodging and transportation." The USO pays for the Hope show.

In the not-too-unlikely event that the Fonda show bombs in the Pentagon, the cast will still perform their skits in the Haymarket Square coffeehouse, an enlisted men's hangout in Fayetteville, near Fort Bragg.

Film director Mike Nichols is slated to direct the players, who will give a benefit performance under the sponsorship of the United States Servicemen's Fund, which is a sort of pacifist USO.

Indicate page, name of newspaper, city and state.

Page 4, "Daily News" New York, New York

Date: 2/17/71
Edition: morning
Author: JOSEPH MODZELEWSKI

Title: "A Thinking Man's GI Tour?"

Editor: 157

Classification:
Submitting Office:

Being Investigated

F B I

Date: 2/17/71

CSB
RD

Transmit the following in _____
(Type in plaintext or code)

Via AIRTEL AIRMAIL
(Priority)

Big
JFK
TO : DIRECTOR, FBI (100-440423)
FROM : SAC, ALBANY (157-253)
SUBJECT: RICHARD CLAXTON GREGORY, aka
Dick Gregory
(AGITATOR INDEX)
RM

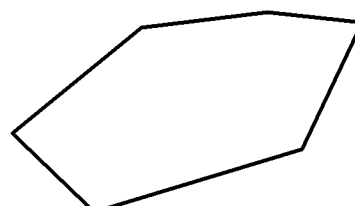

b6
b7C

(OO: CHICAGO) ALL INFORMATION CONTAINED
HEREIN IS UNCLASSIFIED
DATE 1-17-80 BY 2842/EC

b6
b7C
b7D

On 2/16/71, [redacted]
[redacted] Utica College of Syracuse University, Utica,
New York, advised that on February 25, 1971, RICHARD
CLAXTON GREGORY is scheduled to appear in the
cafeteria Strebol Student Center at 8:15 p.m. The
subject of GREGORY's appearance is not known. He
stated that the event will be offered to the public
at \$2.50 per ticket, and to members of the college
community at \$1.50 per ticket. Tickets are being
obtained through the student activity office at the
college. The capacity of the cafeteria is approxi-
mately 1,000 people.

Am

Secret Service, 108th MIG, USA, and local
authorities advised.

LHM will follow concerning captioned matter.

EX-117

②-Bureau (RM) *368*
2-Chicago (157-347) (RM)
2-Albany
FBC/kal
(6)
cc 800
9+D

REC 99 100-440423-597

25 FEB 20 1971

5 MAR 1 1971

Approved: _____
Special Agent in Charge

Sent _____

[Handwritten signature]
M
RACIAL
INDEX

UNITED STATES GOVERNMENT

Memorandum

TO : DIRECTOR, FBI (100-440423)

DATE: 2/27/71

FROM : SAC, ALBANY (157-253) (RUC)

SUBJECT: RICHARD CLAXTON GREGORY, aka
Dick Gregory (Agitator Index)
RM

(OO: CHICAGO)

Re Albany airtel to Bureau, 2/16/71.

Enclosed for the Bureau are eight copies of an LHM concerning captioned individual and two copies to Chicago regarding his appearance at Utica College of Syracuse University on the evening of 2/25/71. A copy of the LHM is being furnished to USA, NDNY, 108th MIG, Syracuse, NY, and Secret Service, Syracuse, NY.

The first confidential source referred to in the enclosed LHM is [redacted] Utica College of Syracuse, NY. [redacted] source is [redacted]

b6
b7C
b7D

- 2-Bureau (Encs. 8) (RM)
- 2-Chicago (Encs. 2) (157-347) (RM)
- 1-Albany
- FBC:kar
- (5)

ENCLOSURE

AGENCY: 157, 101, 20
IRS
DATE FORW. 3-15-71
HOW FORW. BY
BY: RAK for RUC

ALL INFORMATION CONTAINED
HEREIN IS UNCLASSIFIED
DATE 1-17-80 BY 2842/ce

REC-66 100-440423-598

4 MAR 10 1971



316
MAR 17 1971

Buy U.S. Savings Bonds Regularly on the Payroll Savings Plan



UNITED STATES DEPARTMENT OF JUSTICE
FEDERAL BUREAU OF INVESTIGATION

In Reply, Please Refer to
File No.

Albany, New York

February 27, 1971

RICHARD CLAXTON GREGORY
also known as
Dick Gregory

One confidential source who has furnished reliable information in the past advised on February 16, 1971, that GREGORY was scheduled to appear on the campus of Utica College of Syracuse University, Utica, New York, on the evening of February 25, 1971, at 8:15 pm. The subject of GREGORY's lecture is unknown, but tickets to the general public will be offered at \$2.50 each, and to members of the college community at \$1.50 each, and may be obtained through the Student Activity Office at the College.

On February 25, 1971, a second confidential source who has furnished reliable information in the past advised that he attended a lecture given by GREGORY in the cafeteria of the Strebek Student Center at Utica College of Syracuse University, Utica, New York, which began at 8:30 p.m. on February 25, 1971, and lasted until approximately 10:50 p.m. on the same date. Source advised that the presentation was received with moderate enthusiasm by an audience of approximately 750 people. The audience was comprised of approximately 30 percent non white individuals. Source stated that the talk given by GREGORY dealt humorously with topics such as civil rights, ecology, illegitimate births, and student unrest. Source also stated that GREGORY also made humorous, critical quips concerning the President of the United States, the Vice President of the United States, and the activities of the United States Army Intelligence Personnel.

Source stated that there was no disorder of any type resulting from GREGORY's appearance, and to the best of his knowledge, there were no incidents or arrests as a result of the talk.

This document contains neither recommendations nor conclusions of the FBI. It is the property of the FBI and is loaned to your agency; it and its contents are not to be distributed outside your agency.

ALL INFORMATION CONTAINED
HEREIN IS UNCLASSIFIED
DATE 1-17-80 BY 2842/uc

1*

100 - 440423 - 598

ENCLOSURE

UNITED STATES GOVERNMENT

Memorandum

TO : DIRECTOR, FBI (100-440423)

DATE: 3/22/71

FROM : SAC, CHICAGO (157-347) (P)

SUBJECT: RICHARD CLAXTON GREGORY, aka
(AGITATOR INDEX)
RM

OO: CHICAGO

Enclosed are 11 copies of a letterhead memorandum (LHM) dated and captioned as above. No local dissemination being made.

Identification of sources:

CG T-1 is [redacted] (PROB).

Agent who received information from source is [redacted]

LHM is classified confidential to protect a source of continuing value.

AGENCY 150, 100, 55
1A3
DATE FORW. 4-2-71
HOW FORW. 125
BY UAP, RPL, 6007

b6
b7C
b7D

- ③ - Bureau (Enc. 11) (RM)
- 2 - Chicago (1 - A) [redacted]

[REC-7]

100-440423-589

MAR 25 1971

b7D

HHS:cmm
(5)

RECEIVED
MAR 25 1971

5 APR 7 1971



UNITED STATES DEPARTMENT OF JUSTICE
FEDERAL BUREAU OF INVESTIGATION
Chicago, Illinois

In Reply, Please Refer to
File No. 157-347

MAR 23 1971

~~CONFIDENTIAL~~

RICHARD CLAXTON GREGORY,
ALSO KNOWN AS DICK GREGORY

Dick Gregory, comedian, civil rights activist and self-described social critic, made approximately 200 lecture appearances, on college campuses throughout the United States during the academic year, 1970-71. (up to the present date).

The following is personal data concerning Dick Gregory:

Residence	1451 East 55th Street Chicago, Illinois
Employment	Comedian, author, lecturer and owner of Dick Gregory's Products, New York, New York
Marital status	Gregory is married and the father of eight children
Arrest record	Gregory has a record of numerous arrests relating to protest activity, and during the summer of 1968 he served 45 days in prison at Olympia, Washington, the result of a conviction for demonstrating in support of fishing rights of the Nisqually Indians. During summer of 1969, he served 25 days in jail at Chicago,

~~CONFIDENTIAL~~

GROUP I
Excluded from automatic
downgrading and
declassification

This document contains neither recommendations nor conclusions of the Federal Bureau of Investigation (FBI). It is the property of the FBI and is loaned to your agency; it and its contents are not to be distributed outside your agency.

100-440423-599

~~CONFIDENTIAL~~

RICHARD CLAXTON GREGORY,
ALSO KNOWN AS DICK GREGORY

Illinois, the result of a conviction for demonstrating in protest of de facto segregation in the public school system thereat.

On January 20, 1971, CG T-1, who has furnished reliable information in the past, verified Gregory's residence and advised Dick Gregory Products deals in cosmetics for blacks and has been in existence for several years, and recently opened a Chicago outlet, "Dick Gregory Cosmetics, Incorporated, 9528 South Halsted Street, Chicago". This source advised that five percent of Gregory's income from his cosmetic business is donated to the United Negro College Fund.

Summary of Gregory's activities as an author and lecturer during the academic year 1970-71:

Publications

On January 20, 1971, CG T-1 advised that Dick Gregory has a new book on the market entitled "No More Lies", edited by James R. McGraw and published by Harper and Row.

The introductory notes on the jacket of "No More Lies" reads:

"Gregory came by his data in an unusual way - he lived it. He has burrowed in the archives of the minds and hearts of black and white America, hunting not simply for facts but for truth. This book is the result."

This same source quotes Gregory as follows, regarding the book:

~~CONFIDENTIAL~~

~~CONFIDENTIAL~~

RICHARD CLAXTON GREGORY,
ALSO KNOWN AS DICK GREGORY

"I was born in the ghetto of St. Louis, my childhood was one of firsthand experience with all the joys, sorrows, humor and tragedy of poverty."

"I broke onto stage anyway, and, after some hectic moments, received a rollicking response. I went from the depths of poverty to the pinnacle of financial success. Having experienced both, I had to find what really was the meaning to a man's life. People use to ask, 'Have demonstrations hurt your career?', but the only relevant question for me is 'Is my career getting in the way of demonstration?' Active involvement in the struggle for human dignity is the real value in life. A career is secondary.

"I've become increasingly impressed with the fact that the original patriots in this country always ended up on the side of the oppressed, but those who claim to be patriots today always end up on the side of the oppressor. Something is wrong. What is wrong is that America believes her myths rather than essential moral values - the sort of values articulated in America's most basic documents.

"The idea for 'No More Lies' originated and was, in large part, developed in the course of my many college lectures. In these lectures I am continually talking about a country which has lied to the current generation of youth and then when they catch us in the lie, we call it a generation gap. It isn't a generation gap. It's a moral gap."

James R. McGraw is an ordained elder in the United Methodist Church, and has served as a Brooklyn, New York, pastor and now edits Renewal magazine.

Lectures

Reliable confidential sources throughout the United States have reported that Gregory receives approximately \$1,500 for his campus appearances, speaks for approximately two (2) hours on politics, the police, the ghetto areas, hunger in America, Black Nationalists, and persecution of minority groups.

~~CONFIDENTIAL~~

~~CONFIDENTIAL~~

RICHARD CLAXTON GREGORY,
ALSO KNOWN AS DICK GREGORY

Gregory's lectures are well attended, particularly by the white student population, and are terminated without incidents.

Sources conclude that Gregory's speeches, sprinkled with humor and, on many occasions, profanity, are well received. These speeches set forth Gregory's views on the deficiencies of the United States, while he admits he knows of no better place to live.

~~CONFIDENTIAL~~

FBI

Date: March 18, 1971

Transmit the following in _____
(Type in plaintext or code)

AIRTEL

Via _____
(Priority)

~~CONFIDENTIAL~~

b6
b7C

TO: Director, FBI (157-12382)
FROM: SAC, Tampa (157-3163) (P)
SUBJECT: RICHARD CLAXTON GREGORY
RM
(OO: CG)

Re Tampa letter to Bureau, 8/12/70.

On 3/17/71 CS [redacted] advised that the University of South Florida (USF) Lectures and Events Faculty Committee has scheduled DICK GREGORY to speak in the gym of the USF campus Tampa, Florida, at 8:00 PM, Tuesday, April 13, 1971. (U)

b7D

GREGORY'S appearance is part of the regular USF lecture series and his fee will be paid from money allocated by USF for student affairs.

LEAD:

CHICAGO

AT CHICAGO, ILL.

Will advise Tampa appropriate means of covering GREGORY'S speech on a college campus.

- 2 - Bureau (157-12382)
- 2 - Chicago (157-347)
- 2 - Tampa (157-3163)

JAH:jw
(6)

EX-104

REC 70

APPROVED _____
ADVISE _____
SLIP _____
DATE 1-31-80
100-440423-600

CLASS. & EXT. BY 2842 PVD/JPB
1-15-80
REASON-FCIM II, 1-2.4.2, 2
DATE OF REVIEW 3-18-91
Para (c) otherwise (U)

~~CONFIDENTIAL~~

b6
b7C

62 APR 6 1971

Approved: _____ Sent _____ M Per _____
Special Agent in Charge

FBI

Date: 3/24/71

Transmit the following in _____
(Type in plaintext or code)

Via AIRTEL _____ AIRMAIL _____
(Priority)

TO: DIRECTOR, FBI (100-440423)
FROM: SAC, EL PASO (157-176) (RUC)
RICHARD CLAXTON GREGORY, aka
RM - BN
OO: CG

TDN

Enclosed for the Bureau are eight copies and for Chicago two copies of LHM pertaining to the subject's appearance at the University of Texas at El Paso on 3/11/71.

This appearance by DICK GREGORY received local newspaper coverage and no dissemination is being made to local Government agencies.

- ② - Bureau (Enc. 8) (RM)
- 2 - Chicago (157-347) (Enc. 2) (RM)
- 3 - El Paso (1 - 157-176)
(1 - 62-1852) (UTEP)
(1 - 62-1616)

REC-65
 150,110,65
 125,170,65
 DATE FORW. 3-21-71
 HOW FORW. By
 BY SAC JEP 7-0-012

VJA:myg
(7)

EX-104

REC-65 100-440423-6011

8-7 ENCLOSURE

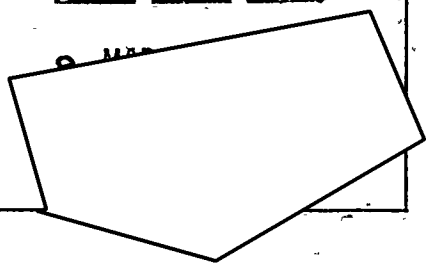

Approved: 62 APR 8 1971
Special Agent in Charge

cc: 804
4 299P

b6
b7c



UNITED STATES DEPARTMENT OF JUSTICE
FEDERAL BUREAU OF INVESTIGATION

In Reply, Please Refer to
File No.

202 U. S. Court House
El Paso, Texas 79901
March 24, 1971

RICHARD CLAXTON GREGORY
RACIAL MATTERS - BLACK NATIONALIST

David Dyer, reporter for "The El Paso Times," El Paso, Texas, reported on March 12, 1971, that Dick Gregory, black humorist, author, and Presidential candidate in 1968, was featured in the University of Texas at El Paso's Lyceum Series on Thursday night, March 11, 1971. Dick Gregory spoke in Magoffin Auditorium on the University of Texas at El Paso campus. He was greeted by a nearly full house.

Following his speech, Dick Gregory held a brief question and answer period with the audience. Concerning any future political plans, Gregory said that at the moment he has none but that he might have in 1972. A reception was held for Dick Gregory in the Student Union Building at the University of Texas at El Paso (UTEP).

[REDACTED] UTEP, advised on March 22, 1971, that Dick Gregory's speech was entirely in a humorous vein and could not be construed as agitational or as advocating violence in any form.

b6
b7c

This document contains neither recommendations nor conclusions of the FBI. It is the property of the FBI and is loaned to your agency; it and its contents are not to be distributed outside your agency.

1*

ENCLOSURE

100-440423-601

FEDERAL BUREAU OF INVESTIGATION
COMMUNICATIONS SECTION

APR 5 1971

TELETYPE

Mr. Tolson	_____
Mr. Sullivan	_____
Mr. Mohr	_____
Mr. Bishop	_____
Mr. Brennan	CD
Mr. Callahan	_____
Mr. Casper	_____
Mr. Conrad	_____b6
Mr. Dalbey	_____b7C
Mr. Felt	_____
Mr. Gale	_____
Mr. Rosen	_____
Mr. Tavel	_____
Mr. Walters	_____
Mr. Soyars	_____
Tele. Room	_____
Miss Holmes	_____
Miss Gandy	_____

NR005 CE PLAIN

6:55 PM URGENT: 4-5-71 ESB

TO: DIRECTOR AND CHICAGO
FROM: CHARLOTTE (157-NEW)

APPEARANCE OF RICHARD CLAXTON GREGORY, AKA. DICK GREGORY, AT
WESTERN CAOLINA COLLEGE (WCC), CULLOWHEE, N.C., APRIL SEVEN,
SEVENTYONE, RM.

[REDACTED] WCC, ADVISED TODAY THAT
RICHARD CLAXTON GREGORY HAS BEEN EXTENDED AND INVITATAION TO
SPEAK AT GRAND HALL, WCC STUDENT CENTER ; ON APRIL SEVEN
SEVENTYONE, AT EIGHT FIFTEEN P.M.

b6
b7C

INVITATION HAS BEEN EXTENDED BY PROFESSOR [REDACTED]
[REDACTED], WCC, AND THE LECTURE, CONFERENCE AND ENTERTAIN-
MENT COMMITTEE.

REC-29 100-44042-368

ADMINISTRATIVE:

15 APR 9 1971

CHICAGO REQUESTED TO VERIFY GREGORY'S APPEARANCE AT
AND ADVISE CHARLOTTE.

END PAGE ONE
"cc to IDIU
Adm. data deleted"

F-309

AK

4-1

2

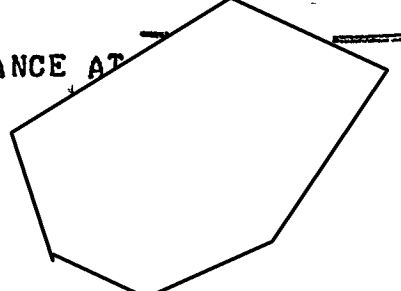

PAGE TWO

ARRANGEMENTS BEING MADE TO AFFORD COVERAGE TO GREGORY'S
APPEARANCE AND ATTEMPTS TO TAPE HIS REMARKS.

CHARLOTE WILL FOLLOW AND KEEP BUREAU AND CHIGAGO ADVISED

END

PLB FBI WA L CLR

REC'D 8 2 5PM
TELETYPE UNIT

cc MR. TRAINOR
ROOM 724 9&D
712-A

FEDERAL BUREAU OF INVESTIGATION
COMMUNICATIONS SECTION

APR 6 1971

Asw
TELETYPE

- Mr. Tolson _____
- Mr. Sullivan _____
- Mr. Mohr _____
- Mr. Bishop _____
- Mr. Casper _____
- Mr. Callahan _____
- Mr. Conrad _____
- Mr. Felt _____
- Mr. Gale _____
- Mr. Rosen _____
- Mr. Tavel _____
- Mr. Walters _____
- Mr. [unclear] _____
- Tele. Room _____
- Miss Holmes _____
- Miss Gandy _____

ph NR 003 CG PLAIN
Bty 109 PM URGENT 4-6-71 MMC

TO DIRECTOR AND CHARLOTTE
FROM CHICAGO (157-347) 1P

~~CONFIDENTIAL~~

~~CONFIDENTIAL~~

⁽¹⁾
RICHARD CLAXTON GREGORY, RM - BN.

See 602
RE CHARLOTTE TEL TO THE BUREAU AND CHICAGO, APRIL FIVE,
NINETEEN SEVENTY ONE.

ON INSTANT DATE, A SOURCE, WHO HAS FURNISHED RELIABLE
INFORMATION IN THE PAST, ADVISED GREGORY TO APPEAR AT WESTERN
CAROLINA COLLEGE (WCC), CULLOWHEE, NORTH CAROLINA, ON APRIL
SEVEN, NEXT. *me*

ADMINISTRATIVE

SOURCE IS [REDACTED]

[REDACTED]

[REDACTED]

EX-103

REC-76

CHARLOTTE SHOULD AFFORD GREGORY'S APPEARANCE SOURCE COVERAGE,
AND REPORT RESULTS TO BUREAU IN FORM SUITABLE FOR DISSEMINATION,
WITH AN INFORMATION COPY TO CHICAGO. *100-446423-603*

END

DRL FBI WASH DC

CLR 3 APR 19 1971 *34*

CLASS. & EXT. BY 2842 PVD/PPB
REASON-FCIM II, 1-2.4.2
DATE OF REVIEW 1-15-80
Para (c) otherwise (u)

~~CONFIDENTIAL~~

b6
b7C

b6
b7C
b7E

b6
b7C

~~CONFIDENTIAL~~

- 1 - Mr. W. C. Sullivan
- 1 - Mr. J. P. Mohr (Creedon)
- 1 - Mr. C. D. Brennan

April 27, 1971

The Attorney General

Director, FBI

RICHARD CLAXTON GREGORY
RACIAL MATTERS - BLACK NATIONALIST

- 1 - Mr. T. E. Bishop
- 1 - Mr. A. Rosen
- 1 - [Redacted]
- 1 - Mr. R. H. Haynes
- 1 - Mr. W. H. Atkinson

b6
b7C

I thought you might be interested in the enclosed memorandum which contains comments recently made at Western Carolina College, Cullowhee, North Carolina, by Richard Claxton Gregory, the well-known comedian and civil rights advocate. Gregory attacked the participation of this Government in the war in Vietnam and ridiculed the President and the Vice President of the United States.

The enclosed memorandum is also being furnished to the Honorable H. R. Haldeman at the White House and the Vice President.

Enclosure

- 1 - The Deputy Attorney General (Enclosure)
- 1 - Assistant Attorney General (Enclosure)
Internal Security Division

REC 18 X-104 440423-600

APR 28 1971

WHA:bjr/cal (14)

NOTE:

See memorandum [Redacted] to Mr. C. D. Brennan, dated 4/26/71, captioned as above, prepared by WHA:glw. Classified "Confidential" since this letter contains information from a confidential source, disclosure of which might be detrimental to national defense interests.

b6
b7C

- Tolson _____
- Sullivan _____
- Mohr _____
- Bishop _____
- Brennan, C.D. _____
- Callahan _____
- Casper _____
- Conrad _____
- Dalbey _____
- Felt _____
- Gale _____
- Rosen _____
- Tavel _____
- Walters _____
- Soyars _____
- Tele. Room _____
- Holmes _____
- Gandy _____

MAILED 3
APR 27 1971
FBI

~~CONFIDENTIAL~~

Group 1

Excluded from automatic
downgrading and
declassification

50 APR 30 1971

MAIL ROOM TELETYPE UNIT

FBI

Date: 4-23-71

Transmit the following in _____

(Type in plaintext or code)

Via AIRTEL

~~CONFIDENTIAL~~

AIRMAIL

(Priority)

TO: DIRECTOR, FBI (157-12382)
FROM: SAC, TAMPA (157-3163) (RUC)
RICHARD CLAXTON GREGORY, aka
RM
(OO:CG)

70R
1-31-80

b6
b7C

Re TP airtel to Bureau, 3-18-71, and CG letter to TP, 3-30-71.

Enclosed for the Bureau are 8 copies of an LHM concerning a speech by GREGORY at University of South Florida (USF), Tampa, Fla., 4-13-71. Also enclosed for the Bureau are 2 copies of FD-376.

Enclosed for Chicago are 2 copies of same LHM.

One copy of this LHM is being furnished to U.S. Secret Service, Tampa, Fla.

Sources referred to in LHM are:

TP T-1 is [redacted] (PROB) 7
TP T-2 is [redacted]

CLASS. & EXT. BY 2842 Pvd/JPB
1-15-80
REASON-FCIM II, 1-2.4.2 2
DATE OF REVIEW 1-23-91 b7D

The enclosed LHM is being classified Confidential because information contained therein if disclosed could possibly lead to the identification of sources of continuing value, which could be detrimental to the national defense interests.

- 2 - Bureau (Encs. 10) (RM)
- 2 - Chicago (157-347) (Encs. 2) (RM)
- 2 - Tampa (1-157-3163) (1-80-139)

ENCLOSURE
REC-2200-440423-605
3-dashed

JAH:mab
(6)

AGENCY: ASST. DIR., OSI, SEC. SERV.
DEPT: ISD, OPS, RAO, IDIU, ICS

APR 26 1971

HOW FORW: _____
DATE FORW: APR 27 1971
BY: *[Signature]*

~~CONFIDENTIAL~~
488 5210

57 MAY 6 1971

Special Agent in Charge

Sent _____ M Per _____



UNITED STATES DEPARTMENT OF JUSTICE
FEDERAL BUREAU OF INVESTIGATION

WASHINGTON, D. C. 20535

In Reply, Please Refer to
File No.

Director
United States Secret Service
Department of the Treasury
Washington, D. C. 20220

April 23, 1971

~~CONFIDENTIAL~~

Dear Sir:

The information furnished herewith concerns an individual who is believed to be covered by the agreement between the FBI and Secret Service concerning Presidential protection, and to fall within the category or categories checked:

1. Has attempted or threatened bodily harm to any government official or employee, including foreign government officials residing in or planning an imminent visit to the U. S., because of his official status.
2. Has attempted or threatened to redress a grievance against any public official by other than legal means.
3. Because of background is potentially dangerous; or has been identified as member or participant in communist movement; or has been under active investigation as member of other group or organization inimical to U. S.
4. U. S. citizens or residents who defect from the U. S. to countries in the Soviet or Chinese Communist blocs and return.
5. Subversives, ultrarightists, racists and fascists who meet one or more of the following criteria:
 - (a) Evidence of emotional instability (including unstable residence and employment record) or irrational or suicidal behavior;
 - (b) Expressions of strong or violent anti-U. S. sentiment;
 - (c) Prior acts (including arrests or convictions) or conduct or statements indicating a propensity for violence and antipathy toward good order and government.
6. Individuals involved in illegal bombing or illegal bomb-making.

Photograph has been furnished enclosed is not available
 may be available through _____

Very truly yours,

J. Edgar Hoover
John Edgar Hoover
Director

1 - Special Agent in Charge (Enclosure(s) (1)
U. S. Secret Service, Tampa

~~CONFIDENTIAL~~

Enclosure(s)

(Upon removal of classified enclosures, if any, this transmittal form
becomes UNCLASSIFIED.)



UNITED STATES DEPARTMENT OF JUSTICE
FEDERAL BUREAU OF INVESTIGATION

In Reply, Please Refer to
File No.

Tampa, Florida
April 23, 1971.

~~CONFIDENTIAL~~

~~CONFIDENTIAL~~

RICHARD CLAXTON GREGORY

On April 14, 1971, TP T-1 and TP T-2 advised that on Tuesday night, April 13, 1971, at 8:30 p.m., Dick Gregory spoke at the Howell Gym, University of South Florida (USF), Tampa, Florida. There were approximately 2,000 persons of college age in attendance, approximately 75 percent of whom were white. Gregory spoke for one hour and forty-five minutes and then held a question and answer session for an additional forty-five minutes. ~~(S)~~ (U)

Sources advised that the main theme of Gregory's speech was white racism, and then Gregory briefly discussed opposition to the Vietnam War. Gregory related his story of the white European American exploitation of minority groups. He stated the white man first exploited the Indians then the Jews, the Italians, the Irish, and finally the "niggers." The white man had exploited the "niggers" for over 100 years until 1968 when a "nigger" like Stokely Carmichael and H. Rap Brown began leading the opposition to white racism. Gregory also said the white man killed his last "nigger" in 1968, referring to Martin Luther King, Jr.

TP T-1 advised that Gregory then told the predominantly white audience that "there is a new breed of 'niggers!'" You white barefooted, long haired, bearded, stinking, hippies - yuppies, whatever they are - you are the

CLASS. & EXT. BY 2842 PVD/PPB
REASON-FCIM II, 1-2.4.2 2
DATE OF REVIEW 4-23-91
1-15-80

ALL AGENCIES
AND FIELD OFFICES
ADVISED BY SLIP(S)
DATE 1-31-80

~~CONFIDENTIAL~~

Para. (C) otherwise (U)

~~CONFIDENTIAL~~

GROUP I
Excluded from automatic
downgrading and
declassification.

100-440423-605

~~CONFIDENTIAL~~

~~CONFIDENTIAL~~

RICHARD CLAXTON GREGORY

new "niggers!" He stated that if 50 of "the new niggers" got explosives and went to a bank and gave the explosives to 50 older people, and the older people blew up the bank, "the new niggers" will be charged. Gregory said the establishment cannot believe that older people would or could be responsible. ~~(U)~~ (U)

According to sources Gregory described the whites in this country as "wild, uncivilized, untamed cowboys." He said, however, violence is not the answer because that is what the white man wants. Blacks have to gain control of black communities by organizing and uniting. For example, blacks could boycott Chevrolet and buy Fords. The people who make Chevrolets would then have to make the necessary changes to accommodate black customers.

Sources advised that Gregory also briefly pointed out the Vietnam War as a great social injustice and praised the opposition of youth to the war.

TP T-1 advised that after Gregory's appearance at the USF, [redacted]

[redacted] held a reception for Gregory

[redacted] The reception was attended by several members of the Afro - American Society, a USF approved campus organization of black students, and several members of the Center for a United Black Community (CUBC), a Tampa, Florida, organization of young blacks for black control of black communities. ~~(U)~~ (U)

b6
b7c

This document contains neither recommendations nor conclusions of the FBI. It is the property of the FBI and is loaned to your agency; it and its contents are not to be distributed outside your agency.

~~CONFIDENTIAL~~



UNITED STATES DEPARTMENT OF JUSTICE
FEDERAL BUREAU OF INVESTIGATION

In Reply, Please Refer to
File No.

Tampa, Florida
April 23, 1971

Title RICHARD CLAXTON GREGORY

Character

Reference Memorandum dated and captioned
as above.

All sources (except any listed below) whose identities
are concealed in referenced communication have furnished reliable
information in the past.

UNITED STATES GOVERNMENT

Memorandum

ma

TO : Mr. C. D. Brennan *Howe*

- 1 - Mr. W.C. Sullivan
- 1 - Mr. J.P. Mohr (Creedon)
- 1 - Mr. C.D. Brennan

DATE: 4/26/71

FROM :

- 1 - Mr. T.E. Bishop
- 1 - Mr. A. Rosen
- 1 -
- 1 -

SUBJECT: RICHARD CLAXTON GREGORY
RACIAL MATTERS - BLACK NATIONALISTS

- 1 - Mr. R.H. Haynes
- 1 - Mr. W.H. Atkinson

- Tolson _____
- Sullivan _____
- Mohr _____
- Bishop _____
- Brennan *Howe*
- Callahan _____
- Casper _____
- Conrad _____
- Dalbey _____
- Felt _____
- Gale _____
- Rosen _____
- Tavel _____ b6
- Walters _____ b7C
- Soyars _____
- Tele. Room _____
- Holmes _____
- Gandy _____

To recommend the attached letters with enclosed memorandum be sent to Honorable H. R. Haldeman, at the White House; the Vice President; and the Attorney General.

The memorandum enclosed with above letters summarizes a speech given by Gregory, black comedian and racist, to students at Western Carolina College, Cullowhee, North Carolina, on 4/7/71. Gregory's speech was recorded by a source and a transcription of the speech reveals he utilized extreme vulgarity against the Director, President, and Vice President. He made his usual caustic scathing comments concerning racism, sex, and law and order.

He attacked U. S. participation in the war in Vietnam and accused the Central Intelligence Agency (CIA) of involvement in the assassination of former President John F. Kennedy. *19*

He also predicted a dictatorship would be established in the country within 18-24 months following overthrow of Government by CIA.

He referred to the Director as "one of the slickest, slimiest degenerate freaks." He stated further concerning the Director "one day you're going to find out about that sick perverted pimp" and "you can't keep a slimy freak like that hid for too long a time."

This is another case where a black racist agitator has been allowed the opportunity to degenerate the morals and values of a college student body.

Enclosures *sent 4-27-71*

100-440423

WHA:glw *glw*
(10)

TELETYPE UNIT
ENCLOSURE
MAY 31 1971
RECEIVED

ST-115
REC-33

3 - ATK [Signature]

100-440423-606
CONTINUED - OVER

62 MAY 4 1971
7227

APR 29 1971

Memo to Mr. C. D. Brennan.
Re: Richard Claxton Gregory
100-440423

The enclosed memorandum will also be disseminated by transmittal form to Secret Service and Central Intelligence Agency.

No dissemination is being afforded Gregory's comments concerning the Director as it is believed such comments are only of interest to the FBI.

ACTION:

That the attached letters with enclosed memorandum be sent to Mr. Haldeman, at the White House; to the Vice President; and to the Attorney General.

WBA *oscar* *B* *WES* *AD* *at* *WBS*
OK
h



~~CONFIDENTIAL~~

UNITED STATES DEPARTMENT OF JUSTICE

FEDERAL BUREAU OF INVESTIGATION

WASHINGTON, D.C. 20535

April 27, 1971

RICHARD CLAXTON GREGORY

Richard Claxton Gregory, the well-known comedian and civil rights advocate, addressed approximately 350 students at Western Carolina College, Cullowhee, North Carolina, on April 7, 1971. A source provided a recording of Gregory's speech. A transcription of this speech revealed it is replete with vulgarities, caustic comments regarding sex and law and order, and accusations of racism in this country. He attacked the participation of this Government in the war in Vietnam. He ridiculed President Richard M. Nixon's physical appearance and the President's motives in releasing Army Lieutenant William L. Calley, Jr., from imprisonment following his conviction for the murder of noncombatants in South Vietnam.

Gregory stated he did not believe it was humanly possible for one man to be as dumb as Vice President Spiro T. Agnew. He claimed Vice President Agnew was consistently dumb and he would not be surprised if Vice President Agnew, during his next television appearance, would refer to President Nixon as "a honkey."

Gregory predicted that a dictatorship would be established in this country within 18 to 24 months following overthrow of the Government by the Central Intelligence Agency. He stated this overthrow of the Government would be predicated upon the failure of the degenerate political forces, the Democratic and Republican Parties, to solve problems which they created.

~~CONFIDENTIAL~~

Group 1

Excluded from automatic
downgrading and
declassification

100-4404-23-606

ENCLOSURE

Richard Claxton Gregory

Gregory alleged that the Central Intelligence Agency was involved in the assassination of former President John F. Kennedy and he condemned President Nixon for not releasing information which would disclose such involvement. He also suggested the United States Government was involved in the murder of former Attorney General Robert F. Kennedy since no prosecutive action has been initiated concerning three unidentified individuals who allegedly were "involved with the gun that Sirhan Sirhan used to murder Bobby Kennedy."

He contrasted the handling by Governmental authorities of those involved with Sirhan Sirhan with the action taken against a black, Angela Davis, for involvement in similar activity. Davis, a self-admitted communist, has been arrested for involvement in the attempted escape of three convicts on August 7, 1970, from a San Rafael, California, courtroom which resulted in the murder of a judge and the killing of two involved convicts and an accomplice.

~~CONFIDENTIAL~~

April 27, 1971

BY LIAISON

- 1 - Mr. W. C. Sullivan
- 1 - Mr. J. P. Mohr (Creedon)
- 1 - Mr. C. D. Brennan
- 1 - Mr. T. E. Bishop
- 1 - Mr. A. Rosen
- 1 -
- 1 - Mr. R. H. Haynes
- 1 - Mr. W. H. Atkinson

b6
b7c

Honorable Spiro T. Agnew
The Vice President
Washington, D. C.

Dear Mr. Vice President:

Enclosed are two copies of a memorandum which I thought might be of interest to you since it contains comments recently made at Western Carolina College, Cullowhee, North Carolina, by Richard Claxton Gregory, the well-known comedian and civil rights advocate. Gregory attacked the participation of this Government in the war in Vietnam and ridiculed the President and the Vice President of the United States.

The enclosed memorandum is also being furnished to the Honorable H. R. Haldeman at the White House and the Attorney General.

Sincerely yours,

WBS
DDS

EX-115

REC 43,00-

440423-607

MAY 29 1971

Enclosures - 2

- Tolson _____
- Sullivan _____
- Mohr _____
- Bishop _____
- Brennan, C.D. _____
- Callahan _____
- Casper _____
- Conrad _____
- Dalbey _____
- Felt _____
- Gale _____
- Rosen _____
- Tavel _____
- Walters _____
- Soyars _____
- Tele. Room _____
- Holmes _____
- Gandy _____

WHA;bjr/cal
(11) b7c

~~CONFIDENTIAL~~

Group 1

Excluded from automatic
downgrading and
declassification

SEE NOTE PAGE TWO

b6
b7c

DELIVERED BY LIAISON
ON 4/27/71
MAY 13 1971
MAIL ROOM TELETYPE UNIT

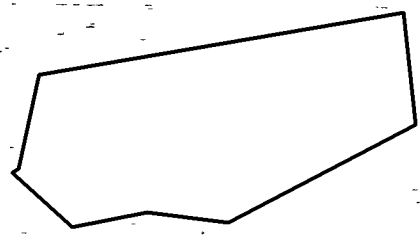

~~CONFIDENTIAL~~

Honorable Spiro T. Agnew

NOTE:

See memorandum [redacted] to Mr. C. D. Brennan dated 4/26/71, captioned "Richard Claxton Gregory, Racial Matters - Black Nationalist," prepared by WHA:glw.

Classified "Confidential" since letter contains data from a confidential source, the disclosure of which would be detrimental to national defense interests.

b6
b7c

~~CONFIDENTIAL~~

~~CONFIDENTIAL~~

April 27, 1971 *for*

BY LIAISON *WBS*

- 1 - Mr. W. C. Sullivan
- 1 - Mr. J. P. Mohr (Creedon)
- 1 - Mr. C. D. Brennan
- 1 - Mr. T. E. Bishop
- 1 - Mr. A. Rosen
- 1 - [Redacted]
- 1 - Mr. R. H. Haynes
- 1 - Mr. W. H. Atkinson

b6
b7C

Honorable H. R. Haldeman
Assistant to the President
The White House
Washington, D. C.

Dear Mr. Haldeman:

I thought the President might be interested in the enclosed memorandum which contains comments recently made at Western Carolina College, Cullowhee, North Carolina, by Richard Claxton Gregory, the well-known comedian and civil rights advocate. Gregory attacked the participation of this Government in the war in Vietnam and ridiculed the President and the Vice President of the United States.

The enclosed memorandum is also being furnished to the Vice President and the Attorney General.

Sincerely yours, ¹¹⁵

REC 18 100 - *WBS*
40423608

ENCLOSURE
Enclosure
5 NO. 6/11/71

WHA:fb/cal

(11)

~~CONFIDENTIAL~~

Group 1

Excluded from automatic
downgrading and
declassification

SEE NOTE PAGE TWO

7 APR 29 1971

b6
b7C

54 MAY 11 1971 RECORDED BY LIAISON
ON 11/28/71

MAIL ROOM TELETYPE UNIT

Handwritten notes and routing slip:
son _____
ivan _____
op _____
nan, C.D. _____
ahan _____
er _____
ad _____
py _____
54 MAY 11 1971 RECORDED BY LIAISON ON 11/28/71

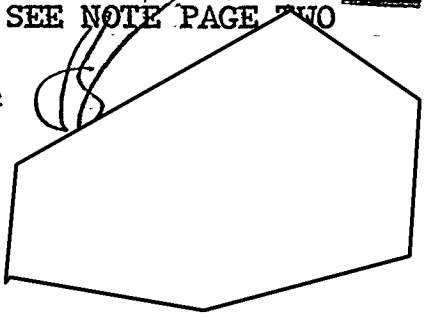

~~CONFIDENTIAL~~

Honorable H. R. Haldeman

NOTE:

See memorandum [redacted] to Mr. C. D. Brennan dated 4/26/71, captioned "Richard Claxton Gregory, Racial Matters - Black Nationalist, " prepared by WHA:glw.

Classified "Confidential" since letter contains data from a confidential source, the disclosure of which would be detrimental to national defense interests.

b6
b7c

~~CONFIDENTIAL~~

~~CONFIDENTIAL~~

- 1 - Mr. Sullivan
- 1 - Mr. Mohr (Creedon)
- 1 - Mr. C. D. Brennan
- 1 - Mr. Bishop

April 27, 1971

RICHARD CLAXTON GREGORY

1 - Mr. Rosen

1 - [Redacted Box]

b6
b7C

- 1 - Mr. Haynes
- 1 - Mr. Atkinson

Richard Claxton Gregory, the well-known comedian and civil rights advocate, addressed approximately 350 students at Western Carolina College, Cullowhee, North Carolina, on April 7, 1971. A source provided a recording of Gregory's speech. A transcription of this speech revealed it is replete with vulgarities, caustic comments regarding sex and law and order, and accusations of racism in this country. He attacked the participation of this Government in the war in Vietnam. He ridiculed President Richard M. Nixon's physical appearance and the President's motives in releasing Army Lieutenant William L. Calley, Jr., from imprisonment following his conviction for the murder of noncombatants in South Vietnam.

Gregory stated he did not believe it was humanly possible for one man to be as dumb as Vice President Spiro T. Agnew. He claimed Vice President Agnew was consistently dumb and he would not be surprised if Vice President Agnew, during his next television appearance, would refer to President Nixon as "a honkey."

Gregory predicted that a dictatorship would be established in this country within 18 to 24 months following overthrow of the Government by the Central Intelligence Agency. He stated this overthrow of the Government would be predicated upon the failure of the degenerate political forces, the Democratic and Republican Parties, to solve problems which they created.

COPIES SENT TO HONORABLE H. R. HALDEMAN AT WHITE HOUSE; VICE PRESIDENT; AG; DEPUTY AG; AAG, INTERNAL SECURITY DIV; SECRET SERVICE; AND CIA.

- Tolson _____
- Sullivan _____
- Mohr _____
- Bishop _____
- Brennan, C.D. _____
- Callahan _____
- Casper _____
- Conrad _____
- Dalbey _____
- Felt _____
- Gale _____
- Rosen _____
- Tavel _____
- Walters _____
- Soyars _____
- Tele. Room _____
- Holmes _____
- Gandy _____

WHA:cal/BJR
(18)
B I
- BEWING E 20H
100 BH 51

~~CONFIDENTIAL~~

Group 1

Excluded from automatic
downgrading and
declassification

SEE NOTE PAGE TWO

b6
b7C

100-44423
ENCLOSURE

MAIL ROOM TELETYPE UNIT

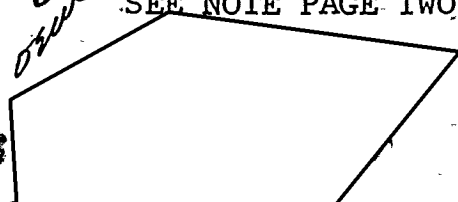

Richard Claxton Gregory

Gregory alleged that the Central Intelligence Agency was involved in the assassination of former President John F. Kennedy and he condemned President Nixon for not releasing information which would disclose such involvement. He also suggested the United States Government was involved in the murder of former Attorney General Robert F. Kennedy since no prosecutive action has been initiated concerning three unidentified individuals who allegedly were "involved with the gun that Sirhan Sirhan used to murder Bobby Kennedy."

He contrasted the handling by Governmental authorities of those involved with Sirhan Sirhan with the action taken against a black, Angela Davis, for involvement in similar activity. Davis, a self-admitted communist, has been arrested for involvement in the attempted escape of three convicts on August 7, 1970, from a San Rafael, California, courtroom which resulted in the murder of a judge and the killing of two involved convicts and an accomplice.

NOTE:

Classified "Confidential" since memorandum contains data obtained from an established source, the disclosure of which would be detrimental to the national defense interests.

See memorandum [redacted] to Mr. G. D. Brennan, dated 4/26/71, captioned "Richard Claxton Gregory, RM - BN," prepared by WHA:glw.

b6
b7c

FBI

Date: 4/15/71

Transmit the following in _____
(Type in plaintext or code)

Via AIRTEL _____
(Priority)

TO: DIRECTOR, FBI

FROM: SAC, CHARLOTTE (157-8185) (P)

SUBJECT: APPEARANCE OF RICHARD CLAXTON GREGORY,
aka Dick Gregory, at Western Carolina
College (WCC), Cullowhee, North Carolina
4/7/71
RM - BN
(OO: CHICAGO)

4-
LTP

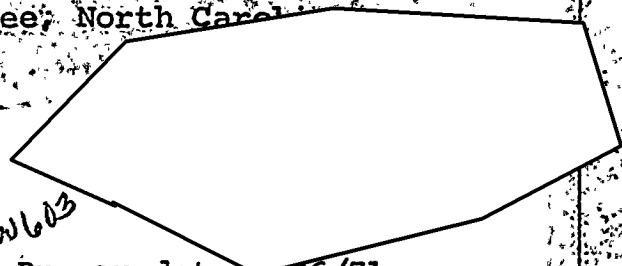

b6
b7C

Re Chicago teletype to Bureau dated 4/6/71.

Enclosed for the Bureau are eight copies of LHM setting forth transcript of tape recording of subject's address. Also enclosed for Chicago are two copies of LHM. One copy of LHM is being disseminated locally to Secret Service.

As scheduled on 4/7/71, GREGORY addressed approximately 350 students at Western Carolina College, Cullowhee, North Carolina, including approximately 70 Negro students from the college.

A tape recording of the speech was furnished by _____ of Western Carolina College. The amount received by GREGORY for his appearance is not known at the present time but according to _____

b6
b7C

- 2 - Bureau (Encs. 8) (RM)
 - 2 - Chicago (Encs. 2) (RM)
 - 2 - Charlotte
- TJB:dmm
(6)

ENCLOSURE
REC-21 100 - 4404

APR 21 1971

WHA: [unclear] 4/27/71
Let to Vice Pres
WHA: [unclear] 4/27/71
Let to [unclear] 1-DAG
WHA: [unclear] 4/27/71 Int Sec Div

to CD Brennan 4/26/71
Memo WHA: [unclear] 4/26/71

Claxton Gregory 4/27/71

Approved: _____
Special Agent in Charge
51 MAY 20 1971

Sent _____ M Per _____

PERS. REC. UNIT

F B I

Date:

Transmit the following in _____
(Type in plaintext or code)Via _____
(Priority)

CE 157-8185

[redacted] but he advised the fee paid to GREGORY for his appearance would not exceed \$500 plus all expenses.

[redacted] advised on 4/8/71 that it would be several days before he could determine the exact amount paid to GREGORY for his appearance and he would obtain this information from the records of the Lecture, Conference and Entertainment Committee.

b6
b7c

[redacted] advised he was present during GREGORY's address and at the conclusion of the address no collections or donations were requested by GREGORY, nor was any money taken for GREGORY.

LEAD:CHARLOTTEAT CULLOWHEE, NORTH CAROLINA

Will recontact [redacted] to determine exact amount paid GREGORY for his appearance at Western Carolina College and advise the Bureau and Chicago.

2

Approved: _____ Sent _____ M Per _____
Special Agent in Charge



UNITED STATES DEPARTMENT OF JUSTICE

FEDERAL BUREAU OF INVESTIGATION

Charlotte, North Carolina

April 15, 1971

In Reply, Please Refer to
File No.

APPEARANCE OF RICHARD CLAXTON GREGORY
AT WESTERN CAROLINA COLLEGE (WCC),
CULLOWHEE, NORTH CAROLINA
APRIL 7, 1971
RACIAL MATTERS - BLACK NATIONALIST

On April 7, 1971 RICHARD CLAXTON GREGORY addressed approximately 350 students at Western Carolina College, Cullowhee, North Carolina. GREGORY had been extended an invitation to speak to the student body at Western Carolina College by Professor [REDACTED] of Western Carolina College and [REDACTED]

[REDACTED] at the university. *NC*

b6
b7c

As scheduled, GREGORY addressed the student body at Western Carolina College Student Center at Cullowhee, North Carolina on April 7, 1971, at 8:15 p.m. GREGORY's speech covered various topics of current interest such as sex, environment, race, the Vietnam War, trial of Lieutenant CALLEY, President RICHARD M. NIXON, Vice President SPIRO AGNEW, FBI Director J. EDGAR HOOVER, and in a portion of the speech GREGORY predicted a dictatorship in the United States which would be initiated and controlled by the CIA within a period of 18 to 24 months. GREGORY accused the CIA of having been involved directly and indirectly in the assassination of JOHN F. KENNEDY and ROBERT KENNEDY. The speech lasted approximately one hour and fifteen minutes.

THIS DOCUMENT CONTAINS NEITHER RECOMMENDATIONS
NOR CONCLUSIONS OF THE FBI. IT IS THE PROPERTY
OF THE FBI AND IS LOANED TO YOUR AGENCY; IT AND
ITS CONTENTS ARE NOT TO BE DISTRIBUTED OUTSIDE
YOUR AGENCY.

ENCLOSURE

100-440423-609

RE: APPEARANCE OF RICHARD CLAXTON GREGORY
AT WESTERN CAROLINA COLLEGE (WCC)
CULLOWHEE, NORTH CAROLINA

The following is a transcript of a tape recording of the speech made by GREGORY at Western Carolina College:

"I would like to say thank you very much. Can you people way back in the cheap seats hear okay? I . . . NIXON is on television tonight, huh? That's a funny cat, man. You know, every time I get really uptight with NIXON myself and every time NIXON leaves the country I usually get a little uptight and I guess it really hasn't got anything to do with DICK NIXON. You see, any time the President of the United States, regardless of who it is, leaves the country I always get a little nervous and upset because I always get a sneaking suspicion he might know something. So I stay a little nervous and upset until he gets back. Not to mention the fact today, with NIXON being the President of the United States, every time NIXON leaves the country, AGNEW becomes the number one boy in charge. That kind of bothers me.

"See, AGNEW just reminds me of the type of cat that will make a crank call to the Russians on the hot line. Other than that, I kind of dig AGNEW myself. But what I mean by that is I don't have the normal hang-ups that most folks have about AGNEW. See, I kind of dig AGNEW because I kind of believe AGNEW is putting everybody on.

"Yeah, I don't believe it is humanly possible for one man to be born that dumb. He, you know if AGNEW was as dumb as he wants us to believe he is, he wouldn't be able to walk and chew gum at the same time. I wouldn't be surprised to pick up the paper one day and read where AGNEW hijacked a train. Tell the conductor, take me to Cuba.

"Of course, you can say anything you want to say about AGNEW but you have got to admit one thing, he's consistent. And I wouldn't be surprised if AGNEW got on television next week and called NIXON a honkey.

RE: APPEARANCE OF RICHARD CLAXTON GREGORY
AT WESTERN CAROLINA COLLEGE (WCC)
CULLOWHEE, NORTH CAROLINA

"Now, I don't mean to scare you young folks or nothing like that. I don't mean to upset you or nothing like that, but you are aware of the fact that AGNEW finished college aren't you? Now, he stated off normal. Yeah, I was talking to one of his roommates not too long ago. He tells me AGNEW is really a dumb cat. Yeah, he told me AGNEW was so dumb that one night all the guys in his dormitory decided to hold a panty raid and said AGNEW was the only cat to come back with a jockey strap. You can't get much dumber than that, right?"

"Let me say it's a pleasure to be with you young folks this evening. I guess I can truthfully say I spend 95 per cent of my time today on college campuses and for a reason. And the simple reason is that you young folks in America today are probably the most morally honest, ethical, committed group of young people that's ever lived in the history of this country, barring none. And I just hope you youngsters don't have to continue to read these old right-wing cracker-controlled newspapers to find out who you are or what you're all about. Because you see, the average established newspaper in America today is not even morally sound enough even to discuss you young kids with yourselves. They call you hippie, yippie, irresponsible, bearded, smelly kids, whatever the hell that means. And my reaction to that has always been, why because you have a beard, why does that mean you have to stink? They don't say nothing about Abraham Lincoln. He didn't only have a beard, he was ugly too.

"I guess what I'm really trying to say to you youngsters in America today is I hope you understand who you are, what you're all about. I hope you don't have to depend on us older Americans to defining you and you actions.

"That's what my new book is really all about. I've been on the college campuses now for five years. It's called 'No More Lies, the Myth and Reality of American History.' And that's what the problem is in America today.

RE: APPEARANCE OF RICHARD CLAXTON GREGORY
AT WESTERN CAROLINA COLLEGE (WCC)
CULLOWHEE, NORTH CAROLINA

For 400 years we lived in a myth in this country and now for the first time you young folks has forced this into reality. We can't deal with it.

"We got a lot of people can't deal with the reality that long hair and a beard is, because see, the myth we've lived in in this country for so long, that we're sick enough and slimy enough and degenerate enough to believe that morality is a Brooks Brothers suit and a clean-shaven face and a haircut once a week. You can commit all the adultery you want to in America as long as you get your hair cut short and shave and press your suits, you're a high, moral, upstanding gentleman. That myth, you got a lot of people that's against long hair and beards not because they're really guilty because they know damn good and well it's a hell of a thing to be born and raised in a so-called free society and know you better not walk in your house with a beard. That's a hell of a thing, baby. Understand that myth now.

"We got a lot of white folks griping today about them beards and long hair act like niggers used to act once upon a time. I don't want to go to them white schools, that nigger was scared. He knew he'd get his ass whooped if he went there. And rather than deal with reality, say I don't want to live in no white neighborhood. We got to deal with reality thanks to you youngsters. Really putting us uptight too.

"There was a time in this country we could always blame everything we didn't want to deal with on the Communists. Because a lot of you Southern white folks is still hung up on that trick more so than your Northern white brother is. It's that nigger bag y'all are in. That's what we used to do. We blamed all kinds of things on the ghosts we didn't understand. The ghost is going to get you. And it's so amusing to look at you white folks in America today reacting to the Communists the same way niggers used to react to the ghosts. Kind of makes you wonder who the nigger is today.

RE: APPEARANCE OF RICHARD CLAXTON GREGORY
AT WESTERN CAROLINA COLLEGE (WCC)
CULLOWHEE, NORTH CAROLINA

"Yeah, just like most of you white folks think there's a communist behind every rock and the nigger used to think there was a nigger behind every tree, a ghost. There's a ghost, there's a ghost, there's a ghost.

"The sad thing, most of these white mentality thinking in America today, I don't mind you blaming stuff on the communists. Why don't you blame something bad on them? Do you realize white folks in America don't blame nothing but good things on the communists? And you march down the street in the morning and say liberate our Indian brother off the reservation. That's communist inspired. What the hell makes you think the Indians, the Russians is interested in getting the Indians off the reservation? March down the street and say feed hungry folks in America and them freaks say that's communist. Why do you blame all the good things on the Russians?

"You know, I wish I could take all these white folks that blame everything, I wish I could take you to Russia with me. I go every two years. Maybe if I could carry you there with me you wouldn't be blaming good things on the Russians because once you go there you find out them cats that run Russia ain't nothing but a bunch of slick, slimy degenerate white folks just like these slick, slimy degenerate white folks that run America.

"You see, there's a lot of people around the world that really don't know what's going down. And they get the news and they believe what they read. Can you imagine if we was living up on some primitive obscure mountain now and we heard about the communists, and every time somebody marched for liberation in America everybody blamed it on the communists, what the hell you think they think about the communists? They say oh man, the communists are behind a lot of good things.

RE: APPEARANCE OF RICHARD CLAXTON GREGORY
AT WESTERN CAROLINA COLLEGE (WCC)
CULLOWHEE, NORTH CAROLINA

"You know, I wonder why the white folks in America don't start blaming some bad things on the communists. You know, any time it snows, blame it on the communists. Every time there's a flood, the communists, the damn communists did that. Every time somebody sticks up a bank we ought to blame that on the communists. Prostitute houses, no that's communist houses.

"I'm so damn sick and tired of you white Americans in this country blaming all good things on the communists. You can't even write a damn book in Russia without going to jail and every time somebody marches in this country for liberation, you white folks want to say the communists
 (next couple of words unintelligible).

"I'd much rather live in America myself than in Russia. At least I know what these political degenerates are talking about. I don't understand no Russian, no. I don't know what niggers sound like in Russian. A cat might be calling me a nigger and I think he's saying good morning. Morning to you brother. (Next word unintelligible.) Morning, same to you and your mama. Whatever it was you called me, I hope it was something nice because I mean it for your mama too.

"You young kids really got us squirming in this country today. You got us dealing with reality. That's a hell of a thing. All your life your mama and daddy got that picture of that Christ boy around the house with that big beard on and that hippie hair, and the first time you come home looking like Christ, they run you out of the house. Yeah. You got to deal with reality.

"You know, there's people in this country wouldn't be caught letting a Jew in their church. How sick that is. Run down to your church every Sunday and that Jew boy nailed

RE: APPEARANCE OF RICHARD CLAXTON GREGORY
AT WESTERN CAROLINA COLLEGE (WCC)
CULLOWHEE, NORTH CAROLINA

to the cross but you don't want a Jew in the church. Are you out of your mind?

"And I'm so glad you young white folks is pushing these folks in this country to deal with reality. Listen, down here in the South, the Southern white brother of yours has really put you in a trick. And you ain't got hip to it yet. He robbed you blind and gave you a nigger to play with, but you ain't going to never get a Boeing 747 in the South. Although your tax money builds airports for that Northern freak to have all them luxuries, but you sure don't get it. And the ones that you are going to get in the South is what that Northern white brother of yours comes to have his holiday in Atlanta, Miami and New Orleans. Mississippi won't get a 747 for 100 years. That's right. Sounds funny, but they got niggers to play with. You got niggers to play with. That's why all your schools are so much worse than them schools up North. You got to be out of your mind.

"Every slave brought to America, when the Northern white ship owners brought the slaves to America and sold them to Southern white folks for top dollar and then one day your Northern white brother said after he got all your money, get rid of the slaves. And you Southerners ain't had enough damn sense to ask for a refund.

"We are really trying to _____ (unintelligible) with the Southern white brothers _____ (unintelligible) because once we get you in line we can go get that vicious freak, baby. Yeah, that damn Southern white boy sold me to you than missed over you and then you're going to jump on me.

"There are people living in the North that are scared to drive through the South because the Illinois license plates have got Land of Lincoln on them. You got white folks that will throw a brick through your car if you got . . . This ain't bad, you know, this cat gets mad, throw a

RE: APPEARANCE OF RICHARD CLAXTON GREGORY
AT WESTERN CAROLINA COLLEGE (WCC)
CULLOWHEE, NORTH CAROLINA

brick through anything he wants to throw it if that's what he wants to do. My hang-up is the same cat that throw a brick through my car because it's got Lincoln's name on the license, that same freak ain't got enough mentality to get rid of the \$5 bills that's got Lincoln's name and his damn picture on it.

"Well, he's missed over. We got to deal with reality now. You youngsters got a big job. Deal with reality, baby, understand what a mess we left you to clean up now. And if you haven't understood, you should understand by what happened last week. I don't care where your loyalty is, you swing with the left or swing with the right, don't be no damn fool. And damn good and well when the United States of America decides to take a confessed murderer of women and kids and old men and make a national hero out of that freak, boy we might be gone beyond the point of no return.

"I just got back in the country and I just couldn't believe that America was reacting behind CALLEY like they reacted behind that murderer. I can sympathize with him. I don't believe it's Calley's fault. If I walk up here tonight and somebody gives me a gun and says when you go up there shoot five people, now it might be their fault, but I did the shooting. I'm the murderer. He admitted he did it.

"Now we ain't talking about nothing somebody's blaming him for. He's the national hero now. That's why the whole world is raging at you. Then the President of the United States took him out of jail and put him in his quarters and the wild thing about that is NIXON is one of them law and order freaks. He ran so hard on law and order in 68, I thought he was running for sheriff instead of for President.

RE: APPEARANCE OF RICHARD CLAXTON GREGORY
AT WESTERN CAROLINA COLLEGE (WCC)
CULLOWHEE, NORTH CAROLINA

"At least them Nazis faked us out with the Nuremberg Trial and made us believe they were sorry about what happened. And we're the ones that handled the Nuremberg Trial. No, I think what NIXON should have done was sympathize with Calley and his family and say he's going to see to it that everybody else go to jail who was involved like General WESTMORELAND and even LBJ. He was head of the Army then. Poor NIXON, this cat, he wasn't even involved. He wasn't even in office. He wasn't even working during the MeLai incident. He didn't have no job. He was unemployed. And now he even got in the White House now and is going to damn near take the rap.

"I really feel sorry for NIXON. It's something, you look at him on television, something about his jaws the way they hang. That's the saddest cat, his jaws hang over. It just makes him look like he's guilty of everything. If there's ever been a man in the history of man that needs a beard, NIXON is that cat.

"NIXON took him out of the stockade. He's back in his barracks now. Before NIXON took him out of the stockade when he was in the stockade he shared a room with another prisoner. Did y'all read about it, any of y'all read about the other prisoner he was with? The other man that was with Calley was in the stockade for forging checks. The check forger is still in jail tonight and the murderer is back in his quarters because this sick, degenerate nation created so much pressure that the number one man in the land instead of acting like a statesman, he acted like a slimy degenerate politician he is.

"The sad thing is, wouldn't this be a wonderful country if we Americans could raise so much hell tonight and put so much pressure on the President he would let the Indians off the reservation in the morning and relieve them from the reservation? Wouldn't that be nice? Wouldn't it be nice if we'd raise so much hell in America and put so much pressure on the President tonight that he'd be forced

RE: APPEARANCE OF RICHARD CLAXTON GREGORY
AT WESTERN CAROLINA COLLEGE (WCC),
CULLOWHEE, NORTH CAROLINA

to deal with feeding 44 million people that go to bed every night hungry? Wouldn't it be wonderful if you Americans was morally committed to the extend you could put so much pressure on the President he'd stop paying billions of dollars to these rich farmers not to plant crops every year in a nation where people are dying from malnutrition?

"And the whoId world is hip to you. It scared England so bad, she sent a formal protest over Sunday. Because England is probably the slimiest of the slimiest of the degenerates, but they do theirs discreetly and America has done pulled the cover off of them. Yeah, oh yeah, them Englishmen went over here and said we deplore your action on letting that murderer go. And England is the boss of murderers.

"I've never understood you American white folks. You don't even know how to be no bigot. But you _____ (next few words unintelligible), get blamed for it. You don't know how to be no bigot. And everybody in the history of the world who had some slaves was able to keep their slaves for 5,000 years. You couldn't keep us in slavery 100 years. You're a lightweight chump.

"And the Englishman is the world's number one bigot but he's learned the one mark of intellectuality, he's learned how to disagree agreeably. The number one killer on the face of this earth is that Englishman. But these heathens over here, they upset London so bad then they just had to say, Hey, wait a minute. Let the whole world know we ain't with them.

"Yeah, I know England was upset, yeah. Even over there in Algiers last week, trying to trick them niggers out of some oil, and America messed up with that Calley trial and

RE: APPEARANCE OF RICHARD CLAXTON GREGORY
AT WESTERN CAROLINA COLLEGE (WCC)
CULLOWHEE, NORTH CAROLINA

took the cover off of them. You youngsters got a big job. My generation is responsible for the Calleys. And your generation with a moral commitment and integrity got to see to it that there'll be no more Calleys in your generation.

"If you think the way of solving the problem of wrong is by rewarding it like it was right, then you let somebody stick up a bank one day and get caught. Say you're all right and let him go. The next day he sticks up another one and kills somebody and gets in the electric chair, which if you had got him and punished him the first time he might be alive today.

"You youngsters got a big job. I say to you you have a big job in America and because the very faith and destiny of America depends on you young folks. Not just in America, all over the world we've left you youngsters a mess to clean up. You can always tell what man has messed up because he always passes laws against it. Anything man dirties up, he passed laws so he don't have to see it. That's why black folks got so many laws passed against us. Man messed us up so bad he don't want to see us. Why do you think the Indians got so many laws passed against them? We dirtied up the Indians so bad we don't want to see them. Why do you think you women got so many laws passed against you? We dirtied you up so bad. Why do you think sex got so many laws passed against it? Because we dirtied up sex and sex organs so bad we don't even want to see it. Anything man dirties up he don't want to see it.

"I'll pull my shoes and socks off and walk out of here tonight at 50 below zero and everybody will say Dick Gregory is crazy. I'll come around the building, come in, take off my tie, my shirt and my coat, my T-shirt, walk out there 50 below zero, nothing on my back, nothing on my chest, barefooted, and say oh, this nigger has really

RE: APPEARANCE OF RICHARD CLAXTON GREGORY
AT WESTERN CAROLINA COLLEGE (WCC)
CULLOWHEE, NORTH CAROLINA

gone crazy. I'll come back in, take off my pants, walk out there with a pair of shorts on, 50 below zero. And everybody says huh huh, civil rights done ran him crazy. I'll come back in and take my shorts off and walk out their naked. I ain't crazy no more. Now I go to jail.

"Why do you think they put me in jail now, because they don't want me to catch a cold? Because I dared show a sex organ that man has dirtied up. Anything man dirties up he don't want to see.

"See, I can walk out there with my chest out and nothing happens. You women better not walk out there with your titties showing the way we dirtied them up. I'm right. And the day we men learn how to dirty up our breasts like we dirtied up yours, that's when we have to put little bandaids on when we go out too.

"Why do we make you women wear all them clothes? We dirtied you up so bad. That's why y'all scared us with them miniskirts. We didn't know what y'all were going to show us. Yeah, that thing kept getting up and up, whew! Well I must say you ladies, we haven't dirtied up your sex organ as much as we've dirtied up ours. Of course, you women are not aware of how much we dirtied up our sex organ because you never get to see us that much.

"If you women could just see men when they go to the men's room. Yeah, it's an awful sight. They you would really understand what we mean when a cat dirties up something he don't want to see it. A cat walks into the men's room, the first thing he does is look around and make sure ain't nobody looking. Then he walks all the way up into the stall and after he gets all way in the stall, he zips his pants down. You can tell when something happens because he starts looking up at the ceiling.

RE: APPEARANCE OF RICHARD CLAXTON GREGORY
AT WESTERN CAROLINA COLLEGE (WCC)
CULLOWHEE, NORTH CAROLINA

"Oh, if the women's lib one night while the men were sleeping could slip into all the men's rooms and put mirrors up on the wall, the cat run there the next morning and say whew, whew! What happened Charlie? I saw it, I saw it, I saw it!

"Anything man dirties up he passes laws against it. That's right. I wawk out here at night and walk across the street and walk up to a tree and zip my pants down and start peeing on the tree. And I really tried to find a way of saying peeing on the tree than peeing on the tree, but there's no other way of saying peeing on a tree than peeing on a tree. I had one old woman one night say you could say passing your water. I said hell, lady, I can spit and do that.

"But I walk up to the tree and zip my pants down and start peeing on the tree. What do you think happens? Here come the cops. All right, put both your hands up. Damn you boy, I said both of them. What you got in your other hand? If I told you you wouldn't believe it. All right, okay officer, okay. Now I go to jail, right? Worldwide news. Dick Gregory arrested, for what? Not peeing on the tree, you know, there's no law against peeing in public. I went to jail for indecent exposure. I dared show a sex organ that man had dirtied up.

"There is no law against peeing. I can stand here tonight and pee in my pants and they can't put me in jail. That's right. As a matter of fact all of y'all could pee in your clothes right there. The state legislature would be upset. That nigger came in and ran them crazy. They peed all over the room. Yeah, we could all go to the airport in New York and get on one of them Boeing 747's and fly to Paris, France and pee all the way across the Atlantic. Dig it now, it's very important what we're talking about.

RE: APPEARANCE OF RICHARD CLAXTON GREGORY
AT WESTERN CAROLINA COLLEGE (WCC)
CULLOWHEE, NORTH CAROLINA

"Man has dirtied up sex so bad that nobody wants to talk about it. Nobody admits they do it. Nobody could get here on the face of this earth without sex. Nobody admits it. How'd you get here Charlie? I was published. Everybody do it and nobody admit it. What did you do last night? Mmmmmmm. We lie to our kids. Kids come and ask us an honest, legitimate question. Mommy, how'd I get here? Oh, ask your daddy. Daddy, how'd I get here? The stork brought you, get the hell out of here.

"We've dirtied up sex that bad. Nobody wants to talk about it. They lie about it. Nobody wants to see the sex organs. Dig it. We're born with sex organs that give us the magnificent ability to recreate human life. Can you believe that man has dirtied up this so bad that nobody wants to talk about it? Do you believe that the only people that would have the ability to have babies, you have to be worth 50 million dollars and pay 10 million dollars to go way up on a mountain and let a certain sun shine on you and then you could give new life. Oh, everybody would say oh, how wonderful that is. But you know, the poorest and the richest man can create new life, and we dirtied up sex organs so bad.

"Have you ever asked yourself how can the creation be dirty? How can a sex organ that gives you the ability to create new life be so dirty that you passed a law that if somebody shows it they go to jail? I'll tell you how. Man did not use his sex organs for creation. He uses it for recreation. Yeah, that's why we got all the hang-ups now.

"I say to you youngsters tonight in America, you have a big job. Yep, the very faith and destiny of America depends on you. Oh, you heard them talking about the many problems confronting America today. Many people seem to think some of the problems can't be solved. I say to you young folks in America today that every major problem

RE: APPEARANCE OF RICHARD CLAXTON GREGORY
AT WESTERN CAROLINA COLLEGE (WCC)
CULLOWHEE, NORTH CAROLINA

in America tonight was created by man, which means these problems can be solved overnight if you young folks decide to solve these problems with honest, ethical statesmanship ability and not this sick, tired degenerate political muscle.

"That's what the problem is in America today. The same slimy, degenerate political forces that's created all the problems is now telling us they can't solve them. You're damn right. Hell, the Democrats and the Republican party is too degenerate and unfit to govern this country any more. That's why America is about 18 months to 2 years away from a dictatorship. I know that sounds strange to you now. You ain't going to believe it now because you're so busy in little petty things you can't see the handwriting on the wall. Every newspaper in America ran the story that every governor in America had a tap on his phone. Who in the hell do you think is tapping the governor's phones in America? The Black Panthers? Congressmen are complaining now J. Edgar Hoover is tapping their phones. What do you think all that's about?

"And that's another sad mark on the American mentality. People all over the world know J. Edgar Hoover is one of the slickest, slimiest degenerate freaks that's walked the face of this earth, and you damn Americans got that freak all built up like he is the ideal American image. You've got to be out of your mind. One day you're going to find out about Hoover. One day you're going to find out about that sick perverted pimp.

"Yeah, it sounds funny because you don't know about him and it don't do any good for me to tell you about him because where your mind is, you wouldn't even believe it. But it's going to break because you can't keep a slimy creep like that hid for too long a time. He's been in

RE: APPEARANCE OF RICHARD CLAXTON GREGORY
AT WESTERN CAROLINA COLLEGE (WCC)
CULLOWHEE, NORTH CAROLINA

his halo for 40 some years perpetrating his slimy tricks on the American public. You're going to find out about him now. It's going to blow a lot of your minds.

"And when the CIA overthrows this government we can't blame nobody but ourselves, other than young kids, but us old folks. The last 100 years every time we go to the polls to vote, for 100 years every time we go to vote, we end up voting for the lesser of the two evils. Try that for 100 years. You've got to end up with the evil or the evil.

"You just watch that political arena. In order to become a U. S. Senator today you must spend 2 million dollars campaigning to get a 55 thousand dollar a year job. Hell, I know people can't even count got enough sense to figure that out. And Rockefeller in New York City spent 8 million dollars campaigning to become the Governor of New York again. Hell, for 8 million dollars I could have ran for God, and won.

"Oh, that's another trick we have made out of this country. We have really made a trick out of God. We start off tricking with God with little kids five years old. I pledge allegiance to the flag of the United States of America, one nation, under God. You got to be out of your mind. Do you really believe this is a nation under God? Why, at this very moment we got Indians across this country locked up on reservations going through some inhumane conditions unparalleled any place else in the world and you are really slimy enough and sick enough and degenerate enough to believe that this honkey country is a nation under God. There isn't another country in the world where the people that harvest the crops is dying from malnutrition, like here in America. I tell you one thing, if this really, truly is a nation under God, I sure as hell would hate to see one under the devil.

RE: APPEARANCE OF RICHARD CLAXTON GREGORY
AT WESTERN CAROLINA COLLEGE (WCC)
CULLOWHEE, NORTH CAROLINA

"And since NIXON wants to be such a good American, there's a whole lot of things he could be doing for this country other than letting some murderer out of jail. He could have got you out of Vietnam. Sitting and reading the paper today, Senator said he believed NIXON's speech is going to announce that by 1972 they're going to withdraw all the troops. Do you believe, I mean these young kids, do you know what that means? That means they're going to keep you youngsters in Vietnam getting you killed until it gets time to election and then they're going to bring everybody home. If that ain't a damn shame. He can bring you out to help win an election, but he can't bring you out to help keep you alive. If the federal Presidential election wasn't to be held again until 1980, we wouldn't even consider coming out of Vietnam until 1979.

"If NIXON really wants to do something for Americans, what he should do is get on television one night and release a list of all the dope pushers in America. Yeah, that would be _____ (unintelligible). And don't think NIXON couldn't find out who the dope pushers are if he wants to. I don't think I've ever been in this town before. I haven't been here two hours yet, and I could leave here now and go out and find some connections to make me some stuff. I know if I can coming to this old hick town and make connections in fifteen minutes to get some stuff, as dumb as I am, I'm sure NIXON with all his intelligent boys can find all the pushers across the country. Damn Army would not admit they're running dossiers and files on 25 million Americans. I can't believe that they ain't got no dope pushers in the files. I can't believe they got everybody but the dope pushers. So, if he wanted to know who's pushing the dope all he's got to do is go and ask the Army. Say, give me your dossiers on the dope pushers. Say, well we haven't got them. Say, well who're you watching, Priests?

RE: APPEARANCE OF RICHARD CLAXTON GREGORY
AT WESTERN CAROLINA COLLEGE (WCC)
CULLOWHEE, NORTH CAROLINA

"If NIXON really wants to do something to help this country to show his patriotism to American Americans, what he ought to do one day is walk down to the Pure Food and Drug Administration and get that list of additives and chemicals and poisons that the federal government permits the food chains to put into your food that's wiping you out every day. To release that list to you. Yeah, that would do you a lot of good.

"I'm sure us Americans would be much better off knowing that there are documented evidence in the Surgeon General's Office, been there for twenty years, that proves beyond the shadow of a doubt that there is more stomach cancer caused in America every day from drinking coffee than lung cancer from smoking cigarettes. And I'm sure you coffee drinkers would be happy to know that wouldn't you?

"As a matter of fact, if NIXON really wanted to do something, what he should do is release that real cigarette report. Because y'all are down here in North Carolina where they perpetrated that trick. I bet y'all don't even know about it. Some of you probably do. I'll bet if they gave you that real cigarette report, baby, I'll bet you would have quite smoking overnight. Yeah, that report that scared a couple of people, that was the compromise report. So you can imagine what the real one was all about, couldn't you? Cigarette smoking causes cancer--that's the second most detrimental effect. If they had told you the number one effect tobacco has on the human body, I'll bet you would have give them up. If they had told you the number one detrimental effect tobacco and nicotine have on your body, it destroys your sex organs, I'll bet you would have quit smoking overnight if you could have got that true report, don't you?

RE: APPEARANCE OF RICHARD CLAXTON GREGORY
AT WESTERN CAROLINA COLLEGE (WCC)
CULLOWHEE, NORTH CAROLINA

"That's why the Russians, every now and then you read in the paper where the Russians, 80 per cent of the Russians, quite smoking overnight. They sure are strong. They ain't strong. The Russians just released the real report. Hell, you'd quit too. That's right. I don't have to tell you right here in North Carolina.

"You hear the cigarette company keep saying cigarettes, don't you hear them saying tobacco don't cause cancer? You've heard them make that statement? They ain't lying. Tobacco do not cause cancer. No, cigarette smoking causes cancer.

"Let me explain it to you. You in this state, you really should know it. You ever been around anybody smoking Bull _____ (unintelligible)? You notice when you put the Bull _____ (unintelligible) down on the ashtray and quit puffing on it it goes out? You ever notice that? Have you been around anybody smoking a pipe? And when you quit puffing on the pipe the tobacco goes out. It is normal for tobacco to go out when you ain't puffing on it. I tell you what's causing cancer in your chest, these stinking, filthy, degenerate cigarette industry folks decided they're going to come up with a way to make your cigarette burn when you wasn't puffing on it, being that it's normal for tobacco to go out when you ain't puffing on it and it's the damn chemicals that they add to the paper and the chemicals they add to the tobacco to make your damn cigarette burn when you ain't puffing on it is what's causing cancer of your chest and the federal government knows about it because they okayed them slimy, degenerate freaks.

"That's what we're talking about. How come you Americans can't find that out, since we got a President that's so patriotic and so . . . ?

RE: APPEARANCE OF RICHARD CLAXTON GREGORY
AT WESTERN CAROLINA COLLEGE (WCC)
CULLOWHEE, NORTH CAROLINA

"As a matter of fact, if NIXON really wants to do something to help America one night while everybody in Washington, D. C. is asleep, why don't he slip down there to the building where the archives is kept and take the hinges off the door and get that JOHN KENNEDY file and get on television early one morning and explain to you Americans what is in the JOHN KENNEDY file that is so horrifying they can't release it to you for 100 years. I'm sure America would be much better off tonight knowing that the CIA was involved with the assassination of your President than having some murderer send out of the stockade back to his quarters.

"You youngsters got a big job. And you haven't got much time. Just keep your eye on them politicians. I'll be honest with you. I could never vote for DICK NIXON but I sure am glad he is President. I don't know no man alive today I'd rather see get President other than DICK NIXON. That's right, I mean it. I couldn't have voted for him, but see I looked at DICK NIXON when he was campaigning. He just had, I could just tell the way he looked if he ever became President of the United States he sure was going to put a hurting on white folks. You know, I don't have to tell you. You know white folks is hurting more today in this country than ever before in the history of America. I go across the country every day. I see more white folks crying today than ever before. I see white folks doing things I used to see nobody doing but niggers, shaking their head.

"I didn't realize how bad things was until this morning. I jumped on the plane and was walking to my seat and an old white cat sitting there looked at me and said can I speak with you my brother. I said your what? Things got so bad I'm your brother now. And when everything was all right I was the nigger and the coon. Things got so messed up I'm the brother now.

RE: APPEARANCE OF RICHARD CLAXTON GREGORY
AT WESTERN CAROLINA COLLEGE (WCC)
CULLOWHEE, NORTH CAROLINA

"So I looked at him and said yeah, what's happening my man? He said they're really messing up all of us. I said who, the Black Panthers? He said no, NIXON and them. I said I don't even want to discuss that. That's white folks' business. He said well he's messed up the money, it's black folks' business too. I said what do you mean by that? He said black folks ain't got no money. I said don't bother, whatever money we ain't got y'all can't get. He said but I was reading in the Wall Street Journal this morning that at the rate we're going we're headed into another depression. I said y'all might be. We never came out of the last one. Oh, NIXON has messed with the money and you ain't seen nothing yet before he gets through with us, before 72 gets here that silent majority is going to be one of the most vocal groups you ever heard in the history of America. And not another man on the face of this earth would have become your President and got to messing with your jolly green Jesus.

"Oh, we know what your God is in this country and you fake out and got all them churches on every corner and wearing all them old crosses and that old cross on the hill comes in it now. The whole world is hip to you, knows what your God is. I've always wondered what is inside of these churches other than God that makes them lock them up at night so I can't steal it. I tell you what, I tell you what your jolly green Jesus is, that damn Calley, that damn Calley not would have gone to Vietnam had he taken him a flame thrower and walked into the New York City and walked into the Chase Manhattan bank and burned up all the money, they'd have had his ass so far under that jail tonight you'd have to pump air down to him. I know what you God is in America.

"What do you think would have happened to Calley had he not killed them people in the ditch, if he carried them bazookas to the Space Center and _____ (unintelligible) and blew up that moon rock?

RE: APPEARANCE OF RICHARD CLAXTON GREGORY
AT WESTERN CAROLINA COLLEGE (WCC)
CULLOWHEE, NORTH CAROLINA

"If you want to know what your God is in America Sunday morning when you go to church, this is your good freak-out day for church, oh everybody people that don't even mean it will be going Sunday. On your way into your church Sunday, on your way in, pull out a good old piece of American folding money and hold it right next to your church and see which one of these institutions you're going to find in God we Trust inscribed on it, your money or your church. This is your God. If you don't believe that, you let the churches in America decide next week we ain't going to church on Sunday no more, we're going on Monday. See who will have the most people in them next Monday, the factory or the church.

"Oh, we love the money. This is one of the few countries in the world you can kill your mama, get you some money, get you a good lawyer, walk into an American courtroom and plead temporary insanity and you damn near beat the case every time. I tell you what you better not do in America. You better not forge no check and get caught and get you a lawyer and walk into an American courtroom and try to plead temporary insanity. You kill your mama, you might be crazy, boy. You mess with the money, you got good sense and we're going to put you in jail. Oh yeah, we love the money.

"You know, you do in this country, now you can slip in some old woman's house tonight and take a poker and hit her in the head and beat her to death and rob her and get a nickel. Tomorrow morning when America finds out you killed that old woman over a nickel this country would be outraged. Killed that old beautiful woman over a nickel. You ought to give him the electric chair without a trial. Slip in that same old woman's house tonight and rob her and hit her in the head with a poker and kill her and get 10 million dollars. Tomorrow morning when America finds out about that money, everybody in this country would be saying she had no business with that kind of money around the house.

RE: APPEARANCE OF RICHARD CLAXTON GREGORY
AT WESTERN CAROLINA COLLEGE (WCC)
CULLOWHEE, NORTH CAROLINA

"I say to you youngsters tonight in America, you got a big job. That's really what black folks is talking about in America today. Really talking about white folks reaction to us. I swear to you, we don't understand white folks' reactions to us today. All at once you got a lot of white folks saying niggers have gone crazy. What's wrong with them? I tell you one thing, niggers got more sense today in America than ever in the history of this country. When niggers were truly crazy, that's when most white folks thought we had some sense. Come here _____ (unintelligible), come here nigger. That's when niggers were crazy, but most white folks loved us then.

"Now, everybody wonders what's wrong with us. Damn good and well what's wrong. Any old blatant idiot knows America is a racist country that oppresses folks. And what's wrong with us? We're reacting to the racism and the oppression, that's all. I could understand white folks getting uptight in America if we were saying to white America, you can't be a racist no more. Hell, I'd be upset too if I had been _____ (unintelligible) that long and somebody told me I had to quite. I can understand America being upset tonight if we tell America you can't oppress folks any more. We have not told America to stop oppressing people and we've not said to white folks you can't be a racist any more. All we've said is we're going to react to racism and oppression, that's all.

"And you run up here tonight and cut my wrists, I might not do nothing back to you, but my God don't get all uptight because I'm bleeding on your rug. Just look at them niggers. Every time you cut them they just bleed on your rugs.

"And one big problem in America, a lot of white folks been playing that nigger's game a little too long. Henry Cabot running around calling me the nigger and the coon as long as I

RE: APPEARANCE OF RICHARD CLAXTON GREGORY
AT WESTERN CAROLINA COLLEGE (WCC)
CULLOWHEE, NORTH CAROLINA

was bleeding and that was all right. You got a lot of white folks in America that believe that I'm a nigger and a coon. Because you believe something about me, don't make it true. What do you think, would happen in America in the morning if all white folks woke up believing every black person in the black ghetto got 10 million dollars. Do you think that would make us rich, just cause you believed it? See, a lot of people don't understand that the same universal intelligence bank that put white folks head together also put black folks head together.

"And that's what my problem is in America today. It's the universal intelligence we have in our head that makes us react to these insults. You know how insulting it is to me some nights when I'm laying in my bed trying to go to sleep and I get to thinking about how a German killed my daddy during World War II. A german killed my father in 1942. I was 10 years old then. I'm 38 years old now. That means I would have gone 28 years without a daddy which really ain't no insult, because when daddies go to war they got to kill or be killed. The insult is that the same German that could have killed my father in 1942 and made me go 28 years without a daddy, that same German tonight you would permit to come to my daddy's country and live in a neighborhood you would not permit my daddy's boy in. We say you got to be sick, insane and out of your damn mind.

"And that's what we're reacting to. And that's your racism baby, your insanity. We're tired of these insults. We're not saying don't insult us. All we're saying is please have enough integrity to understand what we're going when you see us running out here. We're reacting to these insults.

"Angela Davis in jail tonight. I don't believe Angela Davis is in jail because she's black, no. Just check the records. You'll find out any time honest, decent folk

O Q

RE: APPEARANCE OF RICHARD CLAXTON GREGORY
AT WESTERN CAROLINA COLLEGE (WCC)
CULLOWHEE, NORTH CAROLINA

book sick degenerate systems, they not only put you in jail, they'll kill you too. If you don't believe that, ask John Brown. Can't get no whiter than him. And the insult about Angela Davis is the fact that America has invited eleven white Russians to America to sit in on the Angela Davis trial but haven't invited no black folks. They invited eleven white fonkey Russians that don't give a damn about you or your white system, baby. Kruschev already told you, of course a lot of you might have been a little young when he said this, he said he could have buried you when he was Premier, he'd have been happy. That don't mean nothing. You can relate with white, yeah, regardless of what they're going to do to you.

"I wonder what America's reaction would have been had Lieutenant Calley been a Vietnamese and them folks in the ditch been American white folks. It would have been a different ball game then wouldn't it? You know, if them eleven white Russians decide to take America up and come to America for the Angela Davis trial, do you know they wouldn't search one of them Russians walking in that courtroom every morning like they'd search me? And dig it, baby, I would never say my ethics is any higher than the highest ethical man walking the face of the earth but I'll say this, my ethics is as high as the highest, most ethical man walking the face of this earth and if anybody don't need searching going into a courtroom, I'm one of them.

"I say we're tired of these insults. Angela Davis was arrested under California law that says if you're involved with a crime in any shape, form or fashion, you don't even have to be on the scene when it is committed, they can indict you and prosecute you for the same crime just like you was there. Now, I don't know enough about law to know if that state law would hold up in the U. S. Supreme Court but I got enough universal intelligence in my head to know one thing, that Sirhan Sirhan was apprehended, indicted, tried and convicted.

RE: APPEARANCE OF RICHARD CLAXTON GREGORY
AT WESTERN CAROLINA COLLEGE (WCC)
CULLOWHEE, NORTH CAROLINA

in the state of California for the assassination murder of BOBBY KENNEDY, and in the course of the Sirhan Sirhan trial it came out in open court that there was three other people involved with the gun that Sirhan Sirhan used to murder BOBBY KENNEDY with, but to this very day in the state of California no one but Sirhan Sirhan has been indicted and apprehended and convicted for the murder of BOBBY KENNEDY but Sirhan Sirhan. This is what we're talking about.

"We're talking about these insults. Every major black community in America today the police patrol our communities with double barrel shotguns. Listen to me good now. Double barrel shotguns was outlawed in the Geneva Convention as a weapon of war because they were deemed too inhumane. Police forces in this country will come in my black community with a double barrel shotgun, a weapon that this country would never be permitted to use on your front line of battle towards your most vicious enemy. Now we're not saying to white America to tell your cops to get your double barrel shotguns out. We ain't saying that. The insult is when Americans ask black folks to have respect for your local police, how in the hell do you thing I'm going to respect the man that carries a weapon through my community that you wouldn't be permitted to carry on the front line of battle and shoot a Viet Cong? You've got to be out of your mind.

"We're saying we're tired of these insults. We're tired of the insults of civil rights legislation. Do you know how insulting that is? You white folks in America are going to get your rights from the U. S. Constitution. We black folks are going to get ours on the civil rights bill. Hell, that's racial segregation. We are making progress. If it's so good, why don't you take it home and give it to your mama? All that civil rights legislation means today

RE: APPEARANCE OF RICHARD CLAXTON GREGORY
AT WESTERN CAROLINA COLLEGE (WCC)
CULLOWHEE, NORTH CAROLINA

is for 100 years the man has changed my dollar for 32 cents and now today he's giving me 64 cents, but the difference is I can count today. I don't want no 64 cents change for a dollar. I'm going to stop the cheat. I'm going to get me a full dollar's change for a dollar or I'm going to try to fix it so this cash register would never ring again.

"As you read that civil rights legislation it gets even more insulting. Take that 1964 Public Accommodations bill that the Senate and the Congress passed. The black folks have a right to sleep in any motel, black folks have a right to sleep in any hotel, black folks have a right to eat in any restaurant, but when it came to bars and taverns we weren't covered. Now why do you think they didn't cover us under bars and taverns in the 64 Public Accommodations bill? Do you think the Senators and Congressmen know how bad alcohol is on the body and love black folks so much they didn't want us getting involved? I tell you why we weren't covered under that 64 civil rights bill with bars and taverns because that white woman goes in them bars and taverns and you know it's enough sixk white mentality in this country to believe that when the white woman gets two shots of alcohol in her belly she wants to give me her body. And what we're trying to say to white America since that white sister of yours seems to be your damn hang-up, why in the hell didn't you pass a law to keep her out of them taverns and leave me alone?

"That's what we're talking about. We're talking about we're tired of these insults. And now we're getting a lot of white folks coming to us saying what y'all want us to call y'all? Negro or colored or black? You can call us anything you want to call us. We're just saying it's safe to use the word black. And we don't mean to put no white Americans in no imposition or nothing like that, but we've looked around at you and we notice you white folks have little tag names y'all call one another for identification and if you take that little tag name and stretch it all the

RE: APPEARANCE OF RICHARD CLAXTON GREGORY
AT WESTERN CAROLINA COLLEGE (WCC)
CULLOWHEE, NORTH CAROLINA

way back it will always end up going to a piece of land. German--Germany, isn't that clever? Italian--Italy, ain't that it? Let's try one. Irishman--Ireland. Negro--who? Negro takes me back to a sharecropper's shack. And so all we say is just call me black. And if nothing else, I can identify with night time.

"Understand we're tired of these insults. We're tired of the inconsistencies. Do you realize the inconsistencies white folks use in this country? George Wallace came up North in the last Presidential election and got so many white folks to vote for him they blamed him on us. How come you think George Wallace got so many votes from white folks up North? Bunch of bigots, hell no. Black folks created a white backlash. That's what did it. Oh you ain't seen nothing yet till NIXON gets through with you in 72. You're going to blame him on us. I can just see it now, if you niggers hadn't scared us, we wouldn't have voted for him.

"I'm talking about the inconsistencies, about the inconsistencies of the ways we fight wars today. I really learned a lesson last month. For the first time in my life I realized last month that you can take your mighty Air Force to another man's country and bomb the hell out of him but as long as you don't use no ground troops, it's not considered an invasion. That's an incursion (phonetic). And what upset me, is I got to realize how smart the Japanese was back in 1941. They didn't use no ground troops. Their air force bombed Pearl Harbor and we were so dumb and stupid we thought it was an invasion and declared war on them folks.

"I didn't know what incursion meant until about ten days ago. It means you going to get whooped. And NIXON sure got caught in the tree. He's sitting on the television said yes, the Laotian incursion is coming along just as we expected it. The same time he's saying that the South Vietnamese

RE: APPEARANCE OF RICHARD CLAXTON GREGORY
AT WESTERN CAROLINA COLLEGE (WCC)
CULLOWHEE, NORTH CAROLINA

is getting whooped so bad they're jumping on the outside of the plane trying to get out. Now you know it's bad enough to jump on the outside of a plane to just land, but hell, they jump on the outside of a plane that's fixing to take off.

"I'm talking about these inconsistencies, about the inconsistency of World War II. World War II we fought the Japanese and the Germans. There were German citizens living in America and there were Japanese citizens living in America. We arrested all the Japanese citizens in America but not all the German citizens in America. We're talking about these inconsistencies. Put all the Japanese in jail but no Germans. I believe we did that because America is a racist country. Now I might be wrong.

"I'm talking about the inconsistencies, talking about the inconsistency of the Vietnamese war. And the way we Americans feel towards the North Vietnamese and the Viet Cong that every time one of your red-blooded American boys gets shot down over the skies of Hanoi with a Sam (phonetic) missile, he got shot down with a missile that was made, manufactured, and hand carried free of charge from your white friends in Russia to them folks in North Vietnam. How come you ain't mad at the Russians? 98 per cent of all the ammunition and all the equipment the North Vietnamese and the Viet Cong get to kill you with comes from the Russians, but you ain't mad at the Russians. Are you really that insane? That you know I'm paying somebody to attack your loved ones, your wife and your family, but you ain't mad at me, just mad at them and every day we go to dinner. See, we still bring the Russian Ballet to America. We still bring the Russian track team to America. What we're trying to say is we believe if 98 per cent of all the weapons and equipment the North Vietnamese and the Viet Cong was getting in the last five years

RE: APPEARANCE OF RICHARD CLAXTON GREGORY
AT WESTERN CAROLINA COLLEGE (WCC)
CULLOWHEE, NORTH CAROLINA

was coming from Ghana we believe this country would have declared war on Africa four years ago.

"We're talking about these inconsistencies. We're talking about the inconsistency of Muhammad Ali, I mean Cassius Clay. I forgot we can't remember Muhammad Ali. But if he had chose a good nigger name like Jabo Jones I bet you would have remembered that.

"Now we are talking about these inconsistencies. Muhammad Ali becomes heavyweight champ of the world. He lived in Louisville, Kentucky at the time. His boxing contract was owned by eleven white multi-millionaire businessmen in Louisville. One day Muhammad Ali received his induction notice from the Louisville draft board. Happily Muhammad Ali rushed down to the Louisville draft board. Happily they examined him and happily they found him to be 4-F. Nobody in America accused him of being unpatriotic. Nobody in America accused him of being disloyal. Nobody in America even questioned how the heavyweight champ of the world could be unfit to fight. One day Muhammad Ali's contract ended with the eleven white businessmen in Louisville. Instead of him renewing his contract with the white businessmen in Louisville, he signed a new contract with some black businessmen in Chicago. The Louisville draft board called him to come on back, they wanted to re-examine him. He went back. They re-examined him and this time they found him to be 1-A. I'm talking about your inconsistencies. As long as the white folks owned Muhammad Ali's contract he didn't have to get involved with the military, but the minute the black folks own it, it's a different ball game.

"We're tired of these inconsistencies. You know the biggest surprise I ever had in my life happened to me last summer. I went to Africa for the first time. I mean I went to Africa super-black. Had my natural _____ (unintelligible) and my dashiki was laying there, and I got with some young black dudes in Chicago and they taught me

RE: APPEARANCE OF RICHARD CLAXTON GREGORY
AT WESTERN CAROLINA COLLEGE (WCC)
CULLOWHEE, NORTH CAROLINA

the latest handshakes through the leg, around the back, the whole scene, you know. The biggest surprise I ever had, I eg all the way to Africa around black folks for the first time in my life, only to find out I ain't nothing but a white boy. And that ain't funny. That's a hell of a surprise. I don't have no black hang-ups. All my hang-ups are white. Get all the way to Africa to find out I ain't nothing but a chocolate-covered white boy. That's right. I ain't got no black hang-ups. All my hang-ups are white.

"You see in Africa they have no homosexuality. So consequently the men walk down the street holding one another's hands and I don't have to tell you what happened to me every time one of them men grabbed my hand. I sure hope the boys back home don't see this. No see, I had no black hang-ups. All my hang-ups are white. And I tell you something else you better not ever go to Africa and put your hand or your mouth on a woman's titty. No honest, ethical civilized human being would ever stoop to the level of using a woman's breast for anything else other than to feed nature's new life. Only sick, slimy, insane, degenerate creeps would ever stoop to the level of using a woman's breast as a sex hang-up. So I said this, I better get back home where all my hang-ups are legal.

"No, I say to you youngsters you got a big job. This is what black folks is talking about in America today. We're talking about controlling the black community. We ain't talking about controlling the white community, no, we're talking about controlling the black community. My God, what are we talking about that for? White folks start accusing us of being separatists. Well, we been separated in America for 400 years and all at once we're going to get blamed for separatism. Yeah, you got a lot of white folks in America just act like two years ago black folks and white folks were just living next door to one

RE: APPEARANCE OF RICHARD CLAXTON GREGORY
AT WESTERN CAROLINA COLLEGE (WCC)
CULLOWHEE, NORTH CAROLINA

another and going to school with one another. Two years ago we got mad at you, sad damn you whitey, and we all moved to a black ghetto by ourselves, right? We say to you folks that's concerned about separatism in America, since you're so concerned about separatism, how come you're not concerned about the Indian that's up there on that reservation? You can't get no more separate than that. Oh, that don't bother you. That's America doing it. If you want to get the Indian off the reservation in the morning, you'll get him off. Get that Indian off that reservation in the morning, you let that Indian hold a press conference tonight and get on television and say me like reservation. Don't want no more white folks on reservaion. You'd have an army up there about midnight and run him off.

"As long as you're doing it it's okay. Did you ever see a television show called the Dating Game? See that show? Every time a black contestant is on that show, the three guests just always happen to be black. That ain't racism. That don't bother nobody. That's the system. I tell you what would bother Americans. You let me go on that show next week and you find out that I refused to work that show because they had a white woman on and I want three black soul sisters. Oh, you never would hear the end of it.

"You know a black man can't drive a railroad train in America? That don't bother nobody. And as dumb as some white folks think niggers is, you don't need too much sense to drive a damn railroad train. All you got to do is follow the damn track. And as dumb as the railroad industry is, did you see last month where they lost 270 boxcars? How in the hell are you going to lose 270 boxcars? And then J. EDGAR HOOVER gets on television and announces we found them. Well that ain't no big thing. My little five-year-old daughter could have found them. All you got to do is show them the track they started on. Where in the hell are you going to take 270 boxcars, in your basement?

RE: APPEARANCE OF RICHARD CLAXTON GREGORY
AT WESTERN CAROLINA COLLEGE (WCC)
CULLOWHEE, NORTH CAROLINA

"We're talking about controlling the black community. That's right. We say give us black cops in the black community. Everybody says that's separatism. Call it what you want to call it. We call it being smart. Now you're going to say we know why you want black police in the black community, police brutality. Most of you white folks don't know what police brutality is as far as we are concerned. A lot of white folks think police brutality is the whooping. It can't be the whooping as far as we're concerned because up until recently the average black cops in the black ghetto was equally as brutal if not more brutal than the white cop was. And not only would the black cop whoop me, he knew where to hit. Yeah.

"You're running through the ghetto, a white cop jump out of his squad car and chase me and catch up with me and take his night stick and hit me across my head, would damn near break his stick every time. A black cop chases me and catch me and catch up with me, he'd beat down on my bare feet on my corns. That's right, that's the worst thing a nigger got his his feet. That's right. You white folks has had us walking on them for 400 years working. Niggers' feet so bad it's all back on his heels, all over on his ankles. You white folks, oh, ain't he cool, ain't he got rhythm.

"We say give us black cops in the black communities. At least when that black cop is knocking me down he ain't calling me no nigger while he's whooping me. Give me a black cop in my community and at least when he pulls my car over for a moving violation he do not refer to my wife as gal. I say give me a black cop in my community so when I'm driving down the street with my light-complected black sister, he don't take me through some changes like that white cop do thinking it's a white woman.

RE: APPEARANCE OF RICHARD CLAXTON GREGORY
AT WESTERN CAROLINA COLLEGE (WCC)
CULLOWHEE, NORTH CAROLINA

"Do you know how insulting that is? Especially to me. You have a black woman in the car and is light complected and that old white racist cop thinks it's a white woman, he got to take me through some changes. Pull over boy. For what? And this really insults me because this thoroughly convinces me when I was growing up in my little hometown you don't want no niggers fooling with no white woman. I ain't never had no white woman, don't never want one. If she's your hang-up, you can take her to the moon if you want to and get her the hell on out of my face.

"I'm so damn sick and tired of these insults. I'm really behaving nice, man. Sitting there with this black woman in my car and the white cop thinks it's a white woman. He's got to take me through all those insults just because his great great grandfather didn't have enough decency to keep his ass out of the slave tent. Yeah, just understand one thing. That's how we got this light, you know. There's a lot of white folks with the illusion that niggers got this light because we just rape you. But you know, that's how we got this light, right? Slave jumping on the master's wife, right? Yeah, come here Mrs. Ann. What y'all want Mr. Slave? You know. Again? Yeah.

"There's a whole lots of white folks in America with the madness and the illusion that every niggers wants to rape you. I had it happen to me last month coming out of my office in New York City. I come out of the J. C. Penney Building. I get on the elevator on the 40th floor by myself. Elevator stops at the 39th floor and an old white woman gets on, 90 years old, on crutches and a foot missing. She get on and see me and say Ahh. She tried to get off and I just held the door. I said lady, you've really got to be putting me on. I mean I heard of wishful thinking.

RE: APPEARANCE OF RICHARD CLAXTON GREGORY
AT WESTERN CAROLINA COLLEGE (WCC)
CULLOWHEE, NORTH CAROLINA

"We're talking about controlling the black community. It's very important to us. See, they been giving tests in the black ghetto across this country where they've been asking five-year-old black kids to draw pictures of themselves, and nine times out of ten them little kids draw an animal. It's a hell of a thing. A system so vicious that it warps a little child's mind to the extent that when you ask him to draw a picture of himself he draws an animal. We're talking about controlling that black community so one day you'll ask a little black kid to draw a picture of himself and the only reason that picture won't look like him will be because he can't draw. It's very important to us.

"Have you ever, I guess you have, you've seen a picture of Beulah haven't you? The picture of Aunt Jemima? Seen the picture of Uncle Ben? Listen to me good now, because then you'll understand why we talk about controlling the black community. If you don't know what I'm talking about, go to the supermarket and get you them three products with Beulah, Aunt Jemima, and Uncle Ben on it. You know, Uncle Ben got on a tuxedo and Uncle Ben got on a bow tie. You know Uncle Ben ain't fat. Do you think it's an accident you made my man look better than my two women? We watch you very closely in America, and we notice you ain't never used no fat, out-of-shape hillbilly white woman to advertise nothing for you. Why do you want to take them liberties with me? That's what we're talking about, baby.

"We're talking about controlling the black community. That might not be no hang-up to you white folks to go to your supermarket and buy some baby food, but it's a hell of a hang-up for us. Have you ever bought some baby food in a black ghetto? What picture is on our baby food? A white baby. What the hell are you selling, white babies or turnips?

RE: APPEARANCE OF RICHARD CLAXTON GREGORY
AT WESTERN CAROLINA COLLEGE (WCC)
CULLOWHEE, NORTH CAROLINA

"And so we say _____ (unintelligible), we haven't got time to explain our actions to white folks that misunderstand what we're doing. Stokely Carmichael and Rap Brown came through one day and said black is beautiful, and we all said black is beautiful. And white folks all across the country got all uptight. And you didn't even know what he was saying. You live way over in some old white racist, segregated neighborhood. You don't know nothing about us. Many white folks thought that we were talking about black was beautiful at the expense that white was ugly. We ain't got no hang-ups with your color. You're the one that's got the hang-up. You're the only man in the history of the world that fell in love with your skin. Only man walking around talking about I'm a white man. Everybody else says, Russian, I'm a Russian . . . (next few words unintelligible). I'm a white man. Fell in love with your skin and then denied me the pleasure to fall in love with mind.

"Everything black something's wrong with it. Black market, blackball you, angel food cake is always light, devils food cake is always dark.

"I say to you, we were not saying black was beautiful at the expense of saying white was ugly. It's unfortunate you white folks live so far away from us and don't know nothing about us. We were saying black was beautiful because up until five years ago even we was convinced that black was ugly. And we was running around with our lips all tucked in because you white folks said big lips was bad. Niggers running around hiding their nose. (Next few words unintelligible). Well, we mean black is beautiful, not at the expense of your whiteness. We mean black is beautiful. That's what nature gave us. And we ain't tucking in our lips no more. We're letting them all hang out.

RE: APPEARANCE OF RICHARD CLAXTON GREGORY
AT WESTERN CAROLINA COLLEGE (WCC)
CULLOWHEE, NORTH CAROLINA

"Niggers used to run around being ashamed of the way they talk. Yeah, most white folks don't know that because you don't know nothing about us. But we was ashamed of the way we talked. If you check my history of what happened to me when I got here, when the slaves came over here the first thing they did was clipped our tongues. Can you imagine if I clipped your tongue and clipped your husband's tongue and y'all have a baby, y'all can't talk around the baby, and who does the baby hear talking, me, right? That's right. So we learned how to talk listening to white folks.

"If you don't believe it, record a record of me and listen to me and I sound just like you. And go to Africa and see who I sound more like, Africans or you. I can hear them now, I don't know why you colored folks don't apply y'allself and learn how to speak the English language, like us white folks in America. Hell, I wish all you white folks in America could get on a jet plane and fly to London, England in the morning and then you'd realize you can't speak English neither. And the only difference between you and me is we know we can't talk and we know you can't talk. What the hell do we want to run around sounding like you for? You see some nigger running through the black ghetto talking about gosh, come on you's guys. You know, you listen to them colored talk and you just can't understand what they're saying. That's right. That ain't no lie. And we listen to you whites talk and we can't understand what you're saying. We don't make no big issue out of it because we feel you're doing the best you can.

"You know you white folks should just listen to yourselves talk. You see, we listen to you talk all the time. Get you a tape recorder and record your conversation and play it back and write it down and get your English dictionary and see how many words you used you can't find in the English dictionary. Listen to yourself talk. We

RE: APPEARANCE OF RICHARD CLAXTON GREGORY
AT WESTERN CAROLINA COLLEGE (WCC)
CULLOWHEE, NORTH CAROLINA

listen to you all the time. Jesus Christ, chucky, let's go get some nooky (phonetic). Some what? Now just what in the hell is nooky? My English speaking friend. I checked every English dictionary and I can't find no nooky but I know it exists cause the way you say it. Thirty-eight years old, been all around the world, I still don't know what nooky is. Just sounds like something I ain't never had, and don't never want. I'll just be happy with my wife and eight kids. Damn nooky, whatever it might be y'all.

"As I leave you youngsters tonight, I say to you you have a big job. I say you have a big job in America because America is worth saving at the expense of alienating your mother, your father, the President and even the Vice President. See, there's nothing really wrong with the U. S. Constitution that a little enforcement for everybody wouldn't straighten out. You youngsters got a lot of questions you have to ask and one important question is a simple question but an important question. And that question is, if democracy is as good as we tell you it is, then why in the hell are we running all over the world trying to ram it down people's throats with a gun? And from the day you young folks work to make this democracy work right, that's the day you can bring the guns home. Because you see anything good, you don't have to force on people. They will steal it.

"So as I leave you tonight I say to you you got a big job. And you young Americans got the all important job of giving sanity back to an insane nation and I beg you young folks in America to understand the answer to America's problems is not dynamite, not guns. If you think the way you deal with the mentally deranged is slipping to the mental hospital at pitch black midnight and blow it up and kill everybody in it and your sicker than them folks lying inside there in the bed. If you think the way you deal with cancer is kill the patient instead of work with the

RE: APPEARANCE OF RICHARD CLAXTON GREGORY
AT WESTERN CAROLINA COLLEGE (WCC)
CULLOWHEE, NORTH CAROLINA

germ, then we're all in trouble. And you youngsters' violence don't scare America. For every piece of dynamite you got, America has got a missile. For every gun you got she has got a tank. You know the one thing you have that scares the hell out of America and us old fools? It ain't your guns, your violence, it's your moral force. That's the one thing we can't match with you. That's what you won the great boycott with remember? Not dynamite. You stood in front of your supermarkets across this country for five years armed with nothing more than an honest ethical dignity and said please don't buy California grapes and you stood there so long and you looked so beautiful, we listened to you. And we stopped buying California grapes.

"You youngsters in America think you got enough force and violence after what happened at Kent University and Jackson, Mississippi and you was upset. Did you think you were strong enough to wipe out the National Guard with violence? No, but you young folks in America were strong enough to do away with the National Guard last year. If you young folks organized young people across this country and then said because of Kent University, because of Jackson, Mississippi, we're calling for a nationwide boycott of celebrating Christmas for two years, what do you think would have happened? Sears and Roebuck would have wiped out that National Guard for you.

"I say to you youngsters tonight in America if violence was the answer to problems, America would have solved the problems on the face of this earth thirty years ago. So as I leave you I say to you you got a big job.

"And I briefly say to you young white kids in America thank you for changing our civil rights movement into a human rights movement. Because of you young white kids in America, today for the first time we're talking about our Indian brother, and our Puerto Rican brother and our Mexican brother, and our Asian American brother.

RE: APPEARANCE OF RICHARD CLAXTON GREGORY
AT WESTERN CAROLINA COLLEGE (WCC)
CULLOWHEE, NORTH CAROLINA

"But to you fellows in the house, when you go to bed one night, but before you go to sleep, think about all the women out here in the peace movement with you. Understand this, ladies are not out here in the peace movement because they're worried about going to Vietnam. You know something, you know if all the women left the peace movement in the morning, we don't have a peace movement tomorrow night.

"And some way you fellows in America are going to have to say thanks to these ladies and there's no grander way for you young men to say thanks to these ladies than getting behind the women's liberation movement and seeing to it it becomes a reality.

"You got a big job. You ladies got a big job too. You got to really reorientate your whole thinking. You women got to understand that nature put you on the face of this earth as a human being first and a woman second. And damn it, you deserve all the rights and courtesies that we give our fellow human beings as human beings. You got a big job.

"And so as I leave you tonight, I say to you that I hope you youngsters stay as honest and as ethical and as morally sound as you are and there'll be no guarantee and not only will America be a fit place for all human beings, but the world will be a better place because you was here.

"Thank you. God bless you. May you have fun."

F B I

Date: 4/28/71

Transmit the following in _____
(Type in plaintext or code)

Via AIRTEL _____
(Priority)

To: Director, FBI ATTENTION:

From: SAC, CINCINNATI (157-1731) (C) CIVIL RIGHTS SECTION
 GENERAL INVEST. DIV.
Subject: APPEARANCE OF DICK DOMESTIC INTELLIGENCE DIV.
GREGORY AT MIAMI UNIVERSITY,
MIDDLETOWN, OHIO CAMPUS,
APRIL 23, 1971

- CR EL DIH CRA-64
- PA PE PF E
- EID Bomb Threats Racial Matters
- Klan Organization

Summary of Complaint:

Enclosed herewith are eight (8) copies of a self-explanatory LHM regarding captioned subject. Two copies of FD-376 are stapled to this LHM.

One copy of LHM was furnished to U. S. Secret Service, Cincinnati, Ohio.

Copy to 55/37/1010
by routing slip for
 info action
date 5-3-71
by WHA/ld
acc 80472 dcd

REC-79
157-19474-3

100-440423-609A
15 APR 30 1971

4 ENCLOSURE

ACTION: UACB:

- Bureau No further action being taken and
- Encs. 8) (RM) LHM enclosed Copy furnished to USA
- Cincinnati FD-376 (enclosure to LHM)
- LHM being submitted
- Report being submitted
- Preliminary investigation instituted
- Limited investigation instituted

[Handwritten signature]
RACIAL INT. SEC.

55 MAY 10 1971

Approved: _____ Sent _____ M Per _____
Special Agent in Charge

(Mount Clipping in Space Below)

- Mr. Tolson _____
- Mr. Sullivan _____
- Mr. Mohr _____
- Mr. Bishop _____
- Mr. Brennan _____
- Mr. Callahan _____
- Mr. Casper _____
- Mr. Conrad _____
- Mr. Dalby _____
- Mr. Felt _____
- Mr. Gale _____
- Mr. Rosen _____
- Mr. Tavel _____
- Mr. Walters _____
- Mr. S. Ais _____
- Tele. Room _____
- Miss Holmes _____
- Miss Gandy _____

b6
b7c

How to end Viet war

Dick Gregory offers tips to young people here

BY MICHAEL BLACKMAN
 Activist Dick Gregory, who's pledged not to eat another bite of food until the Vietnam war is history called on young people here last night to use their power, ethics and concern to bring back sanity to an insane nation.

"You have a big job to do and there's not much time left," the former comedian repeatedly emphasized to about 800 persons at the Xavier University Fieldhouse.

Gregory, who earlier in the day spoke at Kent State in an anniversary program honoring the four students killed there a year ago, was

brought to Cincinnati by the XU Afro-American Student Assn. and the Student Government.

THE SMALL, slim, 38-year-old black activist, employing mostly humor to reach his predominantly young audience, said in his two-hour and 20-minute talk that young people had the potential to effect drastic changes in America.

For instance, the war: "If you young people organized and decided you were not going to celebrate Christmas until it's over, you'd be surprised how quick that war would get over."

If President Nixon didn't end it under such a boycott, he said, then Sears Roebuck would. He also suggested young people might decide not to buy any more General Motors products until America is out of Vietnam—"hit the country where it hurts."

"THE WAR in Vietnam is in your hands," said Gregory, who April 24 at a peace rally in San Francisco vowed to subsist on a liquid diet until the war is over.

He said the "young folks" today were the most morally honest ever, and he hoped "you understand who you are and what you're all about."

"I hope you don't have to depend on the old folks to understand your actions." (Young people today, he said, are looked down upon by the older generation as were blacks in the early 1960s.)

GREGORY, gesturing generously throughout his impassioned talk, was met often with applause to his comments, which included:

• (About the Vice President) "I believe Agnew's putting everybody on—I don't believe it's humanly possible to be that dumb. You have to say one thing, he's consistent."

• (About the Army intelligence spying on civilians) "If you know anything about the Army, there is no intelligence. Who else would wear spit-shined sandals?"

• (About his bugged telephone) "First thing I did when I got to the airport was go to the phone and call my wife and read the alphabet to her backwards. Anytime I get ready to call my brother, he's already on the line—and he ain't even got a phone."

• (On the proper term—colored, black or Negro) "You can call me anything you want—it's just safer to call me black."

• (About making Lt. Galley a "national hero") "We just might be gone beyond the point of no return."

• (On the American system) "If democracy's as good as we say it is, then why do we go all over the world trying to ram it down people's throats with guns?"

Cincinnati Enquirer
Cincinnati, Ohio

6 Cincinnati Post
Times Star
Cincinnati, Ohio
The Citizens
Columbus, Ohio

Columbus Dispatch
Columbus, Ohio

Dayton Daily News
Dayton, Ohio

Journal Herald
Dayton, Ohio

Date: 5/4/71
 Edition: 7 Star Final
 Author: Michael Blackman
 Editor: W. Friedenberg
 Title: DICK GREGORY

Character: 157-1077
or 157-3749

Classification:
Submitting Office: CINCINNATI

Being Investigated

100-440423-A
~~157-194-11-A~~

NOT RECORDED
MAY 18 1971

*B-File
Subj*

56 MAY 21 1971



UNITED STATES DEPARTMENT OF JUSTICE
FEDERAL BUREAU OF INVESTIGATION

In Reply, Please Refer to
File No.

WASHINGTON, D.C. 20535
April 28, 1971

Director
United States Secret Service
Department of the Treasury
Washington, D. C. 20220

Dear Sir:

The information furnished herewith concerns an individual who is believed to be covered by the agreement between the FBI and Secret Service concerning Presidential protection, and to fall within the category or categories checked.

1. Has attempted or threatened bodily harm to any government official or employee, including foreign government officials residing in or planning an imminent visit to the U. S., because of his official status.
2. Has attempted or threatened to redress a grievance against any public official by other than legal means.
3. Because of background is potentially dangerous; or has been identified as member or participant in communist movement; or has been under active investigation as member of other group or organization inimical to U. S.
4. U. S. citizens or residents who defect from the U. S. to countries in the Soviet or Chinese Communist blocs and return.
5. Subversives, ultrarightists, racists and fascists who meet one or more of the following criteria:
 - (a) Evidence of emotional instability (including unstable residence and employment record) or irrational or suicidal behavior;
 - (b) Expressions of strong or violent anti-U. S. sentiment;
 - (c) Prior acts (including arrests or convictions) or conduct or statements indicating a propensity for violence and antipathy toward good order and government.
6. Individuals involved in illegal bombing or illegal bomb-making.

Photograph has been furnished enclosed is not available
 may be available through _____

Very truly yours,

John Edgar Hoover
Director

Special Agent in Charge (Enclosure(s) (1) (Registered Mail)
U. S. Secret Service, Cincinnati, Ohio

Enclosure(s)

(Upon removal of classified enclosures, if any, this transmittal form
becomes UNCLASSIFIED.)



UNITED STATES DEPARTMENT OF JUSTICE
FEDERAL BUREAU OF INVESTIGATION

In Reply, Please Refer to
File No.

Cincinnati, Ohio
April 28, 1971

RE: APPEARANCE OF DICK GREGORY
AT MIAMI UNIVERSITY, MIDDLETOWN,
OHIO CAMPUS, ON
APRIL 23, 1971.

Sgt. [REDACTED]

[REDACTED] advised that Dick Gregory spoke at Finkelman Auditorium on the evening of April 23, 1971, on the Middletown Campus of Miami University. His audience consisted of approximately 650 people, of which approximately 60% were black persons.

The speech lasted for approximately 2 hours and 10 minutes, during which Gregory talked of the plight of the Negro and poor whites in which he discussed his opposition to the war in Vietnam.

According to Sgt. [REDACTED] Gregory made no inflammatory statements during this speech and did not exhort his audience to any type of violent activities.

The Dick Gregory lecture was sponsored by the Black Student Action Association of the Miami University Middletown, Ohio Campus. The tickets to the lecture were free to students and the general public. There were no disturbances or demonstrations after the speech.

THIS DOCUMENT CONTAINS NEITHER RECOMMENDATIONS NOR CONCLUSIONS OF THE FBI. IT IS THE PROPERTY OF THE FBI AND IS LOANED TO YOUR AGENCY; IT AND ITS CONTENTS ARE NOT TO BE DISTRIBUTED OUTSIDE YOUR AGENCY.

100-440423-609X

15-1*-19494-3
ENCLOSURE

b6
b7c

- 1 - Lion
- 1 - Mr. D. Brennan
- 1 - [Redacted]
- 1 - Mr. C. E. Glass

b6
b7c

4/20/70

CODE

- 1 - Mr. F. B. Griffith
- 1 - Mr. H. W. Little

URGENT

TELETYPE

EXEMPTED FROM AUTOMATIC
DECLASSIFICATION
AUTHORITY DERIVED FROM:
FBI AUTOMATIC DECLASSIFICATION GUIDE
EXEMPTION CODE: 25X(1)
DATE 04-29-2015 By: J89J28T90

TO: SAC NEW YORK
CHICAGO
ATLANTA

FROM: DIRECTOR, FBI

AUSTRALIAN VIETNAM MORATORIUM CAMPAIGN, INTERNAL SECURITY -

MISCELLANEOUS.



MRS. NANCY RUBIN, WIFE OF JERRY RUBIN, MRS. CORETTA KING AND RICHARD CLAXTON GREGORY HAVE BEEN INVITED AND HAVE EITHER ACCEPTED OR ARE CONSIDERING ACCEPTANCE TO ATTEND AUSTRALIAN VIETNAM MORATORIUM CAMPAIGN, NO DATE OR PLACE OF CAMPAIGN MENTIONED. [Redacted] THEME OF AMERICAN DELEGATES

b3

TO FIFTH STOCKHOLM CONFERENCE WAS "IDEAL 'CORPORATE COMPLICITY' AND DAYS OF ACTION PLANNED IN THE U. S. BETWEEN TWENTY-ONE AND THIRTY, APRIL AGAINST COMPANIES WITH MILITARY CONTRACTS." [Redacted]

b3

URGED SIMILAR ACTION AGAINST SUBSIDIARY COMPANIES SUCH AS HONEYWELL COMPUTERS AND QANTAS AIRWAYS.

ORIGINAL FILED IN

b6
b7c
b7E

- 1 - 100-440423 (Gregory)
- 1 - 62-108052 (King)
- 1 - [Redacted]

100-440423-

NOT RECORDED
49 APR 22 1970

HVL:ser
(11)

DUPLICATE YELLOW COPY
WIRE TRANSMITTED

SEE NOTE PAGE TWO

55 APR 24 1970

TELETYPE TO SAC NEW YORK
RE: AUSTRALIAN VIETNAM MORATORIUM
CAMPAIGN

RECIPIENT OFFICES INSTRUCTED TO CONTACT ESTABLISHED SOURCES
ONLY TO DETERMINE IF RUBIN, KING AND GREGORY OR OTHERS WILL
ATTEND CAMPAIGN IN AUSTRALIA. ANY PERTINENT DATA DEVELOPED
SHOULD BE SUBMITTED PROMPTLY BY LHM.



(S)

b1
b3



Department of State

TELEGRAM

LIMITED OFFICIAL USE 1328

gm PAGE 01 SINGAPORE 1753 110906Z

22
ACTION EA 15

FBI

INFO OCT-01 NEA-13: SS-20 NSC-10: SCS-04: SCA-01 PPT-02: SY-03

L-04 CIAE-00 INR-08: NSAE-00 RSC-01 P-03: USIA-12: PRS-01 4-1

CU-05 RSR-01 7104 W

086659

P 110830Z SEP 70
FM AMEMBASSY SINGAPORE
TO SECSTATE WASHDC PRIORITY 4632
AMCONGEN BOMBAY PRIORITY
INFO AMEMBASSY CANBERRA PRIORITY

b6 per FBI
b7C

LIMITED OFFICIAL USE SINGAPORE 1753

SUBJ: DICK GREGORY

1. WE UNDERSTAND THAT SINGER DICK GREGORY AND HIS ASSOCIATE JAMES ROBERT MCGRAW PLAN TO TRAVEL FROM AFRICA TO BOMBAY AND TO CONNECT THERE WITH AL ITALIA FLIGHT 760 SEPT 13 FOR ONWARD TRAVEL THROUGH SINGAPORE TO AUSTRALIA.

2. AUSTRALIAN HIGH COMMISSIONER SEPT 11 ASKED US TO INFORM CONCERNED U.S. AUTHORITIES THAT AUSTRALIA WILL DENY GREGORY AND MCGRAW ENTRY WHETHER IN TRANSIT OR OTHER CAPACITY, AND THAT THEY WILL NOT RPT NOT BE ISSUED AUSTRALIAN VISAS IN SINGAPORE.

100-44042358
NOT RECORDED

15 SEP 14 1970

3. BOMBAY MAY WISH TO INFORM GREGORY AND MCGRAW OF THE SUBSTANCE PARA TWO.

REC-49

4. FYI: PERM SEC OF FON MIN TOLD US THAT IF THEIR TRAVEL DOCUMENTS ARE IN ORDER AND IF GOS SECURITY AUTHORITIES HAVE NO OBJECTION, IMMIGRATION WILL PROBABLY PERMIT GREGORY AND MCGRAW TO ENTER SINGAPORE AS ORDINARY TOURISTS VISITORS FOR 7-DAY STAY WITHOUT NEED OF VISAS. PERM SEC ADDED THAT GREGORY AND MCGRAW WOULD PROBABLY NOT BE PERMITTED TO EXTEND THEIR STAY AND WHAT SINGAPORE IS UNHAPPY ABOUT THE

b6 per FBI
b7C

54 OCT 12 1970

LIMITED OFFICIAL USE