

# FEDERAL BUREAU OF INVESTIGATION

REPORTING OFFICE <b>NEW ORLEANS</b>	OFFICE OF ORIGIN <b>NEW ORLEANS</b>	DATE <b>4/10/62</b>	INVESTIGATIVE PERIOD <b>3/13/62 - 4/6/62</b>
TITLE OF CASE <b>FREEDOM RIDE, 1961 ILLINOIS CENTRAL RAILROAD NEW ORLEANS, LOUISIANA TO JACKSON, MISSISSIPPI JUNE 25, 1961</b>		REPORT MADE BY <b>SA HUNTER E. HELGESON</b>	TYPED BY <b>bal</b>
		CHARACTER OF CASE  <b>RM - CR</b>	

### REFERENCE:

Report of SA HUNTER E. HELGESON dated 2/2/62 at New Orleans.

-C-

### ADMINISTRATIVE:

An additional copy of this report is designated for the New Orleans Office in the event the Bureau instructs that a copy be furnished to the United States Attorney, Jackson, Mississippi.

-A\*-

COVER PAGE

APPROVED <i>[Signature]</i>	SPECIAL AGENT IN CHARGE	DO NOT WRITE IN SPACES BELOW	
COPIES MADE:		157-387-1401	
④ - Bureau (157-387)		16 APR 1962	
2 - New Orleans (157-313)		REC-14	
DISSEMINATION RECORD OF ATTACHED REPORT		NOTA	
AGENCY: Dept. FBI		<i>[Large Redacted Area]</i>	
REQUEST RECD: REC'D - CIV RIGHTS			
DATE FWD: 4/13/62			
HOW FWD: 6-94 (b)			
BY: bal:ep			

UNITED STATES DEPARTMENT OF JUSTICE  
FEDERAL BUREAU OF INVESTIGATION

## Copy to:

Report of: SA HUNTER E. HELGESON  
Date: APRIL 10, 1962

Office: NEW ORLEANS

Field Office File No.: New Orleans 157-318

Bureau File No.: 157-387

Title: FREEDOM RIDE, 1961  
ILLINOIS CENTRAL RAILROAD  
NEW ORLEANS, LOUISIANA TO  
JACKSON, MISSISSIPPI, JUNE 25, 1961

Character: RACIAL MATTER - CIVIL RIGHTS

Synopsis: On 3/12/62, [redacted]  
entered plea of nolo contendere to Breach of Peace  
charge in Hinds County Court, Jackson, Miss. Sentenced  
to four months in jail, suspended and fined \$200.  
[redacted] released from Hinds County Jail,  
4/5/62 on expiration of sentence.b6  
b7C

-C-

## DETAILS:

## AT JACKSON, MISSISSIPPI:

On March 13, 1962, Captain [redacted]  
Jackson Police Department, advised that on March 12,  
1962, an attorney representing [redacted]  
[redacted], appeared in Hinds County Court, Jackson,  
Mississippi and withdrew a plea of Not Guilty to  
a Breach of the Peace charge which had been previously  
entered by his client. The attorney then entered a  
plea of Nolo Contendere to this charge on behalf of  
his client. [redacted] was adjudged guilty and sentenced  
to four months in jail, suspended, and fined \$200.00.  
The fine was paid.

NO 157-318

On April 6, 1962, [redacted]  
Hinds County Jail, advised that on April 5, 1962,  
[redacted] was released on expiration of  
sentence.

b6  
b7C

F B I

Date: 4/13/62

AIRTEL

Transmit the following in \_\_\_\_\_  
(Type in plain text or code)

Via AIRMAIL \_\_\_\_\_  
(Priority or Method of Mailing)

TO: DIRECTOR, FBI (157-387)  
FROM: SAC, JACKSONVILLE (157-250) (P.)  
RE: "FREEBUS"  
RACIAL MATTERS  
  
CORE  
RACIAL MATTERS

Re JK airtel to Bureau 2/26/62.

Records, Clerk's Office, Marion County Circuit Court, Ocala, Fla., as checked on 4/12/62, reflect Circuit Court Judge D. R. SMITH has not yet set date to review convictions of three Freedom Riders

*Miscellaneous*

[Redacted] and [Redacted]

b6  
b7C

Jacksonville will follow this matter closely, the Bureau will be advised of all future pertinent developments, and letterhead memo submitted concerning results of above review when known.

3-Bureau (RM)  
3-Jacksonville  
(1- 105-66)  
(1-105-82)

RHA-beh  
(6)

EX-116

REC-72

*157-387-1402*

13 APR 16 1962

C C Wick

Approved: \_\_\_\_\_

Sent \_\_\_\_\_ Per \_\_\_\_\_

Special Agent in Charge

102 53 APR 20 1962



UNITED STATES GOVERNMENT

# Memorandum

ALL INFORMATION CONTAINED  
HEREIN IS UNCLASSIFIED  
DATE 11-30-2009 BY 60324 UC BAW/SAB/MJS

TO : DIRECTOR, FBI

DATE: 4/17/62

FROM : SAC, NEW ORLEANS (157-386)

(P)

SUBJECT: FREEDOM RIDE, 1961  
Trailways Bus No. P224  
Los Angeles, California to  
Jackson, Mississippi  
September 9, 1961  
RM; CR  
OO: New Orleans

*Freedom Riders - Misc*

Remylet, 3/15/62.

On April 16, 1962, [redacted]  
[redacted] First Judicial District Court, Caddo Parish, Shreve-  
port, Louisiana, advised his files indicate no further court  
action has resulted with reference to charges against [redacted]  
[redacted] and [redacted]

This matter being followed and Bureau will be  
appropriately advised.

NEW ORLEANS DIVISION

AT SHREVEPORT, LOUISIANA

Will follow and report state charges against [redacted]  
and [redacted]

2 Bureau  
2 New Orleans

DC:gas  
(4)

APR 18 9 00 AM '62

REC'D CIV RIGHTS

U.S. DEPT. OF JUSTICE  
F. B. I.

APR 18 4 58 PM '62

DIVISION  
GENERAL INVESTIGATIVE  
RECEIVED

157-386-403

[Large redacted area]

69  
APR 23 1962

b6  
b7c

# FEDERAL BUREAU OF INVESTIGATION

REPORTING OFFICE <b>NEW ORLEANS</b>	OFFICE OF ORIGIN <b>NEW ORLEANS</b>	DATE <b>4/6/62</b>	INVESTIGATIVE PERIOD <b>10/12/61 - 3/22/62</b>
TITLE OF CASE  <b>FREEDOM RIDE, 1961 TRAILWAYS BUS TERMINAL JACKSON, MISSISSIPPI 11:00 PM, JULY 5, 1961</b>		REPORT MADE BY <b>SA HUNTER E. HELGESON</b>	TYPED BY <b>eah</b>
		CHARACTER OF CASE  <b>RM; CR</b>	

*At. Freedom Riders - Misc*

### REFERENCE

Report of SA HUNTER E. HELGESON, New Orleans, 9/21/61.

-C-

### ADMINISTRATIVE

An additional copy of this report is designated for the New Orleans Office in the event the Bureau instructs that a copy be furnished to the U. S. Attorney, Jackson.

-A\*-

### COVER PAGE

37  
EX-116  
PROC.

**157-387-1404**

APPROVED <i>H. M. [Signature]</i>	SPECIAL AGENT IN CHARGE	DO NOT WRITE IN SPACES BELOW	
COPIES MADE: <b>4 - BUREAU (44-17831) 2 - NEW ORLEANS (157-326)</b>		<b>44-1731-167</b>	REC-42 EX-116
DISSEMINATION RECORD OF ATTACHED REPORT		b6 b7C	
AGENCY <i>Dept.</i>	RECEIVED (DATE)	b6 b7C	
REQUEST RECD.	RECEIVED	b6 b7C	
DATE FWD. <i>4/11/62</i>		b6 b7C	
HOW FWD. <i>le-94 (b)</i>		b6 b7C	
BY <i>ehl: pp</i>		b6 b7C	

**U.S. DEPT. OF JUSTICE  
F. B. I.  
APR 15 2 15 PM '62**

**STATE DEPT.  
REC'D - CIA MICHLE**

*02 APR 9 1962*

UNITED STATES DEPARTMENT OF JUSTICE  
FEDERAL BUREAU OF INVESTIGATION

## Copy to:

Report of: SA HUNTER E. HELGESON Office: NEW ORLEANS  
Date: 4/6/62  
Field Office File No.: 157-326 Bureau File No.: 44-17831  
Title: FREEDOM RIDE, 1961  
TRAILWAYS BUS TERMINAL  
JACKSON, MISSISSIPPI  
11:00 PM, JULY 5, 1961  
Character: RACIAL MATTERS;  
CIVIL RIGHTS

## Synopsis:

Following individuals tried and convicted in Hinds County Court, Jackson, Miss., on Breach of Peace charges on dates indicated: [redacted] 10/11/61; [redacted] 10/17/61; [redacted] 10/23/61; [redacted] 1/8/62. All above sentenced to four months in jail and fined \$200. All released on appeal bond. On 3/22/62, [redacted] and [redacted] tried in Hinds County Court and released after court order directed verdict of acquittal.

b6  
b7c

- C -

DETAILS: AT JACKSON, MISSISSIPPI

On October 12, 1961, City Prosecuting Attorney J. A. TRAVIS, JR., City of Jackson, advised that on October 11, 1961, [redacted] was tried and convicted in Hinds County Court, Jackson, on a Breach of the Peace charge. He was sentenced the same date to four months in jail and fined \$200. He was released on October 11, 1961, on a \$1,000 cash appeal bond, plus a \$500 cash cost bond, both returnable in Hinds County Circuit Court, Jackson, Mississippi.

On October 17, 1961, City Prosecuting Attorney TRAVIS advised SA [redacted] that on October 17, 1961, [redacted] was tried in Hinds County Court, Jackson, on a charge of Breach of the Peace. [redacted] was convicted and sentenced the same date to four months in jail and fined \$200. [redacted] was released the same date on a \$1,000 cash appeal bond, plus a \$500 cash cost bond, returnable in Hinds County Circuit Court, Jackson, Mississippi.

NO 157-326

On October 23, 1961, [redacted] Hinds County Circuit Clerk's Office, advised SA [redacted] that on that date [redacted] was tried in Hinds County Court after entering a plea of not guilty to a charge of Breach of the Peace. [redacted] was tried and convicted and sentenced to four months in jail and fined \$200. He was released the same date on a \$1,000 cash appeal bond, plus a \$500 cash cost bond, returnable in Hinds County Circuit Court.

On January 8, 1962, Captain [redacted] Police Department, Jackson, Mississippi, advised that on that date [redacted] was tried and convicted in Hinds County Court, Jackson, on a Breach of the Peace charge. He was sentenced the same date to four months in jail and fined \$200. He was released the same date on a \$1,000 cash appeal bond, plus a \$500 cash cost bond, returnable in Hinds County Circuit Court.

On March 22, 1962, Captain [redacted] advised that on that date [redacted] and [redacted] were tried in Hinds County Court on charges of Breach of the Peace. Both were released after the court ordered a directed verdict of acquittal. b6 b7C

On January 29, 1962, Assistant City Prosecuting Attorney [redacted] City of Jackson, advised that due to the extremely heavy docket in Hinds County Court the court reporters are far behind in transcribing the records of Freedom Rider trials. Until these records are transcribed, the Hinds County Circuit Court cannot rule on the appeals to it from Hinds County Court in these cases. [redacted] stated there is no way of knowing when the Hinds County Circuit Court will handle these appeals, as this is a matter for the Court; however, he indicated that it would probably not be until at least late 1962.

# FEDERAL BUREAU OF INVESTIGATION

REPORTING OFFICE <b>NEW ORLEANS</b>	OFFICE OF ORIGIN <b>NEW ORLEANS</b>	DATE <b>4/9/62</b>	INVESTIGATIVE PERIOD <b>11/27/61 - 4/3/62</b>
TITLE OF CASE <b>FREEDOM RIDE <sup>Misc</sup> 1961 Greyhound Bus Los Angeles, California to Jackson, Mississippi July 15, 1961</b>		REPORT MADE BY <b>SA HUNTER E. HELGESON</b>	TYPED BY <b>lrs</b>
		CHARACTER OF CASE <b>RM; CR</b>	

REFERENCES:

Report of SA HUNTER E. HELGESON dated 9/26/61 at New Orleans.

- C -

ADMINISTRATIVE:

An additional copy of this report is designated for the New Orleans Office in the event the Bureau instructs that a copy be furnished to the United States Attorney, Jackson, Mississippi.

EXP. PROC.

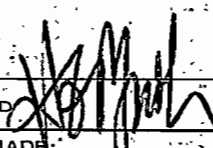
APPROVED 	SPECIAL AGENT IN CHARGE	DO NOT WRITE IN SPACES BELOW	
COPIES MADE: <b>4-Bureau (44-17831) 2-New Orleans (157-340)</b>		<b>44-17831-168</b>	REC-9
			57-104
			b6 b7C

*Am*  
**157-387-1405**

HEAD-COPIES

DISSEMINATION RECORD OF ATTACHED REPORT			
AGENCY	<i>dept</i>		
REQUEST RECD.			
DATE FWD.	<i>4/10/62</i>		
HOW FWD.	<i>R/S</i>		
BY	<i>RL:pp</i>		

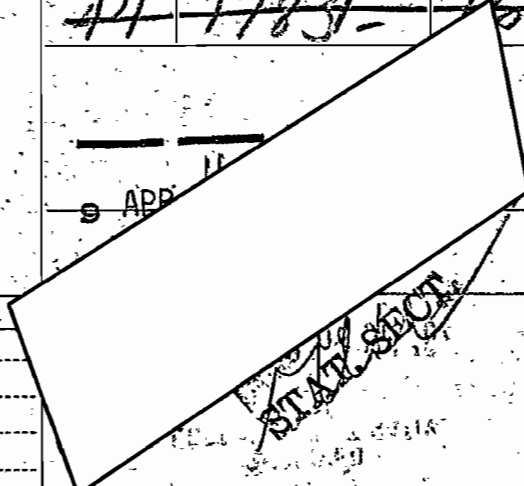

STAT. SECT.

*1 cc org unit  
3/13*

UNITED STATES DEPARTMENT OF JUSTICE  
FEDERAL BUREAU OF INVESTIGATION

Copy to:

Report of: SA HUNTER E. HELGESON  
Date: 4/9/62

Office: NEW ORLEANS

Field Office File No.: NEW ORLEANS (157-340)

Bureau File No.: (44-17831)

Title: FREEDOM RIDE, 1961  
Greyhound Bus  
Los Angeles, California to  
Jackson, Mississippi  
July 15, 1961b6  
b7c

Character: RACIAL MATTERS; CIVIL RIGHTS

Synopsis: The following individuals tried and convicted  
in Hinds Co. Court, Jackson, on breach of peace charges  
on dates indicated: [redacted] 12/13/61; [redacted][redacted] 1/25/62; [redacted] 3/12/62; [redacted]  
[redacted] 3/26/62; ROSE SCHORR ROSENBERG, 3/26/62;  
[redacted] 4/2/62. All above sentenced to 4  
months in jail and fined \$200. All released on appeal  
bond. The following individuals entered pleas of nolo  
contendere to breach of peace charges in Hinds Co. Court  
on dates indicated: [redacted] 11/27/61; [redacted][redacted] 1/12/62; [redacted] 3/12/62;  
[redacted] 3/12/62; [redacted]  
4/27/62. [redacted] appeared in Hinds Co. Court  
3/12/62 for trial but due to insufficient persons avail-  
able for jury duty, trial passed to end of docket and  
possibly will be passed to file.

- C -

DETAILS:AT JACKSON, MISSISSIPPI

On December 15, 1961, [redacted]  
[redacted] Hinds County Sheriff's Office, advised  
that on December 13, 1961, [redacted] was tried and con-  
victed in Hinds County Court on a charge of breach of  
the peace. He was sentenced the same date to four months  
in jail and fined \$200. He was released the same date  
on a \$1000 cash appeal bond plus a \$500 cash costs bond  
returnable in Hinds County Circuit Court.



NO 157-340

On January 29, 1962, Assistant City Prosecuting Attorney [redacted] City of Jackson, advised that on January 25, 1962, [redacted] was tried and convicted in Hinds County Court, Jackson, on a breach of the peace charge. He was sentenced the same date to four months in jail and fined \$200. He was released the same date on a \$1000 cash appeal bond plus a \$500 cash costs bond returnable in Hinds County Circuit Court.

On March 13, 1962, Captain [redacted] Jackson Police Department, advised that on March 12, 1962, [redacted] was tried and convicted in Hinds County Court, Jackson, on a charge of breach of the peace. She was sentenced the same date to four months in jail and fined \$200. She was released the same date on a \$1000 cash appeal bond plus a \$500 cash costs bond, returnable in Hinds County Circuit Court, Jackson.

b6  
b7c

On November 21, 1961, Captain [redacted] Jackson Police Department, advised that the trial date for [redacted] scheduled for November 28, 1961, had been postponed until January 23, 1962.

On January 8, 1962, Captain [redacted] advised that the trial of [redacted] had been again postponed until March 26, 1962.

On January 11, 1962, Attorney [redacted] advised that the trial of ROSE SCHORR ROSENBERG originally scheduled for December 11, 1961 in Hinds County Court had been postponed until March 26, 1962.

On March 26, 1962, Captain [redacted] Jackson Police Department, advised that on March 26, 1962, [redacted] and ROSE SCHORR ROSENBERG were tried and convicted in Hinds County Court, Jackson, Mississippi, on a charge of breach of the peace. Both were sentenced the same date to four months in jail and fined \$200. Both were released the same date on \$1000 cash appeal bonds each, plus \$500 cash costs bonds each, returnable in Hinds County Circuit Court, Jackson, Mississippi.

On April 3, 1962, Captain [redacted] advised that on April 2, 1962, [redacted] was tried and convicted in Hinds County Court, Jackson, on a charge of breach of the peace. He was sentenced the same date to four months in jail

NO 157-340

and fined \$200. He was released the same date on a \$1000 cash appeal bond plus a \$500 cash costs bond returnable in Hinds County Circuit Court.

On January 29, 1962, Assistant City Prosecuting Attorney [redacted], City of Jackson, advised that due to the extremely heavy docket in Hinds County Court, the Court Reporters are far behind in transcribing the records of Freedom Rider Trials. Until these records are transcribed, the Hinds County Circuit Court cannot rule on the appeals to it from Hinds County Court in these cases. [redacted] stated there is no way of knowing when the Hinds County Circuit Court will handle these appeals as this is a matter for the court; however, he indicated that it would probably not be until at least late 1962.

On November 27, 1961, Captain [redacted] Police Department, advised that on November 27, 1961, Attorney [redacted] representing [redacted] appeared in Hinds County Court and withdrew a previously entered not guilty plea to a breach of the peace charge. He entered a plea of nolo contendere to this charge on [redacted] behalf. [redacted] was not present in court. On the same date, [redacted] was adjudged guilty and sentenced to four months in jail, suspended, and fined \$200. [redacted] paid the fine in behalf of his client.

On January 15, 1962, Captain [redacted] Police Department, advised that on January 12, 1962, Attorney [redacted] appeared in Hinds County Court representing [redacted] [redacted] withdrew a previously entered plea of not guilty by his client to a breach of the peace charge and entered a plea of nolo contendere to this charge. [redacted] was adjudged guilty and sentenced to four months in jail, suspended, and fined \$200. The fine was paid by [redacted]

On March 13, 1962, Captain [redacted] Police Department, advised that on March 12, 1962, an attorney representing [redacted] and [redacted] appeared in Hinds County Court and withdrew pleas of not guilty to breach of the peace charges which had previously been entered by his clients. The attorney then entered pleas of nolo contendere to these charges on behalf of his



NO 157-340

clients. Both [redacted] and [redacted] were adjudged guilty and each was sentenced to four months in jail, suspended, and each fined \$200. The fine was paid by the attorney.

On April 3, 1962, Captain [redacted] Police Department, advised that on April 2, 1962, an attorney representing [redacted] appeared in Hinds County Court and withdrew a plea of not guilty to a breach of the peace charge which had been previously entered by his client. The attorney entered a plea of nolo contendere to this charge on behalf of his client. [redacted] was adjudged guilty and sentenced to four months in jail, suspended, and fined \$200. The attorney paid the fine.

b6  
b7C

On March 13, 1962, Captain [redacted] Police Department, advised that [redacted] appeared in Hinds County Court on March 12, 1962 for trial on a charge of breach of the peace. Inasmuch as there were insufficient persons available to serve as jurors at his trial, his case was passed to the end of the docket. [redacted] advised that because [redacted] had traveled from Seattle, Washington, to Jackson for the trial, it was very probably that his case would be passed to the file and no further action would be taken to try [redacted] on these charges.

Mr. Tolson	_____
Mr. Belmont	_____
Mr. Mohr	_____
Mr. Callahan	_____
Mr. Conrad	_____
Mr. DeLoach	_____
Mr. Evans	_____
Mr. Malone	_____
Mr. Rosen	_____
Mr. Sullivan	_____
Mr. Tavel	_____
Mr. Trotter	_____
Tele. Room	_____
Miss Holmes	_____
Miss Gandy	_____

F B I

Date: 4/18/62

Transmit the following in PLAIN TEXT  
(Type in plain text or code)

Via AIRTEL AIRMAIL  
(Priority or Method of Mailing)

TO: DIRECTOR, FBI (157-387)

FROM: SAC, NEW ORLEANS (157-264)

SUBJECT: FREEBUS *FREEBON RIDERS - MISCELLANEA*

On 4/17/62, Captain [redacted] Police Department, Jackson, Miss., furnished the following information:

On the dates indicated the following individuals were tried and convicted in Hinds County Court, Jackson on a charge of Breach of the Peace. All were sentenced the same date to four months in jail and fined \$200.00. All were released the same date on appeal bond.

b6  
b7c

*MISS.*

[redacted]	4/10/62
[redacted]	4/10/62
[redacted]	4/11/62
[redacted]	4/11/62
[redacted]	4/12/62
[redacted]	4/12/62
[redacted]	, 4/16/62
[redacted]	4/16/62

On the dates indicated the following individuals entered pleas of nolo contendere to Breach of the Peace charges in Hinds County Court and were sentenced the same date to four months in jail, suspended and fined \$200.00, paid:

3-Bureau  
2-New Orleans

HEH: mh  
(5)

*REC-1A* 157-387-1406

8 APR 24 1962

*EX-114*

*REC-62*

*ST-115*

*6-705*

*Wick*  
Approved: *[Signature]* 4/18/62  
Special Agent in Charge

Sent \_\_\_\_\_ M Per \_\_\_\_\_

[REDACTED]	4/9/62
[REDACTED]	4/9/62
[REDACTED]	4/16/62
[REDACTED]	"
[REDACTED]	"
[REDACTED]	"
[REDACTED]	"
[REDACTED]	"
[REDACTED]	"

*MISS*

b6  
b7c

In reference to New Orleans airtel to Bureau, 4/10/62, concerning the dismissal of charges against the fifteen Episcopal clergymen arrested as Freedom Riders, Capt. [REDACTED] advised on 4/17/62 that there subsequently was local publicity concerning the dismissal of these charges and that some of these clergymen appeared in Jackson protesting that if charges against them were dropped then charges against other Freedom Riders arrested should be dropped. As a result of this Hinds County Judge RUSSELL MOORE, who had not at that time signed the order of dismissal, directed that the clergymen should appear and stand trial as originally scheduled.

Tolson ✓  
 Belmont ✓  
 Mohr \_\_\_\_\_  
 Callahan \_\_\_\_\_  
 Conrad \_\_\_\_\_  
 DeLoach \_\_\_\_\_  
 Evans \_\_\_\_\_  
 Malone ✓  
 Rosen ✓  
 Sullivan \_\_\_\_\_  
 Tavel \_\_\_\_\_  
 Trotter \_\_\_\_\_  
 Tele Room \_\_\_\_\_  
 Holmes \_\_\_\_\_

# Judge Switches Ruling, Ministers to Be Tried

JACKSON, Miss., April 11 (AP).—A racially mixed group of Episcopal clergymen confronted authorities yesterday to protest for "clerical immunity" and found out they would be prosecuted for desegregation activities.

The nine ministers—including the Rev. Robert L. Pierson of New York City, son-in-law of New York Gov. Nelson Rockefeller—sought immunity from breach of peace prosecution for all "Freedom Riders."

County Judge Russel Moore, who a day earlier had dropped charges against the 15 ministers, rescinded the action yesterday. They were arrested at the Trailways Bus Terminal September 13, 1961.

The clergymen, seeking to speak to Judge Moore about immunity from prosecution, didn't know of his adverse ruling.

### Conference Set Up

When faced by the ministers following a court's session, Judge Moore turned and walked out. An aide set up a conference for today.

Judge Moore said there was some misunderstanding about the earlier ruling. "It was unofficial and the change was made in order to uphold the integrity of the court," he said.

The special prosecuting attorney, Jack Travis, jr., had asked that charges be dropped for technicalities and out of

respect and admiration for the Episcopal Church.

After a two-hour wait in the foyer of City Hall yesterday the ministers confronted Mr. Travis and asked for an explanation on the change. He explained his position privately, but refused official comment. He said he planned prosecution as scheduled, in May.

### "Capricious Justice"

The group spokesman, the Rev. John Morris of Atlanta, Ga., said the action showed the "capricious nature of Mississippi justice." They had no other comment.

Shortly after Mr. Travis issued his statement of clerical immunity Monday, Judge Morris said prosecutors should dismiss charges against all Freedom Riders if they wanted to be consistent in court.

The ministers include four who were not arrested last fall, but all were among the 28 in the "prayer pilgrimage" from New Orleans, La., to Detroit, Mich.

Others in the group are the Revs. Layton Zimmer of Swarthmore, Pa.; Malcolm Boyd of Detroit; Robert Fortna of New York; Robert Taylor of Chicago; Quinlan Gordon of Washington; James Breeden of Boston and Robert Chapman of New York. The latter three are Negroes.

b6  
b7c

*Freedom Riders*

*6-PM*

*File FREEBUS*

The Washington Post and Times Herald \_\_\_\_\_  
 The Washington Daily News \_\_\_\_\_  
 The Evening Star *AS* \_\_\_\_\_  
 New York Herald Tribune \_\_\_\_\_  
 New York Journal-American \_\_\_\_\_  
 New York Mirror \_\_\_\_\_  
 New York Daily News \_\_\_\_\_  
 New York Post \_\_\_\_\_  
 The New York Times \_\_\_\_\_  
 The Worker \_\_\_\_\_  
 The New Leader *2044* \_\_\_\_\_  
 The Wall Street Journal \_\_\_\_\_  
 The National Observer \_\_\_\_\_  
 Date \_\_\_\_\_

*157 387-19*

NOT RECORDED  
100 APR 20 1962

*10 30 1962*

APR 11 1962

60 APR 23 1962

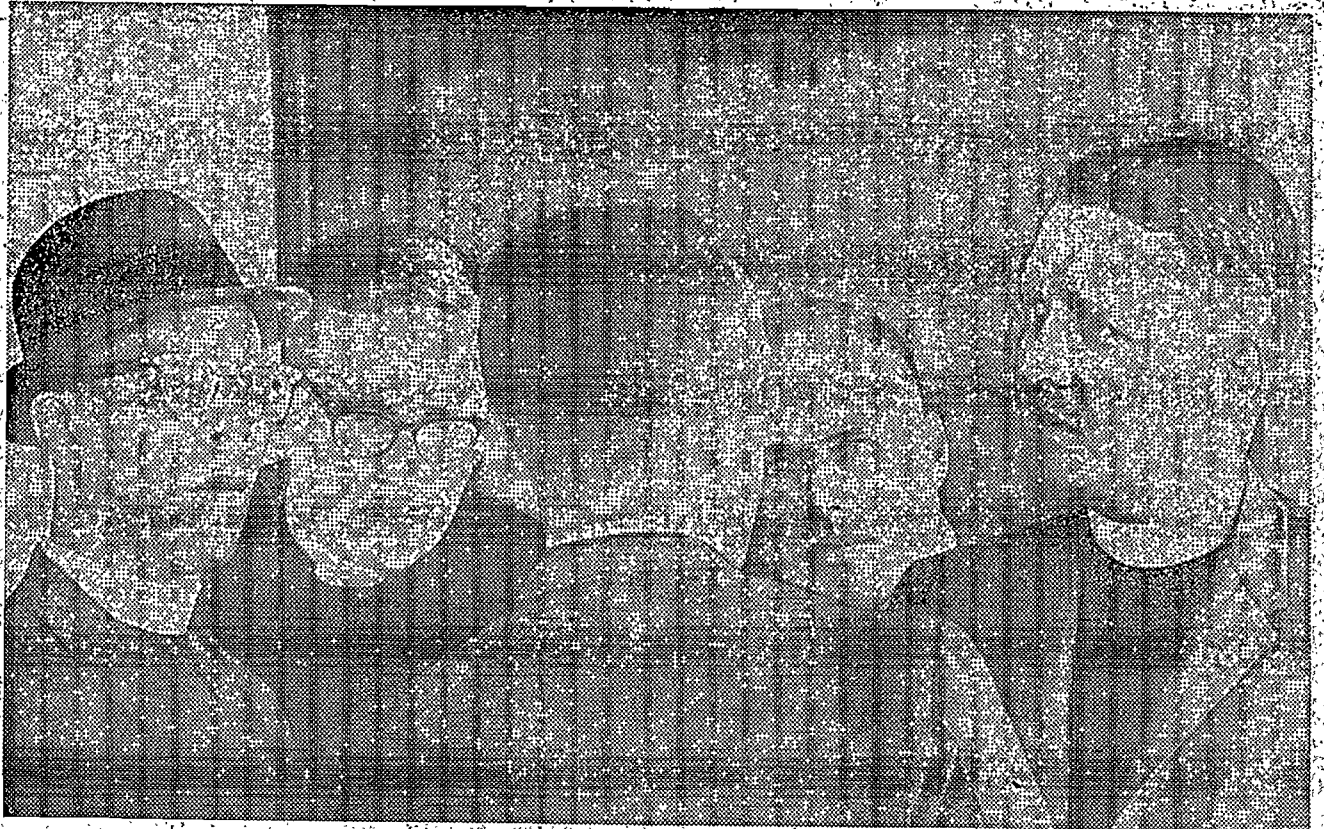

Episcopal ministers confer with Tom Gaither, (back to camera) president of the Jackson (Miss.) Congress of Racial Equality, after learning they will be prosecuted for breach of peace at Jackson. The ministers (left to right) are:

The Revs. Quinland Gordon of Washington, Layton Zimmer of Swarthmore, Pa., Malcolm Boyd of Detroit and John Morris of Atlanta.— AP Wirephoto.



NO 157-363

NEW ORLEANS DIVISION:

AT SHREVEPORT, LOUISIANA:

Will follow and report disposition of charges in  
State Court.

B\*  
COVER PAGE



UNITED STATES DEPARTMENT OF JUSTICE  
FEDERAL BUREAU OF INVESTIGATION

## Copy to:

Report of: SA [REDACTED]  
Date: April 25, 1962

Office: NEW ORLEANS

Field Office File No.: NO 157-363

Bureau File No.: 44-17831

Title: FREEDOM RIDE, 1961; TRAILWAYS BUS  
SHREVEPORT, LOUISIANA TO JACKSON, MISSISSIPPI  
AUGUST 4, 1961

Character: RACIAL MATTERS; CIVIL RIGHTS

b6  
b7c

Synopsis: Docket of First Judicial District Court, Caddo Parish, Shreveport, La., reflects no further action in instant case since 90 day stay of execution of sentence granted 11/21/61. District Attorney, Caddo Parish, advised case presently pending and no action taken upon expiration of 90 day stay of execution in view of information that petition for writ of certiorari was filed on behalf of defendants in 3/62 with U. S. Supreme Court.

- P -

DETAILS:AT SHREVEPORT, LOUISIANA:

On April 18, 1962, [REDACTED] First Judicial District Court, Caddo Parish, advised the docket in instant case reflects no further action since November 21, 1961 when a ninety-day stay of execution of sentence was granted by Judge ROBERT J. O'NEAL.

On April 18, 1962, District Attorney [REDACTED] Caddo Parish, advised the case is presently pending, and that no action had been taken by him upon the expiration of the ninety-day-stay of execution in view of information furnished him by the Attorney General's Office, State of Louisiana, New Orleans, Louisiana, indicating that a petition for writ of certiorari had been filed on behalf of the defendants by several New York attorneys with the United States Supreme Court sometime in



NO 157-363

March, 1962. He stated he has not been advised whether the writ of certiorari has been granted or denied as yet.

On April 18, 1962 review of the Identification Records, Caddo Parish Sheriff's Office, as made available by Capt. [redacted] [redacted] reflected that [redacted] had been released on \$750.00 bond on February 5, 1962. L2

On April 19, 1962 District Attorney JOHN RICHARDSON, Caddo Parish, Shreveport, Louisiana, advised he had received a telegram on that date from Attorney General, State of Louisiana, New Orleans, advising that the United States Supreme Court had requested that he file an opposition to the application for writ of certiorari filed by the defense on March 10, 1962 with the United States Supreme Court. [redacted] stated it will require about twenty-five to thirty days to prepare and file this opposition. b6  
b7c

F B I

Date: 4/28/62

Transmit the following in \_\_\_\_\_  
(Type in plain text or code)

Via AIRTEL AIRMAIL - REGISTERED  
(Priority or Method of Mailing)

TO: DIRECTOR, FBI (157-387)  
FROM: SAC, BIRMINGHAM (157-85) C

FREEBUS

encl. Re New Orleans airtel to Bureau, 3/16/62.

Transmitted herewith are eight copies of letter-  
head memorandum in captioned matter.

CIC, ONI, and OSI, Birmingham have been furnished  
copies of this memorandum.

Wick

ICC  
Agency G-2, ONI, OSI, ORD

Date Forw. 5/2/62

How Forw. R/S

By RBL:pp  
1 cc org. unit  
\* cc destroyed

3- Bureau (AM-RM) (Enc. 8)  
2- Birmingham  
CBS:pp  
(5)

ENCLOSURE

242

EX-115

REC-10

157-387-1408

4 MAY 1 1962

Approved: \_\_\_\_\_  
Special Agent in Charge

Sent \_\_\_\_\_ M Per \_\_\_\_\_



In Reply, Please Refer to  
File No. ;57-85

UNITED STATES DEPARTMENT OF JUSTICE

FEDERAL BUREAU OF INVESTIGATION

300 American Life Building  
Birmingham, Alabama  
April 28, 1962

RE: FREEDOM RIDERS  
RACIAL MATTERS  
BIRMINGHAM DIVISION

On April 12, 1962, FRANK WEEKS, Chief of Police and [redacted] Winfield, Alabama, advised that after the operator of the Rebel Cafe at the Winfield Bus Station was forced by the Interstate Commerce Commission to serve colored and white patrons of the bus line, he closed his cafe. They advised that the bus station no longer has a rest stop at Winfield, Alabama and tickets are purchased at the American Gas Service Station in Winfield from [redacted].

b6  
b7c

They further advised that buses no longer stop in Winfield except to release and take on passengers and accordingly Negroes would no longer have a logical place to "retest" bus cafe facilities unless they tried to eat in one of the town's restaurants.

This memorandum is loaned is loaned to you by the FBI, and neither it nor its contents are to be distributed outside the agency to which loaned.

ENCLOSURE

157-387-1408

ALL INFORMATION CONTAINED  
HEREIN IS UNCLASSIFIED  
DATE 11-17-2009 BY 60324 UC BAW/SAB/MJS

F B I

Date: 5/2/62

Transmit the following in PLAIN TEXT  
(Type in plain text or code)

Via AIRTEL AIRMAIL  
(Priority or Method of Mailing)

TO: DIRECTOR, FBI (~~157-387~~)  
FROM: SAC, NEW ORLEANS (157-264) (P)  
RE: FREEBUS Freedom Riders Misc

On 4/30/62 Capt. [redacted] PD, Jackson, Miss.,  
furnished following information:

On dates indicated, following individuals were tried  
and convicted in Hinds County Court, Jackson, on Breach of the  
Peace charges: All were sentenced same date to four months in  
jail and fined \$200.00. All were released same date on appeal  
bond.

*Miss* { [redacted] 4/24/62  
[redacted] 4/24/62 b6  
[redacted] 4/30/62. b7C

On dates indicated, the following individuals were  
tried in Hinds County Court on Breach of the Peace charges and  
released on directed verdicts of acquittal:

*Miss* { [redacted] 4/24/62  
[redacted] 4/30/62

On 4/30/62 following individuals entered pleas of  
nolo contendere to Breach of the Peace charges. All were  
sentenced same date to four months in jail, suspended, and  
fined \$200.00, paid:

*Miss* { [redacted]  
[redacted]  
[redacted]  
[redacted]

3 - Bureau  
2 - New Orleans  
HEH:pab  
(5)

EC-41

157-387-1409

13 MAY 4 1962

EX-113

[Handwritten signature]

Approved: 348 Sent \_\_\_\_\_ M Per \_\_\_\_\_

Special Agent in Charge

51 MAY 11 1962

UNITED STATES GOVERNMENT

# Memorandum

TO : DIRECTOR, FBI (157-387)

DATE: 5/7/62

FROM : SAC, MOBILE (157-52) (RUC)

SUBJECT: FREEBUS

*FREEBUS RIDERS - ALA.*

Re New Orleans airtel to Bureau and other offices  
3/27/62.

Information concerning the possibility of re-testing bus facilities at Dothan, Ala., and Montgomery, Ala., was furnished to the following officers on the dates indicated:

[redacted] NA, Detective Lt.,  
Dothan Police Department - 4/10/62

Sheriff [redacted] Houston County,  
Dothan, Ala., - 4/12/62

b6  
b7c

Assistant Chief [redacted] NA,  
Montgomery Police Department - 4/17/62

Lt. [redacted] NA, Department of  
Public Safety, Montgomery, Ala., - 4/17/62.

- (2) - Bureau (RM)
  - 2 - New Orleans (RM) (157-264)
  - 1 - Mobile
- JTB:leh  
(5)

U.S. DEPT. OF JUSTICE

REC-154

157-387-1410

MAY 11 8 23 AM '62

MAY 9 1962

RECEIVED  
GENERAL INVESTIGATIVE  
DIVISION

50 MAY 15 1962

UNITED STATES GOVERNMENT

# Memorandum

TO : DIRECTOR, FBI (44-17831)

DATE: 5/7/62

FROM : SAC, WFO (157-133) (P\*)

SUBJECT: RIDERS  
FREEDOM RIDE, 1961  
TRAILWAYS BUS,  
SHREVEPORT, LOUISIANA TO  
JACKSON, MISSISSIPPI  
8/4/61  
(OO:NO)

Re report of SA [redacted] New Orleans,  
dated 4/25/62.

Examination of the docket in the Clerk's Office,  
U. S. Supreme Court (USSC), on 5/3/62, disclosed that  
on 3/6/62, a petition for Writ of Certiorari and record were  
filed in the USSC. In the case entitled [redacted]  
[redacted] Case Number 773  
Appellate, October Term, 1961.

On 4/11/62, the petitioner's brief was distributed  
to the Court Justices.

b6  
b7C

Copy of the petitioner's brief was made available  
by [redacted] and the same is transmitted herewith for the  
information of the Bureau.

The Bureau is requested to return this brief to WFO  
when it has served its purpose and thereafter it will be  
returned to the USSC.

WFO will continue to follow this case in the USSC and  
will report disposition thereof.

- 2 - Bureau (Enc. 1)
- 1 - New Orleans (157-363)
- 1 - WFO

RCV:wcej  
(4)

REC-34  
157-387-140

ST-113

5 MAY 1962

ENCLOSURE

Enc. to WFO, 5/14/62

62 MAY 15 1962

F B I

Date: 5/7/62

Transmit the following in PLAIN TEXT  
(Type in plain text or code)

Via AIRTEL AIRMAIL  
(Priority or Method of Mailing)

TO: DIRECTOR, FBI (157-387)  
FROM: SAC, NEW ORLEANS (157-264) (P)  
RE: FREEBUS

On 5/3/62 Capt. [redacted] PD, Jackson, Miss.,  
furnished following info:

b6  
b7c

On 5/1/62 [redacted] and LULA MAE  
[redacted] were tried and convicted in Hinds/County Court, Jackson,  
on charges Breach of the Peace. Both were sentenced same date  
four months in jail and fined \$200.00. Both released same date  
on appeal bonds.

On 5/1/62 [redacted] was tried in Hinds  
County Court, Jackson, on Breach of the Peace charge. He was  
released on directed verdict of acquittal.

Capt. [redacted] advised there are no further Freedom Rider  
trials scheduled until 5/21/62 when trials of fifteen Episcopal  
clergymen commence. These trials will end 6/1/62.

UACB, the New Orleans Office will not submit further  
weekly airtel until 6/1/62 when results of trials of Episcopal  
clergymen will be submitted.

- 3 - Bureau
- 2 - New Orleans

HEH:pab

(5)

REC-15

157-387-1412

5 MAY 19 1962

50 MAY 15 1962

EX-114

U.S. DEPT. OF JUSTICE  
F. B. I.

G. C. Wick

MAY 8 10 50 AM '62

[Handwritten signature]

Approved: \_\_\_\_\_ Sent \_\_\_\_\_ M Per \_\_\_\_\_

Special Agent in Charge

F B I

Date: 5/8/62

Transmit the following in \_\_\_\_\_  
(Type in plain text or code)

Via A I R T E L A I R M A I L  
(Priority or Method of Mailing)

TO: DIRECTOR, FBI (157-387)

FROM: SAC, JACKSONVILLE (157-250) (P)

SUBJECT: "FREEBUS" *Freedom Riders - miscellaneous*  
RM

Re Jacksonville airtel to Bureau, dated 4/13/62.

*mj*  
Records, Clerk's Office, Marion County Circuit Court, Ocala, Fla., as checked on 5/7/62, reflect State Attorney [redacted] on 5/2/62, filed motion to dismiss appeals of convictions of three Freedom Riders [redacted] and [redacted]

b6  
b7c

On 5/2/62, Circuit Court Judge D. R. SMITH set 6/4/62, as date for hearing of arguments on above motion.

Jacksonville will follow this matter closely, the Bureau will be advised of all future pertinent developments, and letterhead memo submitted concerning results of above hearing when known.

*K*

*cc [unclear]*

REC-48

- 3 - Bureau (RM)
- 4 - Jacksonville
  - (1 - 105-66)
  - (1 - 105-82)

RHA-cec  
(7)

*157-387-1413*

DEPARTMENT OF JUSTICE

MAY 10 1962

MAY 10 1962

Approved: *[Signature]*  
Special Agent in Charge

Sent \_\_\_\_\_ M Per \_\_\_\_\_

62 MAY 18 1962



# FEDERAL BUREAU OF INVESTIGATION

REPORTING OFFICE <b>NEW ORLEANS</b>	OFFICE OF ORIGIN <b>NEW ORLEANS</b>	DATE <b>5/11/62</b>	INVESTIGATIVE PERIOD <b>4/17 - 24/62</b>
TITLE OF CASE <b>FREEDOM RIDERS, 1961 Trailways Bus New Orleans, Louisiana to Jackson, Mississippi 8/13/61</b>		REPORT MADE BY <b>HUNTER E. HELGESON</b>	TYPED BY <b>lil</b>
		CHARACTER OF CASE <b>RM; CR</b>	

REFERENCE:

Report of SA HUNTER E. HELGESON, dated 10/4/61, at New Orleans.

- C -

ADMINISTRATIVE:

An additional copy of this report is designated for the New Orleans Office in the event the Bureau instructs that a copy be furnished to the USA, Jackson, Miss.

U.S. GOVERNMENT PRINTING OFFICE: 1961 O 548-000

b6  
b7c

APPROVED <i>[Signature]</i>	SPECIAL AGENT IN CHARGE	DO NOT WRITE
COPIES MADE: ④ - Bureau (157-387) 2 - New Orleans (157-367)		157-387-3
		18 MAY
		REC-26
		EX-131
DISSEMINATION RECORD OF ATTACHED REPORT		NOTATIONS
AGENCY	REQUEST RECD.	DATE FWD.
BY		

*[Large diagonal redaction box]*

*[Stamps: POLICE, STATE SECT., RECEIVED]*

UNITED STATES DEPARTMENT OF JUSTICE  
FEDERAL BUREAU OF INVESTIGATION

Copy to:

Report of: HUNTER E. HELGESON  
Date: 5/11/62

Office: NEW ORLEANS

Field Office File No.: NO 157-367

Bureau File No.: 157-387

Title: FREEDOM RIDE, 1961  
Trailways Bus  
New Orleans, Louisiana to  
Jackson, Mississippi  
August 13, 1961Character: RACIAL MATTERS;  
CIVIL RIGHTS

Synopsis:

On 4/16/62 [redacted] entered plea of nolo contendere to breach of the peace charge in Hinds County Court, Jackson. Sentenced to four months in jail, suspended, and fined \$200, paid. On 4/23/62 [redacted] failed to appear in Hinds County Court for trial on breach of the peace charge as scheduled. Court ordered her bond forfeited.

b6  
b7c

- C -

DETAILS:AT JACKSON, MISSISSIPPI

On April 17, 1962, Captain [redacted] Jackson Police Department, advised that on April 16, 1962, an attorney representing [redacted], appeared in Hinds County Court, Jackson, and withdrew a plea of not guilty to a charge of breach of the peace which had previously been entered by his client. The attorney entered a plea of nolo contendere to this charge on [redacted] behalf. On the same date, [redacted] was adjudged guilty and sentenced to four months in jail, suspended, and fined \$200 which was paid by the attorney.

NO 157-367

On April 24, 1962, Captain [redacted] advised that on April 23, 1962, [redacted] failed to appear in Hinds County Court, Jackson, for trial on breach of the peace charges as scheduled. The court ordered her \$500 bond forfeited.

b6  
b7c

# FEDERAL BUREAU OF INVESTIGATION

REPORTING OFFICE <b>NEW ORLEANS</b>	OFFICE OF ORIGIN <b>NEW ORLEANS</b>	DATE <b>5/11/62</b>	INVESTIGATIVE PERIOD <b>12/26/61 - 4/24/62</b>
TITLE OF CASE <b>FREEDOM RIDE, 1961 Illinois Central Railroad New Orleans, Louisiana to Jackson, Mississippi July 9, 1961</b>		REPORT MADE BY <b>SA HUNTER E. HELGESON</b>	TYPED BY <b>mh</b>
		CHARACTER OF CASE  <b>RM; CR</b>	

REFERENCE:

Report of SA HUNTER E. HELGESON, 10/4/61at New Orleans.

-C-

ADMINISTRATIVE:

An additional copy of this report is designated for the New Orleans Office in the event the Bureau instructs that a copy be furnished to the USA, Jackson, Miss.

32 MAY 14 1962  
EX-113  
A

APPROVED <i>[Signature]</i>	SPECIAL AGENT IN CHARGE	DO NOT WRITE IN SPACES BELOW	
COPIES MADE: 4-Bureau (44-17797) 2-New Orleans (157-332)		157-387	1415
		16 MAY 31 1962	REC-4
DISSEMINATION RECORD OF ATTACHED REPORTS		NOTATION	
AGENCY Dept.	RECEIVED	<i>[Large Box]</i> b6 b7C	
REQUEST RECD.			
DATE FWD. 5/15/62			
HOW FWD. 6-94 (18)			
BY RHL:pp			

1 cc by unit  
MAY 21 1962

UNITED STATES DEPARTMENT OF JUSTICE  
FEDERAL BUREAU OF INVESTIGATION

## Copy to:

Report of: SA HUNTER E. HELGESON Office: NEW ORLEANS  
Date: 5/11/62  
Field Office File No.: NO 157-332 Bureau File No.: 44-17797

Title: FREEDOM RIDE, 1961  
Illinois Central Railroad  
New Orleans, Louisiana to  
Jackson, Mississippi  
July 9, 1961

Character: RACIAL MATTERS; CIVIL RIGHTS

## Synopsis:

Following individuals tried and convicted in Hinds County Court, Jackson, on Breach of Peace charges on dates indicated: [redacted] 12/22/61; [redacted] 4/3/62; [redacted] 4/11/62; [redacted] 4/17/62; Above individuals sentenced to four months in jail and fined \$200. All released on appeal bond. Following individuals entered pleas of nolo contendere to Breach of Peace charges in Hinds County Court, Jackson on dates indicated: [redacted] 4/2/62; [redacted] 4/9/62; [redacted] 4/16/62.

b6  
b7c

-C-

DETAILS:AT JACKSON, MISSISSIPPI:

On December 26, 1961, [redacted] Hinds County Sheriff's Office advised that on December 22, 1961 [redacted] was tried and convicted in Hinds County Court, Jackson on a Breach of the Peace charge. She advised that [redacted] was sentenced the same date to four months in jail, fined \$200 and released the same date on a \$1000 cash appeal bond plus a \$500 cash cost bond returnable in Hinds County Circuit Court, Jackson.

NO 157-332/mh

On April 9, 1962, City Prosecuting Attorney, J. A. TRAVIS, JR., City of Jackson, advised that on April 3, 1962 [redacted] was tried and convicted in Hinds County Court on a Breach of the Peace Charge. [redacted] was sentenced the same date to four months in jail and fined \$200. He was released the same date on a \$1000 cash appeal bond plus a \$500 cash cost bond returnable in Hinds County Circuit Court.

On April 17, 1962, Captain [redacted] Jackson Police Department, advised that on April 11, 1962, [redacted] was tried and convicted in Hinds County Court on a charge of Breach of the Peace. He said the defendant was sentenced the same date to four months in jail, fined \$200 and was released the same date on a \$1000 cash appeal bond, plus a \$500 cash cost bond returnable in Hinds County Circuit Court.

On April 24, 1962, Captain [redacted] advised that on April 17, 1962, [redacted] was tried and convicted in Hinds County Court on a charge of Breach of the Peace. [redacted] was sentenced the same date to four months in jail and fined \$200. He was released the same date on a \$1000 cash appeal bond, plus a \$500 cash cost bond returnable in Hinds County Circuit Court. b6 b7c

On April 9, 1962, City Prosecuting Attorney, J. A. TRAVIS, JR., City of Jackson, advised that he has received information that the transcripts of some of the first Freedom Rider trials in Hinds County Court wherein the defendants had been convicted and had appealed have now been prepared and have been forwarded to the Hinds County Circuit Court. He stated that no dates had yet been set for hearing of these appeals but they will not commence until at least May 1962.

On April 3, 1962, Captain [redacted] Jackson Police Department, advised that on April 2, 1962, an attorney representing [redacted] appeared in Hinds County Court, Jackson, and withdrew a plea of not guilty to a charge of Breach of the Peace which had previously been entered by his client. The attorney entered a plea of nolo contendere to this charge on behalf of [redacted]. On the same date [redacted] was adjudged guilty and sentenced to four months in jail, suspended, and fined \$200 which was paid by the attorney.



NO 157-332/mh

On April 17, 1962, Captain [redacted] advised that on April 9, 1962, an attorney representing [redacted] appeared in Hinds County Court, Jackson, and withdrew a plea of not guilty to a charge of Breach of the Peace which had previously been entered by his client. The attorney entered a plea of nolo contendere to this charge on behalf of [redacted]. On the same date [redacted] was adjudged guilty and sentenced to four months in jail, suspended, and fined \$200 which was paid by the attorney. b6 b7C

On April 17, 1962, Captain [redacted] advised that on April 16, 1962, an attorney representing [redacted] appeared in Hinds County Court and withdrew a plea of not guilty to a charge of Breach of the Peace which had previously been entered by his client. The attorney entered a plea of nolo contendere to this charge on behalf of [redacted]. On the same date, [redacted] was adjudged guilty and sentenced to four months in jail, suspended, and fined \$200 which was paid by the attorney.

UNITED STATES GOVERNMENT

# Memorandum

TO : DIRECTOR, FBI (157-387)

DATE: 5/21/62

FROM : SAC, ALBANY (157-21) (RUC)

SUBJECT: RIDERS - 1961  
FREEDOM RIDE, ROUTE 40,  
MARYLAND AND DELAWARE  
12/16/61  
RACIAL MATTERS

OO: BALTIMORE

b6  
b7c

Re New York letter to Director dated 4/23/62.

[redacted] Numeric Register Unit, New York State Department of Motor Vehicles, Albany, New York, advised IC [redacted] on 5/1/62, that her records revealed the following:

[redacted] issued to [redacted] New York, for a 1951 Chevrolet sedan, green in color, date of birth [redacted]

[redacted] issued to [redacted] New York, for a 1953 Chevrolet sedan, green in color, date of birth [redacted]

[redacted] issued to [redacted] New York, for a 1958 Opel sedan, red and white in color, date of birth [redacted]

[redacted] issued to [redacted] New York, for a 1955 Chevrolet sedan, wine and green in color, date of birth [redacted]

[redacted] further stated there is no such New York State issuance as RN 5438.

Albany indices negative on above-listed individuals.

- cc: ② - Bureau (RM)
- 1 - Baltimore (157-351) (RM)
- 1 - Albany

FLH/bsp  
(4)

348  
28 MAY 29 1962

REC-70

157-387-1416

13 MAY 23 1962

EX-114



F B I

Date: 5/23/62

Transmit the following in PLAIN TEXT  
(Type in plain text or code)

Via AIRTEL AIRMAIL  
(Priority or Method of Mailing)

TO: DIRECTOR, FBI (157-387)  
FROM: SAC, NEW ORLEANS (157-264)  
SUBJECT: FREEBUS

On 5/22/62, City Prosecuting Attorney, J. A. TRAVIS, JR., Jackson, Mississippi, advised that on 5/21/62 [redacted] one of the fifteen Episcopal clergymen arrested as Freedom Riders, was tried in Hinds County Court, Jackson on Breach of Peace charge, 5/21/62 and released upon a direct verdict of acquittal. After [redacted] acquittal TRAVIS requested the court to nolle pros the charges pending against the remaining fourteen clergymen.

b6  
b7C

TRAVIS advised that this concludes the trials of all Freedom Riders in Hinds County Court. He stated that the Hinds County Circuit Court has not as yet set any date for hearing the appeals of the convicted Freedom Riders.

New Orleans will discontinue submission of weekly summary airtels.

3-Bureau  
2-New Orleans  
HEH/dmt  
(5)

REC-23 157-387-1417

MAY 25 1962



b6  
b7C

C. C. Wick

JUN 6 1962

EX-115

Approved: \_\_\_\_\_ Sent \_\_\_\_\_ M Per \_\_\_\_\_  
Special Agent in Charge

# FEDERAL BUREAU OF INVESTIGATION

REPORTING OFFICE <b>NEW ORLEANS</b>	OFFICE OF ORIGIN <b>NEW ORLEANS</b>	DATE <b>5/24/62</b>	INVESTIGATIVE PERIOD <b>10/24/61 - 4/30/62</b>
TITLE OF CASE <b>FREEDOM RIDE, 1961 Trailways Bus Terminal Jackson, Mississippi, July 9, 1961</b>		REPORT MADE BY <b>SA HUNTER E. HELGESON</b>	TYPED BY <b>SW</b>
		CHARACTER OF CASE <b>RM; CR</b>	

REFERENCES:

Report of SA HUNTER E. HELGESON, 9/27/61, New Orleans.

-C-

ADMINISTRATIVE:

An additional copy of this report is designated for the New Orleans Office in the event the Bureau instructs that a copy be furnished the USA, Jackson, Mississippi.

A\*

COVER      PAGE

EXP-PROC  
347

APPROVED <i>[Signature]</i>	SPECIAL AGENT IN CHARGE	DO NOT WRITE IN SPACES BELOW	
COPIES MADE: 4 - Bureau (44-17831) 2 - New Orleans (157-334)		157-387-1410	REC-32
		11 MAY 28 1962	EX-100
DISSEMINATION RECORD OF ATTACHED REPORT			
AGENCY	DATE FWD.	BY	
W/60 JUN 6 1962	5/29/62	Mass: pp	
REQUEST RECD.	HOW FWD.		
	6-94 (18)		

*[Large diagonal stamp: STAFF SELECT]*

UNITED STATES DEPARTMENT OF JUSTICE  
FEDERAL BUREAU OF INVESTIGATION

Copy to:

Report of: SA HUNTER E. HELGESON Office: NEW ORLEANS  
Date: MAY 24, 1962

Field Office File No.: 157-334 Bureau File No.: 44-17831

Title: FREEDOM RIDE, 1961 Trailways  
Bus Terminal, Jackson, Mississippi  
July 9, 1961

Character: RACIAL MATTERS;  
CIVIL RIGHTS

Synopsis: The following individuals were tried and convicted in Hinds County Court, Jackson, Miss. on Breach of Peace charges on dates indicated: [redacted] 10/24/61; [redacted] 4/3/62; [redacted] 4/17/62; [redacted] 4/12/62; [redacted] 4/12/62; [redacted] 4/24/62. All above sentenced to 4 mos. in jail and fined \$200. Released same date as sentenced on appeal bond. [redacted] tried in Hinds County Court 1/5/62 on Breach of Peace charge. He was released same date on directed verdict of acquittal.

-C-

b6  
b7cDETAILS:AT JACKSON, MISSISSIPPI

On October 24, 1961, [redacted] Hinds County Circuit Clerk's Office, advised SA [redacted] that on that date [redacted] was tried in Hinds County Court on a Breach of the Peace charge. She was convicted and sentenced the same date to four months in jail and fined \$200. On the same date she was released on a \$1,000. cash appeal bond plus a \$500. cash cost bond, both returnable in Hinds County Circuit Court.

On April 9, 1962, City Prosecuting Attorney J. A. TRAVIS, JR., City of Jackson, advised that on April 3, 1962, [redacted] was tried and convicted in Hinds

NO. (157-334)

County Court on a Breach of the Peace charge. He was sentenced the same date to four months in jail and fined \$200. He was released on a \$1,000. cash appeal bond plus a \$500. cash cost bond the same date.

On April 17, 1962 Captain [redacted] Police Department, advised that on April 12, 1962 [redacted] and [redacted] were tried and convicted in Hinds County Court on a charge of Breach of the Peace. Both were sentenced the same date to four months in jail and fined \$200. Both were released the same date on \$1,000. cash appeal bonds plus \$500. cash cost bonds, returnable in Hinds County Circuit Court.

On April 24, 1962 Captain [redacted] advised that on April 17, 1962 [redacted] was tried and convicted, *MISE* Hinds County Court, Jackson, on a charge of Breach of the Peace. He was sentenced the same date to four months in jail and fined \$200. He was released the same date on \$1,000. cash appeal bond plus a \$500. cost bond, returnable in Hinds County Circuit Court. b6  
b7C

On April 30, 1962, Captain [redacted] advised that on April 24, 1962 [redacted] was tried and convicted in *MISE* Hinds County Court on a charge of Breach of the Peace. He was sentenced the same date to four months in jail and fined \$200. He was released the same date on a \$1,000. cash appeal bond plus a \$500. cash cost bond, returnable in Hinds County Circuit Court.

On April 9, 1962, City Prosecuting Attorney, J. A. TRAVIS, JR., advised that he had recently received word that transcripts of some of the first Freedom Rider trials in Hinds County Court wherein the defendants have been convicted and appealed, have now been prepared and have been forwarded to the Hinds County Circuit Court. He stated that no dates have yet been set for hearing of these appeals.

NO (157-334)

On January 8, 1962 Captain [redacted] advised that on January 5, 1962 [redacted] was tried in Hinds County Court on a Breach of the Peace charge. [redacted] was released on a directed verdict of acquittal upon motion for same by Defense Council.

b6  
b7C

# FEDERAL BUREAU OF INVESTIGATION

REPORTING OFFICE <b>NEW ORLEANS</b>	OFFICE OF ORIGIN <b>NEW ORLEANS</b>	DATE <b>5/24/62</b>	INVESTIGATIVE PERIOD <b>3/13 - 4/30/62</b>
TITLE OF CASE <b>FREEDOM RIDE, 1961 Greyhound Bus, Nashville, Tennessee, to Jackson, Mississippi, July 16, 1961</b>		REPORT MADE BY <b>SA HUNTER E. HELGESON</b>	TYPED BY <b>SW</b>
		CHARACTER OF CASE <b>RM; CR</b>	

CC TO: *USCG*  
REQ. REC'D *7-15*  
AUG 2 1965  
ANS. BY: *Ally-Jar*

REFERENCES:

Report of SA HUNTER E. HELGESON, 9/27/61, New Orleans:

C

ADMINISTRATIVE:

An additional copy of this report is designated for the New Orleans Office in the event the Bureau instructs that a copy be furnished the USA, Jackson, Mississippi.

*photo*  
CC TO: *Adid*  
REQ. REC'D *12-17*  
DEC 30 1964  
ANS. BY: *Boydah*

A\*

COVER PAGE

COPIES  
1  
2  
3  
4  
5  
6  
7  
8  
9  
10  
11  
12  
13  
14  
15  
16  
17  
18  
19  
20  
21  
22  
23  
24  
25  
26  
27  
28  
29  
30  
31  
32  
33  
34  
35  
36  
37  
38  
39  
40  
41  
42  
43  
44  
45  
46  
47  
48  
49  
50

APPROVED <i>HGM</i>	SPECIAL AGENT IN CHARGE	DO NOT WRITE IN SPACES BELOW	
COPIES MADE: 4 - Bureau (44-17831) 2 - New Orleans (157-346)		157-387-1419	REC-13
		MAY 9	EX-11A
			b6 b7C

DISSEMINATION RECORD OF ATTACHED REPORT

AGENCY	Request		
REQUEST RECD.			
DATE FWD.	5/29/62		
HOW FWD.	6-24 (W)		
BY	new pp		

1cc org unit  
51 JUN 9 1962



UNITED STATES DEPARTMENT OF JUSTICE  
FEDERAL BUREAU OF INVESTIGATION

## Copy to:

Report of: SA HUNTER E. HELGESON Office: NEW ORLEANS  
Date: MAY 24, 1962  
Field Office File No.: 157-346 Bureau File No.: 44-17831  
Title: FREEDOM RIDE,  
Greyhound Bus,  
Nashville, Tennessee  
to Jackson, Mississippi  
7/16/61  
Character: RACIAL MATTERS;  
CIVIL RIGHTS

## Synopsis:

The following individuals were tried and convicted in Hinds County Court, Jackson, Miss. on Breach of Peace charges on dates indicated: [redacted] 3/20/62; [redacted] 4/3/62. Above individuals sentenced to 4 mos. in jail and fined \$200. Released on appeal bond. The following individuals entered pleas of Nolo Contendere to Breach of Peace charges in Hinds County Court on dates indicated: [redacted] 3/12/62; [redacted] 3/26/62; [redacted] 4/9/62; [redacted] 4/23/62; [redacted] 4/30/62. Above individuals sentenced to 4 mos. in jail, suspended, and fined \$200.

-C-

DETAILS:AT JACKSON, MISSISSIPPI

On March 22, 1962 Captain [redacted] Jackson Police Department, advised that on March 20, 1962 [redacted] was tried and convicted in Hinds County Court, Jackson, Mississippi on a charge of Breach of the Peace. He was sentenced the same date to four months in jail and fined \$200. He was released the same date on a \$1,000 cash appeal bond, plus a \$500 cash cost bond, returnable in Hinds County Circuit Court, Jackson, Mississippi.



NO (157-346)

On April 9, 1962 City Prosecuting Attorney, J. A. TRAVIS, JR., City of Jackson, advised that on April 3, 1962 [redacted] was tried and convicted in Hinds County Court on a charge of Breach of the Peace. He was sentenced to four months in jail and fined \$200. He was released the same date on a \$1,000 cash appeal bond, plus a \$500 cash cost bond, returnable in Hinds County Circuit Court.

Miss  
Terrell

On April 9, 1962 Mr. TRAVIS advised that he had recently received information that the transcripts of some of the first Freedom Rider trials in Hinds County Court wherein the defendants had been convicted and had appealed, have now been prepared and have been forwarded to the Hinds County Circuit Court. He stated that no dates have yet been set for hearing these appeals.

b6  
b7C

On April 30, 1962 Captain [redacted] Jackson Police Department, advised that on the dates indicated the following individuals represented by an attorney, withdrew previous not guilty pleas to charges of Breach of the Peace in Hinds County Court. The attorney acting in their behalf then entered pleas of Nolo Contendere to this charge. All were adjudged guilty and all were sentenced to four months in jail, suspended, and fined \$200. The fine was paid:

[redacted] March 12, 1962; [redacted]  
[redacted] March 26, 1962; [redacted] April 9, 1962;  
[redacted] April 23, 1962; [redacted]  
[redacted] April 30, 1962.

Miss  
Terrell

# FEDERAL BUREAU OF INVESTIGATION

ALL INFORMATION CONTAINED  
HEREIN IS UNCLASSIFIED

REPORTING OFFICE <b>NEW ORLEANS</b>	OFFICE OF ORIGIN <b>NEW ORLEANS</b>	DATE <b>5/24/62</b>	DATE INVESTIGATIVE PERIOD <b>11/22/61 - 4/30/62</b>
TITLE OF CASE <b>FREEDOM RIDE, 1961 Greyhound Bus Nashville, Tennessee to Jackson, Mississippi July 21, 1961</b>		REPORT MADE BY <b>SA HUNTER E. HELGESON</b>	TYPED BY <b>SW</b>
		CHARACTER OF CASE <b>RM; CR</b>	

REFERENCES:

Report of SA HUNTER E. HELGESON, 9/27/61, New Orleans.

- C -

ADMINISTRATIVE:

An additional copy of this report is designated for the New Orleans Office in the event the Bureau instructs a copy be furnished the USA, Jackson, Mississippi.

A\*

COVER PAGE

EX-113  
137

APPROVED *[Signature]* SPECIAL AGENT IN CHARGE

COPIES MADE:  
4 - Bureau (157-387)  
2 - New Orleans (157-351)

DO NOT WRITE IN SPACES BELOW

157-387-142

MAY 28 1962

REC-49

EX-113

b6  
b7c

STATE SECT

DISSEMINATION RECORD OF ATTACHED REPORT

AGENCY	Dept.		
REQUEST RECD.			
DATE FWD.	5/29/62		
HOW FWD.	6-44 (15)	1/6	
BY	How: pp		

1 cc JUN 6 1962

UNITED STATES DEPARTMENT OF JUSTICE  
FEDERAL BUREAU OF INVESTIGATION

ALL INFORMATION CONTAINED  
HEREIN IS UNCLASSIFIED  
DATE 11-30-2009 BY 60324 UC BAW/SAB/MJS

Copy to:

Report of: SA HUNTER E. HELGESON Office: NEW ORLEANS  
Date: 5/24/62  
Field Office File No.: NO 157-351 Bureau File No.: 157-387  
Title: FREEDOM RIDE, 1961 Greyhound  
Bus, Nashville, Tennessee to  
Jackson, Mississippi - 7/21/61

Character: RACIAL MATTERS;  
CIVIL RIGHTS

Synopsis: On 11/22/61 [redacted] was released from  
Hinds County Jail, Jackson, Miss. upon expiration of sentence  
and payment of fine. On 3/20/62 [redacted] tried  
and convicted in Hinds County Court on Breach of Peace charge. b6  
Sentenced to 4 mos. in jail and fined \$200. Released on b7C  
appeal bond. On 3/12/62 plea of Nolo Contendere entered to  
Breach of Peace charge in Hinds County Court on behalf of  
[redacted] On 4/30/62 Plea of Nolo Contendere entered  
on behalf of [redacted] and [redacted] sentenced to  
4 mos. in jail suspended and fined \$200 each, paid.

-C-

DETAILS:AT JACKSON, MISSISSIPPI:

On November 22, 1961 Deputy [redacted] Hinds  
County Sheriff's Office, advised that on November 22, 1961  
[redacted] was released from custody in the Hinds  
County Jail, Jackson, Mississippi upon expiration of jail  
sentence and payment of balance of fine and costs.

On March 22, 1962, Captain [redacted] Jackson,  
Police Department, advised that on March 20, 1962, [redacted]  
[redacted] was tried and convicted in Hinds County  
Court, Jackson, on a charge of Breach of the Peace. She  
was sentenced the same date to four months in jail and

*MISS*

NO (157-351)

fined \$200. She was released the same date on a \$1,000. cash bond, plus a \$500. cash cost bond, returnable in Hinds County Circuit Court.

On April 9, 1962, City Prosecuting Attorney, J. A. TRAVIS, JR., CITY OF JACKSON, advised that he had recently received information that the transcripts of some of the first Freedom Rider trials in Hinds County Court, wherein the defendants had been convicted and had appealed, have now been prepared and have been forwarded to the Hinds County Circuit Court. He stated that no date has yet been set for hearing these appeals.

On March 13, 1962 Captain [redacted] Jackson Police Department, advised that on March 12, 1962 an attorney representing [redacted] appeared in Hinds County Court and withdrew a plea of not guilty to a Breach of the Peace charge, which had previously been answered by his client. The attorney entered a plea of Nolo Contendere to this charge on behalf of his client. [redacted] was adjudged guilty and sentenced to four months in jail suspended, and fined \$200. The fine was paid.

*Tenn  
Miss*

b6  
b7c

On April 30, 1962 Captain [redacted] advised that on April 30, 1962 an attorney representing [redacted] appeared in Hinds County Court and withdrew a plea of not guilty to a Breach of the Peace charge, which had previously been entered by his client. The attorney then entered a plea of Nolo Contendere to this charge for his client. The defendant was adjudged guilty and sentenced the same date to four months in jail suspended and fined \$200, which was paid by the attorney.

*Tenn  
Miss*

# FEDERAL BUREAU OF INVESTIGATION

REPORTING OFFICE <b>NEW ORLEANS</b>	OFFICE OF ORIGIN <b>NEW ORLEANS</b>	DATE <b>5/31/62</b>	INVESTIGATIVE PERIOD <b>10/9/61 - 5/1/62</b>
TITLE OF CASE <b>0 FREEDOM RIDE's 1961 Trailways Bus Montgomery, Alabama to Jackson, Mississippi 6/21/61</b>		REPORT MADE BY <b>SA HUNTER E. HELGESON</b>	TYPED BY <b>dr</b>
		CHARACTER OF CASE <b>RM; CR</b>	

Photo  
FBI  
MAR 23 1962  
EX-114  
b6  
b7C  
33

REFERENCE:

Report of SA HUNTER E. HELGESON dated 10/6/61 at Orleans.

- C -

ADMINISTRATIVE:

An additional copy of this report is designated for the New Orleans Office in the event the Bureau instructs that a copy be furnished the U. S. Attorney, Jackson, Mississippi.

1 XC - Treasury / OCC  
1 XC - Fed. Reserve Board  
Cre [Redacted]

4/leadu/af

APPROVED <i>[Signature]</i>	SPECIAL AGENT IN CHARGE	DO NOT WRITE IN THESE SPACES
COPIES MADE 4-Bureau (157-387) 2-New Orleans (157-313)		157-387 REC-16
		EX-114

DISSEMINATION RECORD OF ATTACHED REPORT

AGENCY	REQUEST RECD.	DATE FWD.	HOW FWD.	BY
Dept		6/5/62		
		6-9-62		

1 c.c. org unit

58 JUN 12 1962

UNITED STATES DEPARTMENT OF JUSTICE  
FEDERAL BUREAU OF INVESTIGATION

Copy for:

Report of:  
Date:SA HUNTER E. HELGESON  
May 31, 1962

Office: NEW ORLEANS

Field Office File No.:

NO 157-313

Bureau File No.:

157-387

Title:

FREEDOM RIDE, 1961  
Trailways Bus  
Montgomery, Alabama to  
Jackson, Mississippi  
6/21/61

Character:

RACIAL MATTER; CIVIL RIGHTS

Synopsis:

The following individuals tried and convicted in Hinds County Court, Jackson, Miss. on breach of peace charges on the dates indicated: [redacted] 10/10/61; [redacted] 12/13/61; [redacted] 12/19/61; [redacted] 4/30/62. Above individuals sentenced to four months in jail and fined \$200. All released on appeal bonds, date of sentence. The following individuals entered pleas of "nolo contendere" to breach of peace charges in Hinds County Court on dates indicated: [redacted] 10/9/61; [redacted] 11/20/61; [redacted] 1/8/62; [redacted] 1/8/62. These individuals sentenced to four months in jail, suspended and fined \$200.

b6  
b7c

- C -

DETAILS:AT NEW ORLEANS, LOUISIANA

On October 10, 1961, City Prosecuting Attorney, J. A. TRAVIS, JR., City of Jackson, advised SA [redacted] that [redacted] was tried and convicted in Hinds County Court, Jackson, Mississippi, on a breach of the peace charge on October 10, 1961. [redacted] was sentenced the same date to four months in jail and fined \$200. She was released the same date on a \$1,000 cash appeal bond plus a \$500 cash cost bond returnable in Hinds County Circuit Court, Jackson, Mississippi.



On December 15, 1961, [redacted] Hinds County Sheriff's Office, advised that on December 13, 1961, [redacted] was tried and convicted in Hinds County Court on a charge of breach of the peace. He was sentenced the same date to four months in jail and fined \$200. He was released the same date on a \$1,000 cash appeal bond, plus a \$500 cash cost bond returnable in Hinds County Circuit Court.

On December 26, 1961, [redacted] advised that on December 19, 1961, [redacted] was tried and convicted in Hinds County Court on a breach of the peace charge. She advised that [redacted] was sentenced the same date to four months in jail, and fined \$200 and released the same date on a \$1,000 cash appeal bond plus a \$500 cash cost bond, returnable in Hinds County Circuit Court.

b6  
b7c

On April 30, 1962, Captain [redacted] Jackson Police Department, advised that on April 30, 1962, [redacted] was tried and convicted in Hinds County Court, Jackson, Mississippi on a charge of breach of the peace. She was sentenced the same date to four months in jail and fined \$200. She was released the same date on a \$1,000 cash appeal bond, plus a \$500 cash cost bond returnable in Hinds County Circuit Court.

On April 9, 1962, City Prosecuting Attorney, J. A. TRAVIS, JR., advised that he had recently received information that the transcripts of some of the first freedom rider trials in Hinds County Court wherein the defendants had been convicted and had appealed, have now been prepared, and have been forwarded to the Hinds County Circuit Court. He stated that no date has yet been set for hearing of these appeals.

On October 9, 1961, [redacted] Hinds County Circuit Clerk's Office, advised SA [redacted] that on October 9, 1961, Attorney [redacted] appeared in Hinds County Court, representing [redacted] who was not present. [redacted] withdrew a previous not guilty plea which had been entered by [redacted] and entered a plea of "nolo contendere" to a breach of the peace charge on behalf of his client. [redacted] was adjudged guilty and sentenced to



NO 157-313/dr

Four months in jail, suspended, and fined \$200 which fine was paid by Attorney [redacted]

On November 20, 1961, City Prosecuting Attorney, J. A. TRAVIS, JR., City of Jackson, advised that on November 20, 1961, attorney [redacted] representing [redacted] appeared in Hinds County Court. [redacted] withdrew [redacted] previously entered not guilty plea to a breach of the peace charge and entered a plea of "nolo contendere" to the same charge in [redacted] behalf. [redacted] was adjudged guilty and sentenced the same date to four months in jail, suspended, and fined \$200. [redacted] paid the fine.

b6  
b7c

On January 8, 1962, Captain [redacted] Jackson Police Department, advised that on January 8, 1962, Attorney [redacted] appeared in Hinds County Court, representing the following individuals:

[redacted]  
[redacted]

[redacted] advised that [redacted] withdrew a plea of not guilty which had previously been entered by the above persons to breach of the peace charges, and entered a plea of "nolo contendere" to these charges on behalf of his clients. Each of the above was adjudged guilty and sentenced the same date to four months in jail, suspended, and each fined \$200. The fines were paid by [redacted]

# FEDERAL BUREAU OF INVESTIGATION

REPORTING OFFICE <b>NEW ORLEANS</b>	OFFICE OF ORIGIN <b>NEW ORLEANS</b>	DATE <b>5/29/62</b>	INVESTIGATIVE PERIOD <b>3/22 - 4/30/62</b>
TITLE OF CASE <b>FREEDOM RIDE, 1961 Illinois Central Railroad New Orleans, Louisiana, to Jackson, Mississippi 7/30/61</b>		REPORT MADE BY <b>SA HUNTER E. HELGESON</b>	TYPED BY <b>lrs</b>
		CHARACTER OF CASE <b>RM; CR</b>	

*photo*  
CC TO: CSC... - P.O.  
REQ. REC'D 1-24-67  
FEB 3 1967  
ANS. BY: [Signature]

REFERENCES:

Report of SA HUNTER E. HELGESON, 10/4/61, at New Orleans.

- C -

ADMINISTRATIVE:

An additional copy of this report is designated for the New Orleans Office in the event the Bureau instructs that a copy be furnished the United States Attorney, Jackson, Mississippi.

*photo*  
CC TO: OSI  
REQ. REC'D 12-30-61  
DEC 29 1965  
ANS. BY: [Signature]

CC TO: [Signature]  
REQ. REC'D 3/1/62  
APR 1 1965  
ANS. BY: [Signature]

REC'D REC'D  
CC TO: [Signature]  
WAB 10 1962

APPROVED: [Signature] SPECIAL AGENT IN CHARGE

COPIES MADE:  
4-Bureau (157-385)  
2-New Orleans (157-342)

DO NOT WRITE IN SPACES BELOW  
157-387-122  
REC-62

50 JUN 11 1962

AGENCY	Dept.		
REQUEST REC'D			
DATE FWD.	6/6/62		
HOW FWD.	6-94 (P)		
BY	Rbl: ppy		

STAT. [Signature]  
CC TO: [Signature]  
REQ. REC'D 5-23-66  
JUN 8 1966  
ANS. BY: [Signature]

1cc by unit

UNITED STATES DEPARTMENT OF JUSTICE  
FEDERAL BUREAU OF INVESTIGATION

Copy to:

Report of: SA HUNTER E. HELGESON Office: NEW ORLEANS  
Date: 5/29/62

Field Office File No.: NEW ORLEANS (157-342) Bureau File No.: (157-385)

Title: FREEDOM RIDE, 1961  
Illinois Central Railroad  
New Orleans, Louisiana, to  
Jackson, Mississippi  
7/30/61

Character: RACIAL MATTERS; CIVIL RIGHTS

Synopsis:

The following individuals tried and convicted in Hinds Co. Court, Jackson, Miss., on breach of peace charges on dates indicated: [redacted] 3/19/62; [redacted] 3/19/62; [redacted] 3/21/62; [redacted] 3/27/62; [redacted] 3/28/62; [redacted] 3/27/62; [redacted] 3/29/62; [redacted] 4/10/62; [redacted] 4/11/62; [redacted] 4/17/62; [redacted] 4/23/62; [redacted] 4/23/62. Above individuals sentenced to 4 months in jail and fined \$200 on dates of conviction. All released same date on appeal bond. On 4/30/62, [redacted] entered plea of nolo contendere to breach of peace charge in Hinds Co. Court; was sentenced to 4 months in jail, suspended and fined \$200. On 2/16/62, [redacted] was released from jail upon expiration of sentence.

b6  
b7c

- C -

DETAILS:

AT JACKSON, MISSISSIPPI

On March 22, 1962, Captain [redacted] Jackson Police Department, advised that on the dates indicated, the following individuals were tried and convicted in Hinds County Court, Jackson, Mississippi, on a charge of breach of the peace. Each were sentenced the same date as convicted, to four months in jail and fined \$200. Each was released the same date on a \$1000 cash appeal bond, plus a \$500 cash costs bond, returnable in Hinds County Circuit Court, Jackson, Mississippi:

422

NO 157-342

[redacted] March 19, 1962; [redacted] March 19, 1962; [redacted] March 21, 1962;

On April 3, 1962, Captain [redacted] advised that on the dates indicated, the following individuals were tried and convicted in Hinds County Court on breach of the peace charges. Each was sentenced to four months in jail and fined \$200. Each was released the same date as convicted on \$1000 cash appeal bond plus \$500 cash costs bond, returnable in Hinds County Circuit Court. b6 b7C

[redacted] March 27, 1962; [redacted] March 28, 1962; [redacted] March 27, 1962; [redacted] March 29, 1962.

On April 17, 1962, Captain [redacted] advised that on the dates indicated, the following individuals were tried and convicted in Hinds County Court on charges of breach of the peace. Each was sentenced the same date to four months in jail and fined \$200. Each was released the same date on a \$1000 cash appeal bond, plus a \$500 cash costs bond, returnable in Hinds County Circuit Court:

[redacted] April 10, 1962; [redacted] April 11, 1962;

On April 24, 1962, Captain [redacted] advised that on the dates indicated, the following individuals were tried and convicted in Hinds County Court on charges of breach of the peace. Each was sentenced the same date to four months in jail and fined \$200. Each was released the same date on \$1000 cash appeal bond, plus a \$500 cash costs bond returnable in Hinds County Circuit Court:

[redacted] April 17, 1962; [redacted] April 23, 1962; [redacted] April 23, 1962.

On April 9, 1962, City Prosecuting Attorney, J. A. TRAVIS, JR., City of Jackson, advised that he recently received information that the transcripts of some of the first Freedom Rider trials in Hinds County Court wherein the defendants had been convicted and appealed, had now been prepared and had been forwarded to the Hinds County Circuit Court.

NO 157-342

He stated that no date has yet been set for hearing these appeals.

On April 30, 1962, Captain [redacted] advised that on April 30, 1962, an attorney representing [redacted] appeared in Hinds County Court and withdrew a plea of not guilty to a breach of the peace charge, which had been previously entered by his client. The attorney then entered a plea of nolo contendere to this charge for his client. The defendant was adjudged guilty and sentenced the same date to four months in jail, suspended, and fined \$200 which was paid by the attorney.

On March 10, 1962, [redacted] Hinds County Jail, advised that on February 16, 1962, [redacted] was released from jail upon expiration of sentence.

b6  
b7C



# FEDERAL BUREAU OF INVESTIGATION

REPORTING OFFICE <b>NEW ORLEANS</b>	OFFICE OF ORIGIN <b>NEW ORLEANS</b>	DATE <b>5/29/62</b>	INVESTIGATIVE PERIOD <b>9/27/61 - 4/30/62</b>
TITLE OF CASE <b>FREEDOM RIDE, 1961 Illinois Central Railroad, New Orleans, Louisiana to Jackson, Mississippi July 23, 1961</b>		REPORT MADE BY <b>SA HUNTER E. HELGESON</b>	TYPED BY <b>lrs</b>
		CHARACTER OF CASE <b>RM; CR</b>	

REFERENCES:

Report of SA HUNTER E. HELGESON dated 9/27/61 at New Orleans.

- C -

ADMINISTRATIVE:

An additional copy of this report is designated for the New Orleans Office in the event the Bureau instructs that a copy be furnished to the United States Attorney, Jackson, Mississippi.

ALL INFORMATION CONTAINED  
HEREIN IS UNCLASSIFIED  
DATE 11/1/90 BY SP-7 mac/DB  
#326,175

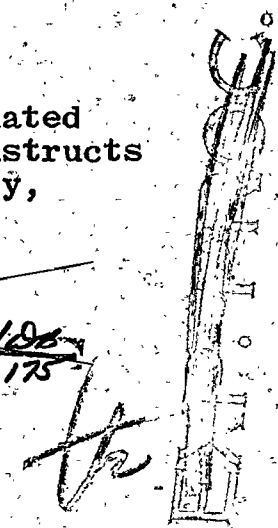

APPROVED: *[Signature]* SPECIAL AGENT IN CHARGE

COPIES MADE:  
4-Bureau (44-17797)

2-New Orleans (157-354)

U.S. DEPT. OF JUSTICE  
F. B. I.

JUN 1 15 08 PM '62

DO NOT WRITE IN SPACES BELOW

157-387-1423 REC-20

JUN 1 1962

EX-114

DISSEMINATION RECORD OF ATTACHED REPORTS

AGENCY	Request	GENERAL INVESTIGATIVE DIVISION
REQUEST RECD.		RECEIVED
DATE FWD.	6/6/62	
HOW FWD.	62-94 (B)	
BY	RECORDED	

NOTA

b6  
b7c

STAT. SECT.

icc org. unit

UNITED STATES DEPARTMENT OF JUSTICE  
FEDERAL BUREAU OF INVESTIGATION

## Copy to:

Report of: SA HUNTER E. HELGESON Office: NEW ORLEANS  
Date: 5/29/62

Field Office File No.: NEW ORLEANS (157-354) Bureau File No.: (44-17797)

Title: FREEDOM RIDE, 1961,  
Illinois Central Railroad,  
New Orleans, Louisiana to  
Jackson, Mississippi  
July 23, 1961

## Character:

RACIAL MATTERS; CIVIL RIGHTS

## Synopsis:

On 11/27/61, [redacted] released from custody Hinds Co. Jail upon expiration of sentence and payment of balance of fine. [redacted] failed to appear for trial in Hinds Co. Court, Jackson, on 3/19/62 and bond forfeiture ordered. The following individuals entered pleas of nolo contendere to charges of breach of the peace in Hinds Co. Court on dates indicated: [redacted] 4/16/62; [redacted] 4/16/62; [redacted] 4/16/62; [redacted] 4/23/62; [redacted] 4/30/62.

- C -

DETAILS:AT JACKSON, MISSISSIPPI

On November 27, 1961, Deputy [redacted] Hinds County Sheriff's Office, advised that on November 27, 1961, [redacted] was released from custody in the Hinds County Jail upon expiration of jail sentence and payment of balance of fine and costs.

On March 22, 1962, Captain [redacted] Jackson Police Department, advised that [redacted] failed to appear for trial in Hinds County Court on breach of the peace charges on March 19, 1962 as scheduled. The court ordered a bond forfeiture.

On April 30, 1962, Captain [redacted] advised that on the dates indicated, an attorney appeared in Hinds County Court representing the following individuals:



NO 157-354

The attorney withdrew pleas of not guilty to breach of the peace charges which had previously been entered by these individuals. He then entered a plea of nolo contendere to these charges on behalf of each of these individuals. On the same date as indicated, each individual was adjudged guilty and sentenced to four months in jail suspended, and fined \$200. which was paid by the attorney:

[redacted] April 16, 1962; [redacted]  
[redacted] April 16, 1962; [redacted] April 16, 1962;  
[redacted] April 23, 1962; [redacted] April  
30, 1962.

b6  
b7C

# FEDERAL BUREAU OF INVESTIGATION

REPORTING OFFICE <b>NEW ORLEANS</b>	OFFICE OF ORIGIN <b>NEW ORLEANS</b>	DATE <b>5/31/62</b>	INVESTIGATIVE PERIOD <b>4/30/62</b>
TITLE OF CASE <b>FREEDOM RIDE, 1961 MORTON BRUCE SLATER Illinois Central Railroad Depot, Jackson, Mississippi, July 8, 1961</b>		REPORT MADE BY <b>SA HUNTER E. HELGESON</b>	TYPED BY <b>lrs</b>
		CHARACTER OF CASE <b>RM; CR</b>	

REFERENCES:

Report of SA HUNTER E. HELGESON, 9/29/61 at New Orleans.

- C -

ADMINISTRATIVE:

An additional copy of this report is designated for the New Orleans Office in the event the Bureau instructs that a copy be furnished to the United States Attorney, Jackson, Mississippi.

322  
RECHER-2  
SAC  
MAY 31 1962  
FBI MOBILE

COPIES  
105

32

APPROVED <i>[Signature]</i>	SPECIAL AGENT IN CHARGE	DO NOT WRITE IN SPACES BELOW	
COPIES MADE: 4-Bureau (44-17797) 2-New Orleans (44-335)	157-387 DEPT OF JUSTICE FBI MAY 1 11 08 AM '62	157-387	1424 REC-105
DISSEMINATION RECORD OF ATTACHED REPORT		b6 b7c	
AGENCY REPT.	RECEIVED	STAT. SEC. UNIT	
REQUEST RECD.			
DATE FWD. 6/5/62			
HOW FWD. 6-94 (S) N Pub. pp			
BY			

54 JUN 14 1962

UNITED STATES DEPARTMENT OF JUSTICE  
FEDERAL BUREAU OF INVESTIGATION

Copy to:

Report of:  
Date:SA HUNTER E. HELGESON  
5/31/62

Office: NEW ORLEANS

Field Office File No.:

NEW ORLEANS (157-335)

Bureau File No.: (44-17797)

Title:

FREEDOM RIDE, 1961  
MORTON BRUCE SLATER  
Illinois Central Railroad Depot,  
Jackson, Mississippi, 7/8/61

Character:

RACIAL MATTERS; CIVIL RIGHTS

Synopsis:

[redacted] tried in Hinds Co. Court,  
Jackson, Miss., 4/24/62 on charge of breach of peace.  
Released same date after directed verdict of acquittal.

- C -

b6  
b7cDETAILS:

On April 30, 1962, Captain [redacted] Police  
Department, Jackson, Mississippi, advised that on April 24,  
1962, [redacted] was tried in Hinds County Court,  
Jackson, Mississippi, on a charge of breach of the peace.  
He was released the same date after a directed verdict of  
acquittal.

- 1\* -

ALL INFORMATION CONTAINED  
HEREIN IS UNCLASSIFIED  
DATE 11-30-2009 BY 60324UC BAW/SAB/MJS  
FBI

Mr. Tolson	_____
Mr. Belmont	_____
Mr. Mohr	_____
Mr. Callahan	_____
Mr. Conrad	_____
Mr. DeLoach	_____
Mr. Evans	_____
Mr. [unclear]	_____
Mr. [unclear]	_____
Mr. Sullivan	_____
Mr. Tavel	_____
Mr. Trotter	_____
Tele. Room	_____
Miss Holmes	_____
Miss Gandy	_____

Date: 5/21/62

PLAIN TEXT

Transmit the following in \_\_\_\_\_

(Type in plain text or code)

Via AIRTEL \_\_\_\_\_

AIR MAIL \_\_\_\_\_

(Priority or Method of Mailing)

TO: DIRECTOR, FBI

FROM: (H) SAC, MEMPHIS (157-162) (P)  
FREEDOM RIDERS - MISC.

SUBJECT: RACIAL SITUATION IN MISSISSIPPI  
SIT DOWN, ILLINOIS CENTRAL RAILROAD STATION,  
CLARKSDALE, MISSISSIPPI  
RM

b6  
b7c

Re Memphis airtel to Bureau 2/1/62.

Attached are eight copies of a letterhead memorandum concerning captioned matter.

The appeals filed by the defendants in this matter will be followed and the Bureau advised of any developments in this connection. It is noted the appeals are scheduled to be heard in the Circuit Court, Clarksdale, Mississippi, which court convenes the second Monday of July, 1962.

The information reported in the letterhead memorandum was furnished to SA [redacted]

b6  
b7c

ENCLOSURE 8

- 3- Bureau (Encl-8)
- 1- Memphis
- TSH: nmw
- (4)

REC-38 157-387-1425

JUN 17 1962

- Airtel.....
- Teletype.....
- A. M. ....
- A. A. S. D. ....
- Spec. Del. ....
- Reg. Mail.....
- Registered.....

Agency G-2, ONI, OSI, CRD

Date Forw. 6-6-62

How Forw. R-5

By FCW:cag

1 cc Org Unit  
2 cc's destroyed

ST-104

6-Flow

C. C. Wick

JUN 13 1962

Approved: \_\_\_\_\_

Sent \_\_\_\_\_ M

Per \_\_\_\_\_

Special Agent in Charge



UNITED STATES DEPARTMENT OF JUSTICE

FEDERAL BUREAU OF INVESTIGATION

1104 Sterick Building  
Memphis, Tennessee

May 31, 1962

In Reply, Please Refer to  
File No.

RE: RACIAL SITUATION IN MISSISSIPPI  
SIT DOWN, ILLINOIS CENTRAL RAILROAD  
STATION, CLARKSDALE, MISSISSIPPI  
RACIAL MATTERS

---

On May 24, 1962, Sheriff [redacted] Clarksdale, Mississippi, advised the appeals of [redacted] and [redacted] are scheduled for the Circuit Court, Clarksdale, Mississippi. He informed no information has come to his attention that any briefs have been filed in this matter. He stated Circuit Court will convene the second Monday of July, 1962.

b6  
b7c

This document contains neither recommendations nor conclusions of the FBI. It is the property of the FBI and is loaned to your agency; it and its contents are not to be distributed outside your agency.

157-387-1425  
ENCLOSURE

UNITED STATES GOVERNMENT

# Memorandum

ALL INFORMATION CONTAINED  
HEREIN IS UNCLASSIFIED  
DATE 11-30-2009 BY 60324 UC BAW/SAB/HJS

TO : DIRECTOR, FBI (44-17831)

DATE: 6/6/62

FROM : SAC, WFO (157-133) (RUC)

SUBJECT: FREEDOM RIDE 1961  
TRAILWAYS BUS,  
SHREVEPORT, LOUISIANA TO  
JACKSON, MISSISSIPPI  
8/4/61  
(OO:NO)

ReWFOlet to Director, dated 5/7/62.

The U.S. Supreme Court (USSC) handed down a written Per Curiam opinion on 6/4/62, in the case entitled, "LEVERT H. TAYLOR, ET AL vs. Louisiana", Case Number 773 Appellate, October Term, 1961. A copy of the Court's opinion is enclosed herewith for the Bureau. The first paragraph thereof reads as follows:

"Petitioners, six Negroes, were convicted of violating Louisiana's breach-of-the-peace statute, La. Rev. Stat., 1950, 14:103.1, and were given fines and jail terms by the state court. The Louisiana Supreme Court declined to review their convictions, and the case is here on petition for a writ of certiorari which we have granted."

The Court, in its opinion, stated the only evidence to support the charge was that petitioners were violating a custom that segregated people in waiting rooms according to their race, a practice not allowed in interstate transportation facilities by reason of federal law. The USSC reversed judgments of conviction in the lower court.

The petitioner's brief, referred to in referenced communication, was returned to [redacted] USSC, on 5/21/62.

As this matter has now been terminated in the USSC, no further action is being taken by WFO.

- 2 - Bureau (Enc - 1)
- 1 - New Orleans (157-363)
- 1 - WFO

157-387-1426

REC-65 5 JUN 7 1962

60 JUN 13 1962  
Rev. bji

ENCLOSURE

ENCLOSURE ATTACHED

b6  
b7c

✓  
**SUPREME COURT OF THE UNITED STATES**

LEVERT H. TAYLOR ET AL. v. LOUISIANA.

ON PETITION FOR WRIT OF CERTIORARI TO THE SUPREME  
COURT OF LOUISIANA.

No. 773. Decided June 4, 1962.

PER CURIAM.

" Petitioners, six Negroes, were convicted of violating Louisiana's breach-of-the-peace statute, La. Rev. Stat., 1950, § 14:103.1,<sup>1</sup> and were given fines and jail terms by the state court. The Louisiana Supreme Court declined to review their convictions, and the case is here on petition for a writ of certiorari which we have granted. ' ,

Four of the six petitioners went into the waiting room customarily reserved for white people at the Trailways Bus Depot in Shreveport, Louisiana, in order to take a bus to Jackson, Mississippi. The Chief of Police of Shreveport approached the four and asked them why they were in the station. They told him they were interstate passengers and wished to purchase tickets and obtain travel information. The Chief told them they could do this in the colored waiting room and ordered them to move on. When the four refused to leave, stating again that they were interstate passengers and asserting their rights under federal law, they were ordered to leave or be arrested. The spokesman of the group then said, "We have no choice; go ahead and arrest us." The police thereupon arrested the four of them. The other two petitioners were then arrested, while sitting nearby in the automobile which had brought the six to the bus station.

---

<sup>1</sup> In relevant part, § 14:103.1 provides: "A. Whoever with intent to provoke a breach of the peace, or under circumstances such that a breach of the peace may be occasioned thereby: (1) crowds or congregates with others . . . in or upon . . . any . . . public place or building . . . and who fails or refuses to disperse and move on, or disperse or move on, when ordered so to do by any law enforcement officer of any municipality . . . in which such act or acts are committed or by any law enforcement officer of the state of Louisiana . . . shall be guilty of disturbing the peace."

157-387-1426



At the trial there was testimony that immediately upon petitioners' entry into the waiting room many of the people therein became restless and that some onlookers climbed onto seats to get a better view. Nevertheless, respondent admits these persons moved on when ordered to do so by the police. There was no evidence of violence. The record shows that the petitioners were quiet, orderly, and polite. The trial court said, however, that the mere presence of Negroes in a white waiting room was likely to give rise to a breach of the peace. It held the mere presence of the Negroes in the waiting room, as part of a preconceived plan, was sufficient evidence of guilt. It accordingly held that the four had violated the state breach-of-the-peace statute and that the other two had counseled and procured the others to commit the crime.

Here, as in *Garner v. Louisiana*, 368 U. S. 157, the only evidence to support the charge was that petitioners were violating a custom that segregated people in waiting rooms according to their race, a practice not allowed in interstate transportation facilities by reason of federal law.<sup>2</sup> *Boynton v. Virginia*, 364 U. S. 454, 459-460. And see *Baltimore City v. Dawson*, 350 U. S. 877 (public beaches); *Holmes v. City of Atlanta*, 350 U. S. 879 (municipal golf courses); *Gayle v. Browder*, 352 U. S. 903 (bus); *New Orleans City Parks v. Detiege*, 358 U. S. 54 (municipal golf course and park). The judgments of conviction must therefore be

*Reversed.*

MR. JUSTICE HARLAN would grant certiorari and set the case for argument.

MR. JUSTICE FRANKFURTER took no part in the consideration or decision of this case.

---

<sup>2</sup> "That there exists a serious and difficult problem arising from a feeling of race hostility which the law is powerless to control, and to which it must give a measure of consideration, may be freely admitted. But its solution cannot be promoted by depriving citizens of their constitutional rights and privileges." *Buchanan v. Warley*, 245 U. S. 60, 80-81.

ALL INFORMATION CONTAINED  
HEREIN IS UNCLASSIFIED  
DATE 11-30-2009 BY 60324 UC BAW/SAB/MJS

F B I

Date: 6/6/62

Transmit the following in \_\_\_\_\_  
(Type in plain text or code)

Via AIRTEL AIR MAIL  
(Priority or Method of Mailing)

TO: DIRECTOR, FBI (157-387)  
FROM: SAC, JACKSONVILLE (157-250) (P)  
SUBJECT: FREEDOM RIDERS - MISC.  
"FREEBUS"  
RM

CORE  
RM

Re Jacksonville airtel to Bureau 5/8/62.

Records, Clerk's Office, Marion County Circuit Court, Ocala, Florida, as checked on 6/5/62, reflect Circuit Judge D. R. SMITH did not hear argument on motion of State Attorney \_\_\_\_\_ to dismiss appeals of convictions of three Freedom Riders, \_\_\_\_\_ and \_\_\_\_\_ on 6/4/62.

b6  
b7c

Judge SMITH has not reset date for above hearing.

Jacksonville will follow this matter closely, the Bureau will be advised of all future pertinent developments, and letterhead memo submitted concerning results of above hearing when known.

3-Bureau (RM)  
4-Jacksonville  
(1- 105-66) U.S. DEPT. OF JUSTICE  
(1- 105-82) FBI  
RHA:eas

REC-62

157-387-1427

18 JUN 7 1962

(7)

C C Wick

50 JUN 12 1962 EX-114

SIX

Approved: \_\_\_\_\_  
Special Agent in Charge

Sent \_\_\_\_\_ M Per \_\_\_\_\_

# FEDERAL BUREAU OF INVESTIGATION

REPORTING OFFICE <b>NEW ORLEANS</b>	OFFICE OF ORIGIN <b>NEW ORLEANS</b>	DATE <b>6/6/62</b>	INVESTIGATIVE PERIOD <b>4/9/62 - 5/22/62</b>
TITLE OF CASE <b>FREEDOM RIDE, 1961 NEW ORLEANS, LOUISIANA TO DEARBORN, MICHIGAN 9/11 - 16/61</b>		REPORT MADE BY <b>SA HUNTER E. HELGESON</b>	TYPED BY <b>mh</b>
		CHARACTER OF CASE  <b>RM; CR</b>	

REFERENCES:

Report of SA HUNTER E. HELGESON, 12/12/61 at New Orleans

-C-

ADMINISTRATIVE:

An additional copy of this report is designated for the New Orleans Office in the event the Bureau instructs that a copy be furnished the the United States Attorney, Jackson, Mississippi.

332 1201071 252

52 MAY 11 1962

EXP. PROC.  
31 JUN 8 1962

APPROVED <i>[Signature]</i>	SPECIAL AGENT IN CHARGE	DO NOT WRITE IN SPACES BELOW	
COPIES MADE: 4-Bureau (157-387) 2-New Orleans (157-385)		157-387-1420	REC-61
60 JUN 14 1962		16 JUN 8 1962	b6 b7c
DISSEMINATION RECORD OF ATTACHED REPORT		NOTATION	
AGENCY	DATE FWD.	HOW FWD.	BY
Dept.	6/11/62	6-94 (C)	Rbl:pp
REQUEST RECD.			

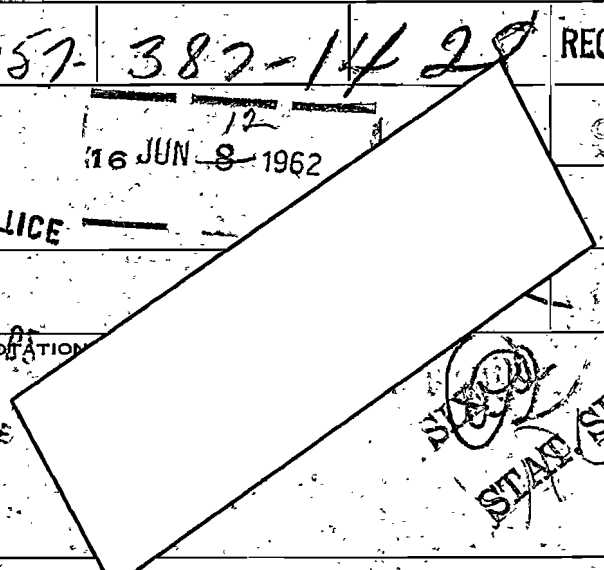

STATE SECT.

*df*

*Am*

*icc org. unit*

UNITED STATES DEPARTMENT OF JUSTICE  
FEDERAL BUREAU OF INVESTIGATION

ALL INFORMATION CONTAINED  
HEREIN IS UNCLASSIFIED  
DATE 11-30-2009 BY 60324 UC BAW/SAB/MJS

Copy to:

Report of: SA HUNTER E. HELGESON Office: NEW ORLEANS

Date: 6/6/62

Field Office File No.: NO 157-385

Bureau File No.: 157-387

Title: FREEDOM RIDE, 1961  
NEW ORLEANS, LOUISIANA TO  
DEARBORN, MICHIGAN  
9/11 - 16/61

Character: RACIAL MATTERS; CIVIL RIGHTS

Synopsis: On 4/9/62, attorneys for the below listed individuals appeared in the Hinds Co. Court and moved for directed verdict for these individuals. The State of Miss and City of Jackson joined motion.

b6  
b7c

Some of above individuals protested and court subsequently directed that all should be tried. On 5/21/62, [redacted] tried and released on directed verdict of acquittal. Charges against remaining 14 were nol prossed same date.

-C-

DETAILS:

On April 9, 1962, Mr. J. A. TRAVIS, JR., City Prosecuting Attorney, City of Jackson, Jackson, Mississippi, advised SA HUNTER E. HELGESON that on April 9, 1962, attorneys representing all of the Episcopal clergymen arrested as Freedom Riders September 13, 1961, appeared in Hinds County Court, Jackson, and made a motion for a directed verdict (dismissal) in behalf of each of these individuals. Mr. TRAVIS advised that the State of Mississippi and the City of Jackson joined in this motion. Mr. TRAVIS made available a copy of the order which reads as follows:

"TO: HONORABLE RUSSELL D. MOORE, III  
COUNTY JUDGE  
COUNTY COURT OF THE FIRST JUDICIAL DISTRICT OF  
HINDS COUNTY, MISSISSIPPI

"Re: State vs. [redacted] (Rosebury, Mass.)  
#12,928  
State vs. [redacted] (Cambridge, Mass.)  
#12,930  
State vs. [redacted] (Province, R. I.)  
#12,931  
State vs. [redacted] (St. Clair, Mo.)  
#12,933  
State vs. [redacted] (Chicago, Ill.)  
#12,941  
State vs. [redacted] (Atlanta, Ga.)  
#12,935  
State vs. [redacted] (New York City<sup>b6</sup>  
N. Y.) (#12,936<sup>b7C</sup>)  
State vs. [redacted] (Bewaukee, Wisc.)  
#12,937  
State vs. [redacted] (Chicago, Ill.)  
#12,942  
State vs. [redacted] (Washington, D. C.)  
#12,938  
State vs. [redacted] (Cincinnati, Ohio)  
#12,939  
State vs. [redacted] (Boston, Mass.)  
#12,940  
State vs. [redacted] (Teledo, Ohio)  
#12,932  
State vs. [redacted] (Washington, D. C.)  
#12,934  
State vs. [redacted] (Boston, Mass.)  
#12,929

"The State of Mississippi and the City of Jackson join in the motion for directed verdict (Dismissal) filed by each of the defendants in the above styled and numbered criminal causes.

"We do so out of respect and admiration for the Episcopal Church and Mississippi Episcopal Churchmen.

"This will permit each of these defendants to return to their priestly duties.

"/s/ J. A. TRAVIS, JR.  
Prosecuting Attorney for  
City of Jackson and Special  
Prosecutor for State of Missis-  
sippi"

NO 157-385/mh

On April 17, 1962, Captain [redacted] Jackson Police Department, advised that there was local publicity concerning the dismissal of these charges and some of these clergymen had appeared in Jackson protesting that if charges against them were dropped then charges against other Freedom Riders previously arrested should also be dropped. As a result of this Hinds County Judge RUSSELL MOORE, who had not at that time signed the order of dismissal, directed that the clergymen should appear and stand trial as originally scheduled.

b6  
b7c

On May 22, 1962 City Prosecuting Attorney, J. A. TRAVIS, JR., advised that on May 21, 1962, [redacted] was tried and released after a directed verdict of acquittal. As a result of this the charges against the remaining fourteen clergymen were not pressed inasmuch as the evidence against them was the same as against [redacted]



# FEDERAL BUREAU OF INVESTIGATION

REPORTING OFFICE <b>NEW ORLEANS</b>	OFFICE OF ORIGIN <b>NEW ORLEANS</b>	DATE <b>6/6/62</b>	INVESTIGATIVE PERIOD <b>3/26 - 4/30/62</b>
TITLE OF CASE <b>FREEDOM RIDE, 1961 Greyhound Bus, Nashville, Tennessee to Jackson, Mississippi, 7/29/61</b>		REPORT MADE BY <b>SA HUNTER E. HELGESON</b>	TYPED BY <b>lrs</b>
		CHARACTER OF CASE  <b>RM; CR</b>	
ALL INFORMATION CONTAINED HEREIN IS UNCLASSIFIED DATE 11-30-2009 BY 60324 UC BAW/SAB/MJS			

**REFERENCES:**

Report of SA HUNTER E. HELGESON, 10/4/61, at New Orleans.

- C -

**ADMINISTRATIVE:**

An additional copy of this report is designated for the New Orleans Office in the event the Bureau instructs that a copy be furnished to the United States Attorney, Jackson, Mississippi.

REC-61

*Am*

APPROVED <i>[Signature]</i>	SPECIAL AGENT IN CHARGE	DO NOT WRITE IN SPACES BELOW	
COPIES MADE:		<b>157-38</b>	<b>429</b>
4-Bureau (157-387) 2-New Orleans (157-358)		REC-61  b6 b7C	

*JK 659*  
**JUN 22 1962**

*JUN 8 15 SA BN 25*

DISSEMINATION RECORD OF ATTACHED REPORT			
AGENCY	REQUEST RECEIVED	DATE FWD.	HOW FWD.
<i>Dept</i>	<i>50 JUN 11 1962</i>	<i>6/11/62</i>	<i>6-94 (4)</i>
BY	<i>Rel: pp</i>		

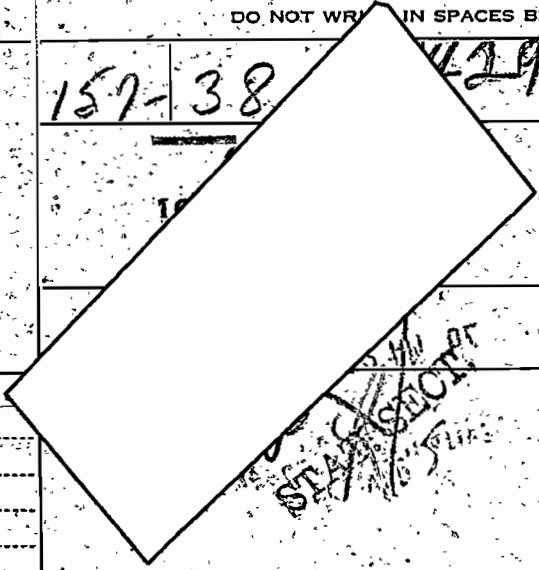

**SECRET**

*1 cc org. unit*

UNITED STATES DEPARTMENT OF JUSTICE  
FEDERAL BUREAU OF INVESTIGATION

ALL INFORMATION CONTAINED  
HEREIN IS UNCLASSIFIED  
DATE 11-30-2009 BY 60324 UC BAW/SAB/MJS

Copy to:

Report of: SA HUNTER E. HELGESON Office: NEW ORLEANS  
Date: 6/6/62  
Field Office File No.: NEW ORLEANS (157-358) Bureau File No.: (157-387)  
Title: FREEDOM RIDE, 1961  
Greyhound Bus, Nashville,  
Tennessee to Jackson,  
Mississippi, 7/29/61  
Character: RACIAL MATTERS; CIVIL RIGHTS

Synopsis:

The following individuals were tried and convicted in Hinds Co. Court, Jackson, Miss. on breach of peace charges on dates indicated: [redacted] 3/28/62; [redacted] 4/10/62; [redacted] 4/24/62. All sentenced same date as convicted to four months in jail and fined \$200. All released same date on appeal bond. Nolo contendere pleas to breach of peace charges entered in behalf of following individuals in Hinds Co. Court on dates indicated: [redacted] 3/26/62; [redacted] 4/16/62; [redacted] 4/23/62; [redacted] 4/30/62. Above individuals sentenced to four months in jail, suspended, and fined \$200, paid.

- C -

DETAILS:b6  
b7cAT JACKSON, MISSISSIPPI

On April 30, 1962, Captain [redacted] Jackson Police Department, advised that on the dates indicated below, the following individuals were tried and convicted in Hinds County Court, Jackson, Mississippi, on charges of breach of the peace. Each was sentenced the same date to four months in jail and fined \$200. Each was released the same date on a \$1000 cash appeal bond, plus a \$500 cash costs bond returnable in Hinds County Court:

[redacted] March 28, 1962 [redacted]  
[redacted] April 10, 1962 [redacted] April 24,  
1962.

NO 157-358

On April 9, 1962, City Prosecuting Attorney J. A. TRAVIS, JR., City of Jackson, advised that he had recently received information that the transcript of some of the first Freedom Rider trials in Hinds County Court wherein the defendants had been convicted and had appealed, had now been prepared and forwarded to the Hinds County Circuit Court. He stated that no dates have yet been set for hearing these appeals.

b6  
b7c

On April 30, 1962, Captain [REDACTED] RAY, Jackson Police Department, advised that on the dates indicated, an attorney representing the following individuals appeared in Hinds County Court and withdrew pleas of not guilty to a breach of the peace charge which had previously been entered by the following persons. He then entered a plea of nolo contendere to this charge on behalf of these individuals. Each was adjudged guilty the same date and sentenced to four months in jail, suspended, and fined \$200. The fine was paid by the attorney:

[REDACTED] March 26, 1962; [REDACTED]  
[REDACTED] April 16, 1962; [REDACTED] April 23, 1962;  
[REDACTED] April 30, 1962.

# FEDERAL BUREAU OF INVESTIGATION

REPORTING OFFICE <b>NEW ORLEANS</b>	OFFICE OF ORIGIN <b>NEW ORLEANS</b>	DATE <b>6/6/62</b>	INVESTIGATIVE PERIOD <b>9/18/61 - 5/22/62</b>
TITLE OF CASE <b>FREEDOM RIDE 1961 Trailways Bus #P-220 from Montgomery, Alabama to Jackson, Mississippi, 5/24/61; Trailways Bus #218 from Montgomery, Alabama to Jackson, Mississippi, 5/24/61</b>		REPORT MADE BY <b>SA HUNTER E. HELGESON</b>	TYPED BY <b>lrs</b>
		CHARACTER OF CASE  <b>ALL INFORMATION CONTAINED RM; CR HEREIN IS UNCLASSIFIED DATE 11-30-2009 BY 60324 UC BAW/SAB/MJS</b>	

**REFERENCES:**

Report of SA HUNTER E. HELGESON, 9/27/61, at New Orleans.

- C -

**ADMINISTRATIVE:**

An additional copy of this report is designated for the New Orleans Office in the event the Bureau desires to furnish a copy to the United States Attorney, Jackson, Mississippi.

COMMUNICATIONS SECTION  
 JUN 13 1962  
 FBI - MOBILE

APPROVED <i>[Signature]</i>	SPECIAL AGENT IN CHARGE	DO NOT WRITE IN SPACES BELOW	
COPIES MADE: <b>4 - Bureau (157-387)</b> <b>2 - New Orleans (157-264)</b>		<b>157-387-1430</b> JUN 11 1962 DEPT. OF JUSTICE FBI	REC-27 b6 b7C
DISSEMINATION RECORD OF ATTACHED REPORT			
AGENCY	Request Recd.	DATE FWD.	HOW FWD.
BY			

**54 JUN 20 1962**

**UNITED STATES DEPARTMENT OF JUSTICE  
FEDERAL BUREAU OF INVESTIGATION**

ALL INFORMATION CONTAINED  
HEREIN IS UNCLASSIFIED  
DATE 11-30-2009 BY 60324 UC BAW/SAB/MJS

Copy to:

Report of: **SA HUNTER E. HELGESON** Office: **NEW ORLEANS**  
Date: **6/6/62**  
Field Office File No.: **NEW ORLEANS (157-264)** Bureau File No.: **(157-387)**

Title: **FREEDOM RIDE, 1961**  
**Trailways Bus #P-220 from**  
**Montgomery, Alabama to Jackson,**  
**Mississippi, 5/24/61; Trailways**  
**Bus #218 from Montgomery, Alabama to**  
Character: **Jackson, Mississippi, 5/24/61**

Synopsis:

**RACIAL MATTERS; CIVIL RIGHTS**

The following individuals tried and convicted in  
Hinds Co. Court, Jackson Miss on breach of peace charges  
on dates indicated: [redacted] 9/21/61; [redacted]

10/2/61; [redacted] 11/27/61; [redacted]  
[redacted] 12/27/61; [redacted] 12/28/61; [redacted]  
[redacted] 1/16/62; [redacted] 1/24/62; [redacted]

1/24/62. Above individuals sentenced to four months in jail  
and fined \$200. All released on appeal bonds. The following  
individuals entered nolo contendere pleas to breach of peace  
charges in Hinds Co. Court on dates indicated: [redacted]

[redacted] 9/21/61; [redacted] 10/2/61; [redacted]  
10/2/61; [redacted] 10/2/61; [redacted]  
10/9/61; [redacted] 10/9/61; [redacted]  
JR., 10/25/61; [redacted] 1/8/62; [redacted]  
1/22/62; [redacted] 1/22/62 Bond forfeiture ordered for

[redacted] on 9/8/61. [redacted] released from  
custody 11/15/61, upon expiration of sentence. [redacted]  
[redacted] released from custody 11/15/61, upon expiration of  
sentence. [redacted] released from custody 11/22/61, upon  
expiration of sentence and payment of fine.

- C -

**DETAILS:****AT JACKSON, MISSISSIPPI**

On September 18, 1961, City Prosecuting Attorney J.  
A. TRAVIS, JR., City of Jackson, advised that on September 18,  
1961, Attorney [redacted] representing [redacted]  
entered a plea of nolo contendere in Hinds County Court,  
Jackson, Mississippi, to a breach of peace charge on [redacted]

NO 157-264

NO 157-264

behalf. [redacted] was not present. The court sentenced [redacted] to four months in jail, suspended, and fined him \$200. [redacted] paid the \$200 fine on behalf of his client. [redacted] was cited and served in Hinds County Court on a charge of breach of the peace. On September 21, 1961, Mr. TRAVIS advised that on September 21, 1961, [redacted] appeared in Hinds County Court accompanied by his attorney. His attorney announced to the court that a nolo contendere plea had inadvertently entered in Hinds County Court September 18, 1961, in [redacted] behalf and in his absence. The court allowed [redacted] to withdraw the nolo contendere plea. [redacted] then entered a not guilty plea to a charge of breach of the peace. He was tried and convicted by a jury on this charge on September 21, 1961, and was sentenced the same date to four months in jail and fined \$200. He was released the same date on a \$1000 cash appeal bond, plus a \$500 cash costs bond, returnable in Hinds County Circuit Court, Jackson, Mississippi.

b6  
b7c

On October 25, 1961, Mr. TRAVIS advised that [redacted] was tried and convicted in Hinds County Court on a breach of the peace charge on October 25, 1961. He was sentenced to four months in jail and fined \$200. He was released the same date on a \$1000 cash appeal bond, plus a \$500 cash costs bond, returnable in Hinds County Circuit Court.

On January 20, 1962, Assistant City Prosecuting Attorney [redacted] On November 27, 1961, Deputy [redacted] Hinds County Sheriff's Office, advised that on November 27, 1961, [redacted] was tried and convicted in Hinds County Court on a breach of the peace charge. [redacted] was sentenced the same date to four months in jail and fined \$200 and was released the same date on a \$1000 cash appeal bond, plus a \$500 cash costs bond, returnable in Hinds County Circuit Court.

On January 30, 1962, Mr. [redacted] advised that on January 30, 1962, Captain [redacted] Police Department, Jackson, Mississippi, advised that on December 27, 1961, [redacted] was tried and convicted in Hinds County Court on breach of the peace charge. He was sentenced the same date to four months in jail and fined \$200. He was released the same date on \$1000 cash appeal bond, plus a \$500 cash costs bond, returnable in Hinds County Circuit Court.

On May 24, 1962, City Prosecuting Attorney J. A. TRAVIS, JR., advised that he has received information that the transcripts of some of the first James Rider trials in Hinds County Court wherein the defendants had been convicted and appealed, have now been prepared and have been forwarded to the Hinds County Circuit Court. He stated that no dates have yet been set for hearing of these appeals.



NO 157-264

On January 8, 1962, Captain [redacted] Jackson Police Department, advised that on that date attorney [redacted] appeared in Hinds County Court, representing [redacted] [redacted] withdrew a plea of not guilty which had previously been entered by his client to a breach of the peace charge and entered a plea of nolo contendere to this charge on behalf of [redacted] [redacted] was adjudged guilty and sentenced the same date to four months in jail, suspended, and fined \$200, which was paid.

On January 29, 1962, Assistant City Prosecuting Attorney [redacted] advised that on that date [redacted] b6 an attorney representing [redacted] and [redacted] b7C appeared in Hinds County Court and withdrew pleas of not guilty previously entered by his clients to charges of breach of the peace. The attorney entered pleas of nolo contendere to this charge on behalf of his clients. [redacted] and [redacted] was adjudged guilty and sentenced the same date to four months in jail, suspended, and fined \$200, which was paid by the attorney.

On October 9, 1961, [redacted] Hinds County Circuit Clerk's Office, advised [redacted] [redacted] that on October 9, 1961, final bond forfeiture had been ordered on [redacted] after the original order for bond forfeiture had been issued on September 8, 1961.

On November 21, 1961, [redacted] Hinds County Jail, advised that on November 15, 1961, [redacted] [redacted] and [redacted] were released from Hinds County Jail upon expiration of sentence.

On November 22, 1961, Deputy [redacted] Hinds County Sheriff's Office, advised that on November 22, 1961, [redacted] was released from custody in Hinds County Jail upon expiration of jail sentence and payment of balance of fine and costs.



NO 157-264

On September 21, 1961, Mr. TRAVIS advised that on September 21, 1961, Attorney [redacted] appeared in Hinds County Court and withdrew a previously entered not guilty plea on behalf of [redacted] and entered a plea of nolo contendere on [redacted] behalf to a breach of the peace charge. [redacted] was adjudged guilty and sentenced to four months in jail, suspended, and fined \$200. [redacted] paid the \$200 fine for [redacted] who was not present in court.

On October 21, 1961, Mr. TRAVIS advised that an attorney representing the following individuals appeared in Hinds County Court on October 2, 1961, and withdrew previously entered not guilty pleas to breach of peace charges and entered a plea of nolo contendere to this charge on behalf of these individuals. Each was adjudged guilty and sentenced to four months in jail, suspended, and fined \$200. The fine was paid:

[redacted]  
[redacted]  
[redacted]

b6  
b7c

On October 9, 1961, [redacted] Hinds County Circuit Clerk's Office, advised SA [redacted] that on October 9, 1961, Attorney [redacted] appeared in Hinds County Court representing [redacted] and [redacted], who were not present. [redacted] withdrew a previous not guilty plea and entered a plea of nolo contendere to breach of the peace charges on behalf of [redacted] and [redacted]. Each was adjudged guilty and sentenced to four months in jail, suspended, and fined \$200. The fine was paid by [redacted].

On October 25, 1961, Mr. TRAVIS advised that on that date, Attorney [redacted] representing [redacted] appeared in Hinds County Court and on behalf of his client, withdrew a previous not guilty plea to a breach of the peace charge and entered a plea of nolo contendere to the same charge. [redacted] who was not present in court, was adjudged guilty and sentenced the same date to four months in jail, suspended, and fined \$200. The fine was paid.

On January 8, 1962, Captain [redacted] Jackson Police Department, advised that on that date attorney [redacted] appeared in Hinds County Court, representing [redacted] [redacted] withdrew a plea of not guilty which had previously been entered by his client to a breach of the peace charge and entered a plea of nolo contendere to this charge on behalf of [redacted] [redacted] was adjudged guilty and sentenced the same date to four months in jail, suspended, and fined \$200, which was paid.

On January 29, 1962, Assistant City Prosecuting Attorney [redacted] advised that on that date an attorney representing [redacted] and [redacted] appeared in Hinds County Court and withdrew pleas of not guilty previously entered by his clients to charges of breach of the peace. The attorney entered pleas of nolo contendere to this charge on behalf of his clients. [redacted] and [redacted] was adjudged guilty and sentenced the same date to four months in jail, suspended, and fined \$200, which was paid by the attorney.

b6  
b7c

On October 9, 1961, [redacted] Hinds County Circuit Clerk's Office, advised SA [redacted] [redacted] that on October 9, 1961, final bond forfeiture had been ordered on [redacted] after the original order for bond forfeiture had been issued on September 8, 1961.

On November 21, 1961, [redacted] Hinds County Jail, advised that on November 15, 1961, [redacted] [redacted] and [redacted] were released from Hinds County Jail upon expiration of sentence.

On November 22, 1961, Deputy [redacted] Hinds County Sheriff's Office, advised that on November 22, 1961, [redacted] was released from custody in Hinds County Jail upon expiration of jail sentence and payment of balance of fine and costs.

UNITED STATES GOVERNMENT

# Memorandum

ALL INFORMATION CONTAINED  
HEREIN IS UNCLASSIFIED  
DATE 10-20-2009 BY 60324 UC BAW/SAB/MJS

TO : DIRECTOR, FBI (157-387)

DATE: 6/11/62

*JP*  
FROM : SAC, LOUISVILLE (157-89) (RUC)

SUBJECT: FREEBUS

*Freedom Riders - Misc.*

OO: NEW ORLEANS

Re Pittsburgh letter 5/29/62.

Appropriate law enforcement agencies within the Louisville Division were notified in connection with captioned matter pursuant to New Orleans airtel 3/27/62. Included in the law enforcement agencies notified were appropriate representatives of law enforcement agencies in Ashland, Kentucky. It is observed that according to the enclosure with New Orleans airtel 3/16/62 all bus terminals tested in Kentucky resulted in service being afforded to those making the test. No information has been received by the Louisville Division indicating that any trouble has occurred in connection with the matter of integrated bus terminals in Kentucky.

- ② - Bureau (RM)
- 1 - New Orleans (157-264) (RM)
- 1 - Louisville

WLW/mm

(4)

COPIES

*A*

REC-61

157-387-317437

EX-108

FBI  
21H286M71 141M982H12

57 JUN 19 1962

*SKR*

# FEDERAL BUREAU OF INVESTIGATION

REPORTING OFFICE <b>NEW ORLEANS</b>	OFFICE OF ORIGIN <b>NEW ORLEANS</b>	DATE <b>6/5/62</b>	INVESTIGATIVE PERIOD <b>10/12/61 - 5/3/62</b>
TITLE OF CASE <b>FREEDOM RIDE 5/1961 Trailways Bus Montgomery, Alabama to Jackson, Mississippi July 9, 1961</b>		REPORT MADE BY <b>SA HUNTER E. HELGESON</b>	TYPED BY <b>gas</b>
CHARACTER OF CASE ALL INFORMATION CONTAINED HEREIN IS UNCLASSIFIED DATE 11-30-2009 BY 60324 UC BAW/SAB/HJS <b>RM; CR</b>			

REFERENCE

Report of SA HUNTER E. HELGESON, 10/4/62, at New Orleans.

ADMINISTRATIVE

An additional copy of this report is designated for the New Orleans Office in the event the Bureau instructs that a copy be furnished to the U. S. Attorney, Jackson, Mississippi.

CC TO: CSC - VA  
REQ. REC'D 8-12-75  
AUG 28 1975  
ANS.  
BY: MFD/ALH

APPROVED <i>[Signature]</i>	SPECIAL AGENT IN CHARGE <i>Re: Dannah Gifford Manifest</i>	DO NOT WRITE IN THESE SPACES	b6 b7C
COPIES MADE <b>4 Bureau</b> <b>2-New Orleans (157-333)</b>	<b>157-387</b>	<b>18 JUN 11 1962</b>	<b>EX-109</b> <b>REC-22</b>
DISSEMINATION RECORD OF ATTACHED REPORT		NOTATIONS	
AGENCY	REQUEST REC'D	DATE FWD.	HOW FWD.
<i>dept.</i>	<i>[initials]</i>	<i>6-14-62</i>	<i>6-94-62</i>
BY			
<i>[initials]</i>			

EXP-PROC.

UNITED STATES DEPARTMENT OF JUSTICE  
FEDERAL BUREAU OF INVESTIGATION

ALL INFORMATION CONTAINED  
HEREIN IS UNCLASSIFIED  
DATE 11-30-2009 BY 60324 UC BAW/SAB/MJS

Copy to:

Report of: SA HUNTER E. HELGESON  
Date: June 5, 1962

Office: NEW ORLEANS

Field Office File No.: 157-333

Bureau File No.:

Title: FREEDOM RIDE, 1961  
Trailways Bus  
Montgomery, Alabama to  
Jackson, Mississippi,  
July 9, 1961

Character: RACIAL MATTERS; CIVIL RIGHTS

Synopsis:

The following individuals were tried and convicted on breach of the peace charges in Hinds Co. Court, Jackson, Miss. on dates indicated: [redacted] b6 b7C  
[redacted], 10/16/61; [redacted] 5/1/62; [redacted]  
[redacted] 5/1/62. Above individuals sentenced to 4 months in jail and fined \$200. Were released on appeal bonds same date as convicted. Nolo contendere pleas to breach of peace charges entered in behalf of the following individuals in Hinds Co. Court, on dates indicated: [redacted]  
10/9/61; [redacted] 4/2/62; [redacted]  
[redacted] 4/9/62. [redacted], released from Hinds Co. jail, 11/10/61, after expiration sentence and payment of fine. [redacted]  
released from Hinds Co. jail 11/27/61 upon expiration of sentence and payment of balance of fine.

C

DETAILS:

NO 157-333

AT JACKSON, MISSISSIPPI

On October 12, 1961, City Prosecuting Attorney J. A. TRAVIS, JR., City of Jackson, advised that on October 11, 1961, [redacted] was tried in Hinds County Court, Jackson, Mississippi, on a charge of breach of the peace. The court declared a mistrial and ordered a new trial set for October 16, 1961.

On October 16, 1961, City Prosecuting Attorney J. A. TRAVIS, JR., advised SA [redacted] that on October 16, 1961, [redacted] was tried and convicted in Hinds County Court on a charge of breach of the peace. He was sentenced the same date to four months in jail and fined \$200.00. He was released the same date on a \$1,000.00 cash appeal bond plus a \$500.00 cash cost bond, returnable in Hinds County Circuit Court, Jackson, Mississippi.

On May 3, 1962, Captain [redacted] Jackson Police Department, advised that on May 1, 1962, [redacted] and [redacted] were tried and convicted in Hinds County Court on charges of breach of the peace. Both were sentenced the same date to four months in jail and each fined \$200.00. Both were released the same date on \$1,000.00 cash appeal bonds plus \$500.00 cash cost bonds returnable in Hinds County Circuit Court.

On April 9, 1962, City Prosecuting Attorney, J. A. TRAVIS, JR., advised that he had recently received information that the transcripts of some of the first Freedom Rider Trials in Hinds County Court wherein the defendants had been convicted and had appealed have now been prepared and have been forwarded to the Hinds County Circuit Court. He stated that no dates have been set for hearing of these appeals.

NO 157-333

On October 9, 1961, [redacted] Hinds County Circuit Clerk's Office, advised SA [redacted] that on October 9, 1961, Attorney [redacted] appeared in Hinds County Court representing [redacted] who was not present. [redacted] withdrew a plea of not guilty to a breach of the peace charge which had previously been entered by [redacted] and entered a plea of nolo contendere to this charge on behalf of his client. The court then adjudged [redacted] to be guilty and imposed a sentence of four months in jail suspended and a \$200.00 fine which was paid by the attorney.

On April 3, 1962, Captain [redacted] Jackson Police Department advised that on April 2, 1962, an attorney representing [redacted] appeared in Hinds County Court and withdrew a plea of not guilty to a charge of breach of the peace which had previously been entered by [redacted]. The attorney then entered a plea of nolo contendere to this charge on his client's behalf. [redacted] was adjudged guilty and sentenced to four months in jail suspended and fined \$200.00 which fine was paid by the attorney.

On April 9, 1962, City Prosecuting Attorney J. A. TRAVIS, JR., advised that on April 9, 1962, [redacted] through his attorney withdrew a plea of not guilty to a breach of the peace charge and entered a plea of nolo contendere to this charge in Hinds County Court. [redacted] was adjudged guilty and sentenced the same date to four months in jail suspended and fined \$200.00, paid.

On November 16, 1961, [redacted] Hinds County Sheriff's Office, advised that on November 10, 1961, [redacted] was released from Hinds County jail after expiration of sentence and payment of \$200.00 fine.



NO 157-333

On November 27, 1961, Deputy [redacted] Hinds  
County Sheriff's Office, advised that on November 27, 1961,  
[redacted] was released from custody in the Hinds  
County Jail upon expiration of jail sentence and payment of  
balance of fine and costs.

b6  
b7C

F B I

Date: 6/12/62

PLAIN TEXT

Transmit the following in \_\_\_\_\_  
(Type in plain text or code)

Via AIRTEL AIRMAIL  
(Priority or Method of Mailing)

TO: DIRECTOR, FBI (157-387)

FROM: SAC, NEW ORLEANS (157-358)

RE: *Freedom Riders Miscellaneous*  
FREEDOM RIDE, 1961  
Greyhound Bus, Nashville, Tennessee,  
to Jackson, Mississippi, 7/29/61  
RM; CR

Rerep SA HUNTER E. HELGESON, 6/6/62, at New Orleans.

*mz*  
The name of one of the Freedom Riders, [redacted]  
is misspelled as [redacted] in line 4 of synopsis and in  
last line page 1.

b6  
b7C

Please make necessary corrections in Bureau copies.  
New Orleans copies corrected.

3 - Bureau  
1 - New Orleans

HEH/ush  
(4)

*157-387-*  
NOT RECORDED  
12 JUN 14 1962

*350*  
57 JUN 22 1962

*SWIFT*  
CONSCIOUS/DATION

Approved: *HEH*  
Special Agent in Charge

Sent \_\_\_\_\_ M Per \_\_\_\_\_

UNITED STATES GOVERNMENT

# Memorandum

TO : DIRECTOR, FBI

DATE: 6/22/62

FROM: SAC, NEW ORLEANS (157-386) (P)

SUBJECT: FREEDOM RIDE - 101150  
1961 Trailways  
Bus No. P224, Los Angeles,  
California, to Jackson,  
Mississippi, September 9, 1961  
RM; CR  
(OO: New Orleans)

Re New Orleans letter to Bureau dated 4/17/62.

On June 14, 1962, [redacted]  
[redacted] First Judicial District Court, Caddo Parish, Shreveport,  
Louisiana, advised his files indicate no further court action  
has resulted with reference to charges against [redacted]  
[redacted] and [redacted]

b6  
b7C

This matter will be followed and the Bureau appropri-  
ately advised.

LEAD

NEW ORLEANS DIVISION

AT SHREVEPORT, LOUISIANA:

[redacted] Will follow and report State charges against  
[redacted] and [redacted]

- 2 - Bureau
- 2 - New Orleans

DC/tal  
(4)

EXP. PROC.

9

REC-32

DEPT. OF JUSTICE  
JUL 16 1962

MAILED 3 1962

1433

1962

374

68 JUL 2 1962

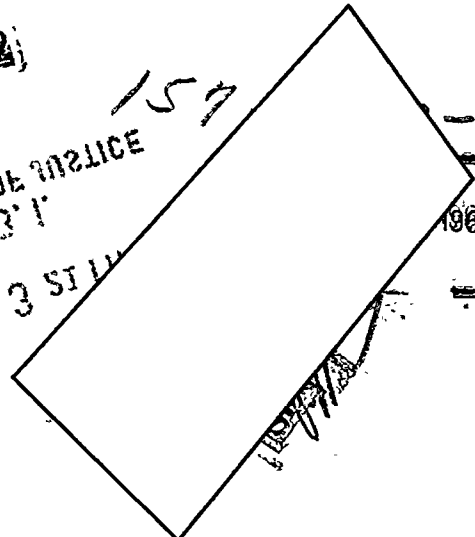

UNITED STATES GOVERNMENT

# Memorandum

ALL INFORMATION CONTAINED  
HEREIN IS UNCLASSIFIED  
DATE 11-30-2009 BY 60324 UC BAW/SAB/MJS

TO : DIRECTOR, FBI (~~44-17831~~)

DATE: 6/27/62

*mk*  
FROM : SAC, WFO (147-133) (RUC)

SUBJECT: FREEDOM RIDE/S 1961  
TRAILWAYS BUS  
SHREVEPORT, LOUISIANA TO  
JACKSON, MISSISSIPPI  
8/4/61  
(OO:NO)

Re WFO "RUC" letter to Bureau dated 6/6/62.

Since the date of referenced letter a petition for a Rehearing was filed in the U. S. Supreme Court (USSC) in the case entitled Levert H. Taylor, Et Al vs. Louisiana, Case Number 773 Appellate, October Term, 1961.

By Order List handed down on 6/25/62, the USSC denied the petition for a Rehearing in this case.

In view of the above, this case remains in an "RUC" status in the WFO.

- 2 - Bureau
- 1 - New Orleans (157-363)
- 1 - WFO

RCV:lrs  
(4)

REC-46

157-387-1434

JUN 27 1962

EX-134

JUL 3

1962 WJG

F B I

Date: 7/9/62

Transmit the following in \_\_\_\_\_  
(Type in plain text or code)

Via AIRTEL AIR MAIL  
(Priority or Method of Mailing)

TO: DIRECTOR, FBI (157-387)

FROM: SAC, JACKSONVILLE (157-250) (P)

SUBJECT: "FREEBUS"  
RM

*Freedom Riders - Misc.*

CORE  
RM

Re Jacksonville airtel to Bureau, 6/6/62.

Records, Clerk's Office, Marion County Circuit Court, Ocala, Fla., as checked 7/6/62, reflect Circuit Judge D. R. SMITH scheduled hearing for 7/6/62, to hear argument on motion of State Attorney [redacted] to dismiss appeals of convictions of three Freedom Riders, [redacted]

b6  
b7C

[redacted] AND [redacted] however, State Attorney [redacted] requested a postponement until after 8/1/62, which was granted; however, exact date was not set.

Jacksonville will follow this matter closely; the Bureau will be advised of all future pertinent developments, and letterhead memorandum will be submitted concerning results of above hearing when known.

*K*

REC-59 157-387-1435

5 JUL 11 1962

- 3 - Bureau (RM)
- 4 - Jacksonville (1 - 105-66)
- (1 - 105-82)

EX-116

RHA-cla  
(7)

C. C. Wick

*[Handwritten signature]*

Approved: \_\_\_\_\_ Sent \_\_\_\_\_ M Per \_\_\_\_\_

54 JUL 18 1962  
Special Agent in Charge

UNITED STATES GOVERNMENT

# Memorandum

ALL INFORMATION CONTAINED  
HEREIN IS UNCLASSIFIED  
DATE 11-30-2009 BY 60324 UC BAW/SAB/MJS

TO : DIRECTOR, FBI (157-387)

DATE: 7/31/62

FROM : SAC, NEW ORLEANS (157-264)(P)

SUBJECT: *Freedom Riders - MIS Cell & News*  
FREEBUS

OO: NEW ORLEANS

*W*  
[redacted] head of the Congress of Racial Equality (CORE), New Orleans, Louisiana, advised on July 10, 1962, that she was not aware of any present plans of CORE to resume the captioned activity.

*LA*  
b6  
b7C

This matter will be followed with [redacted] and the Bureau will be advised.

- 2 - Bureau (RM)
  - 3 - New Orleans (2-157-264; 1-137-1840)
- JEP/jp  
(5)

EX-100

*S*

REG-1 157-387-1436

AUG 5 1962  
McBOWEN  
REC'D - CIV RIGHTS

57 AUG 8 1962

F B I

Date: 8/1/62

7/5

Transmit the following in PLAIN TEXT  
(Type in plain text or code)

Via AIRTEL AIR MAIL  
(Priority or Method of Mailing)

TO: DIRECTOR, FBI  
FROM: (W) SAC, MEMPHIS (157-162) (P)

SUBJECT: RACIAL SITUATION IN MISSISSIPPI  
SIT DOWN, ILLINOIS CENTRAL RAILROAD STATION  
CLARKSDALE, MISSISSIPPI  
RM OF FREEDOM RIDERS - MISCELLANEOUS

157-387-1425  
Re Memphis airtel to Bureau 5/21/62.

Attached are 8 copies of a letterhead memorandum concerning captioned matter.

The information set forth in the letterhead memorandum was furnished to SA [redacted] b6 b7C

Inasmuch as the next term of Circuit Court will convene at Clarksdale, Mississippi, the second Monday of January, 1963, this case is being placed in a Pending Inactive status.

In the event there are additional developments in this connection, the Bureau will be advised.

CC - WicR

3 - Bureau (Encls. 8) ENCLOSURE  
1 - Memphis

TSH:cjr  
(4)

Agency G-2, ONI, OSI, CRD

Date Forw. 8/1/62

How Forw. R/S

By RBL/pear

1 cc org unit  
2cc destroyed EX 101

REC-20 157-387-1437

15 AUG 3 1962

Airtel.....

Teletype.....

A. M.....

A. M. S. D.....

Spec. Del.....

Reg. Mail.....

Registered.....

Approved: 51 AUG 13 1962 Special Agent in Charge

Sent \_\_\_\_\_ M Per \_\_\_\_\_

[Handwritten signature]





UNITED STATES DEPARTMENT OF JUSTICE

FEDERAL BUREAU OF INVESTIGATION

In Reply, Please Refer to  
File No. 157-162

Memphis, Tennessee  
August 1, 1962

RE: RACIAL SITUATION IN MISSISSIPPI  
SIT DOWN, ILLINOIS CENTRAL RAILROAD STATION  
CLARKSDALE, MISSISSIPPI  
RACIAL MATTERS

On July 30, 1962, Circuit Court Clerk, [redacted] Clarksdale, Mississippi, advised that Circuit Court adjourned at Clarksdale as of July 27, 1962. [redacted] stated his records indicate on July 25, 1962, Circuit Judge Edward Green directed that the appeals of [redacted] and [redacted] be continued until the next term of court which convenes the second Monday of January, 1963. [redacted] informed no action whatsoever regarding this case was taken during the recent term of Circuit Court.

b6  
b7C

MISS

This document contains neither recommendations nor conclusions of the FBI. It is the property of the FBI and is loaned to your agency; it and its contents are not to be distributed outside your agency.

157-387-1437  
ENCLOSURE

UNITED STATES GOVERNMENT

# Memorandum

ALL INFORMATION CONTAINED  
HEREIN IS UNCLASSIFIED  
DATE 11-30-2009 BY 60324 UC BAW/SAB/MJS

TO : DIRECTOR, FBI

DATE: 8/6/62

*From*

FROM : SAC, NEW ORLEANS (157-386) (P)

*Freedom Riders - Miscellaneous*

SUBJECT: FREEDOM RIDE, 1961 Trailways  
Bus No. P224, Los Angeles,  
California to Jackson,  
Mississippi, 9/9/61  
RM; CR  
(OO: New Orleans)

*From  
3/5  
2/7*

Remylet, 6/22/62.

*may  
2/3*

On 8/3/62 [redacted]  
First Judicial District Court, Caddo Parish, Shreveport,  
La., advised his files indicated no further court action  
has resulted from charges against [redacted] and  
[redacted]

The matter will be followed and Bureau appropriately  
advised.

- 2 - Bureau
- 2 - New Orleans

DC:lil  
(4)

EX-102

b6  
b7c

37

EX-102

157-387-38

12 AUG 9 1962

REC-53

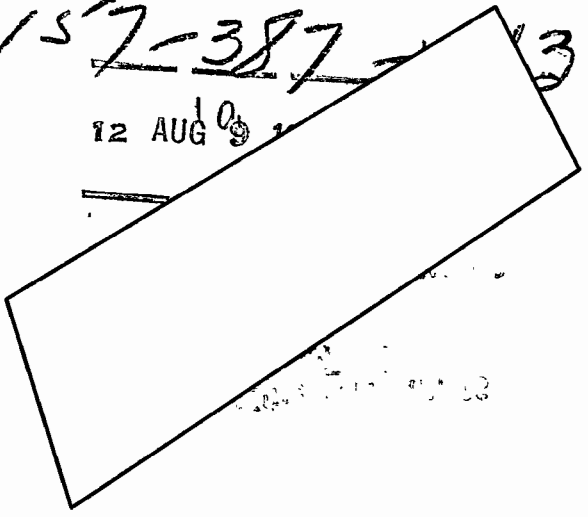

*Call  
KJB*

57 AUG 21 1962

FBI

Date: 8/10/62

Transmit the following in \_\_\_\_\_  
(Type in plain text or code)

Via AIRTEL AIRMAIL  
(Priority or Method of Mailing)

TO: DIRECTOR, FBI (157-387)  
FROM: SAC, JACKSONVILLE (157-250)  
SUBJECT: "FREEBUS"  
RM  
  
CORE  
RM

Re Jacksonville airtel to Bureau, 7/9/62.

On 8/6/62, Circuit Judge, D. R. SMITH, Fifth  
Judicial District, Ocala, Fla., granted ten days to [redacted]  
[redacted] Jacksonville Attorney, representing three  
"Freedom Riders," arrested in Ocala, Fla., in June, 1961,  
in which to prepare arguments as to why a state motion to  
dismiss his appeal of the conviction should not be granted.

b6  
b7c

The three riders, [redacted] [redacted]  
[redacted], and [redacted] were convicted in Marion  
County Court, Ocala, Fla., in 8/61 on charges of "Unlawful  
Assembly."

Jacksonville will follow this matter closely and  
the Bureau will be advised of all future developments.

CC: Wick

EX-113

REC-23

157-387-1439

- 3 - Bureau (RM)
- 4 - Jacksonville  
(1 - 105-66)  
(1 - 105-82)

TRT-ssp

XEROX  
AUG 14 1962

AUG 13 1962

Handwritten initials/signature

Approved: [Signature] Special Agent in Charge

Sent \_\_\_\_\_ M Per \_\_\_\_\_

56 AUG 14 1962

UNRECORDED COPY FILED IN 100-225-892

UNITED STATES GOVERNMENT

# Memorandum

ALL INFORMATION CONTAINED  
HEREIN IS UNCLASSIFIED  
DATE 11-30-2001 BY 60324 UC BAW/SAB/MJS

*3/20/62*  
**REC-61**

Mr. Tolson	✓
Mr. Belmont	✓
Mr. Mohr	✓
Mr. Callahan	✓
Mr. Conrad	✓
Mr. DeLoach	✓
Mr. Malone	✓
Mr. Rosen	✓
Mr. Sullivan	✓
Mr. Tavel	✓
Mr. Trotter	✓
Tele. Room	✓
Miss Holmes	✓
Miss Gandy	✓

TO : DIRECTOR, FBI  
F. W. W. 8-14-62 *JH*  
ERROR LETTER SENT  
FROM : SAC, LOS ANGELES (62- New )

*PMB*

*0* FREEDOM RIDERS - MISCELLANEOUS  
SUBJECT: [REDACTED]  
INFORMATION CONCERNING

*2*

On August 3, 1962, [REDACTED] California, telephonically contacted the Santa Ana Resident Agency, and inquired as to why the F.B.I. had objection to [REDACTED] making a trip to Washington, D. C., and from there down through the South. He continued, that [REDACTED] was interested in making such a trip for purely travel purposes and is not interested in the racial problems of other problems of the South. He said that [REDACTED] at the World Travel Bureau, 618 North Main Street, Santa Ana, had told [REDACTED] that he should not make such a trip because the F.B.I. might think he was a Freedom Rider, and the F.B.I. would not approve of such a trip.

b6  
b7C

[REDACTED] said [REDACTED] is not a trouble-maker and is not looking for trouble, but he would like to know whether it is all right for [REDACTED] to make such a trip. He said if the F.B.I. does not want the boy to make the trip, he will not go, but otherwise he intends to make the trip.

[REDACTED] was advised that the F.B.I. has nothing to say as to whether [REDACTED] does or does not make the trip. He was further advised that the travel agent was in no way authorized to inject the F.B.I. into the problem and that the alleged comments by the travel agent were completely in error. He was told the decision whether [REDACTED] did or did not make the trip is entirely up to his son and to him, and that the F.B.I. has no thought of injecting itself into this decision. He was further told that the F.B.I. has nothing to do with regulating travel and that any statement to the contrary is erroneous and false.

EX-110  
PROC.

32

2 - Bureau  
1 - Los Angeles

EJK:jab  
(3)

**SENT DIRECTOR**  
8-14-62

**REC-61**

157-387-144  
AUG 14 1962  
RECEIVED DIRECTOR

*12*

*F4*

AUG 29 1962

CRIME RESEARCH

[redacted] World Travel Agency, 618 North Main Street, Santa Ana, California, advised SAs [redacted] and [redacted] on August 3, 1962, the World Travel Agency is in the business of selling transportation and no one is authorized to enter any objection to anyone making a trip. She advised she never heard of any employee under her supervision trying to dissuade any potential traveler from buying transportation, particularly by reference to the F.B.I. She advised it is her desire this matter be corrected as soon as possible.

[redacted] World Travel Agency, advised SAs [redacted] and [redacted] on August 3, 1962, that [redacted] has been attempting to arrange a tour for himself and [redacted]. This tour is to Washington, D. C., and on down through the South. He continued in his conversations with [redacted] he learned [redacted] is very interested in the racial situation in the South and wants to make a firsthand study of it. He continued he personally has lived in the South and he could tell from [redacted] attitude that [redacted] would be looked upon as a Freedom Rider in the South, and because of this attitude, would likely get into trouble. [redacted] continued the parents of [redacted] boy had requested him to try to dissuade [redacted] and [redacted] from making the trip as they felt that [redacted] might get into trouble on the trip.

B. APPROX. 1945

CALIF.

b6  
b7c

[redacted] said he told [redacted] he felt that he should not make the trip because he would be looked upon in the South as a Freedom Rider, and the F.B.I. would probably object to him making the trip. He said this was a matter of opinion on his part and he gave it to [redacted] only as a matter of opinion in his effort to convince [redacted] he should not make the trip. [redacted] said his opinion was based on what he considered the role of the F.B.I. should be.

The investigative responsibilities of the F.B.I were outlined to [redacted]. He was instructed that neither he nor anyone else not employed by the F.B.I. or in official position is empowered to speak for the F.B.I. and that further action of this sort on his part will not be tolerated.

[redacted] said he is very sorry that he told [redacted] what he did. He said he was motivated by a sincere desire to keep [redacted] out of trouble, and by a desire to help further trouble from coming about in the South. [redacted] said he regrettably had not understood the function of the F.B.I., and he realized he erred in using the name of the F.B.I. or in making reference to the F.B.I. under the circumstances.

LA 62-

[redacted] said he will not again make such a statement.

[redacted] furnished the following background and descriptive data concerning himself:

Name	[redacted]
Race	[redacted]
Sex	Male
Birth data	[redacted]
Height	[redacted]
Weight	[redacted]
Hair	[redacted]
Eyes	[redacted]
Marital Status	[redacted]
Citizenship	[redacted]
Alien Registration No.	[redacted]
Arrest Record	None admitted
Residence	[redacted] <u>California.</u>

b6  
b7C

No further action is being taken by Los Angeles.

F B I

Date: 8/24/62

Transmit the following in AIRTEL

(Type in plain text or code)

AIRMAIL

Via \_\_\_\_\_

(Priority or Method of Mailing)

TO: DIRECTOR, FBI (157-387)  
FROM: SAC, JACKSONVILLE (157-250)  
RE: "FREEBUS"  
RM  
CORE  
RM

Freedom Riders - Misc

Re JK airtel to Bureau 8/10/62.

*ALL FBI*

On 8/22/62, Circuit Judge D. R. SMITH, 5th Judicial Circuit, Ocala, Fla., dismissed an appeal filed in Circuit Court from a County Court conviction of "Unlawful Assembly" involving three "Freedom Riders." [redacted] and [redacted] convicted in August, 1961.

b6  
b7c

Action by Judge SMITH came after [redacted] Negro Attorney, failed to present new arguments as to why the appeal should be upheld. [redacted] had been given ten days in which to present new arguments against a dismissal motion filed by State Attorney [redacted]

With the appeal motion dismissed, the three "Freedom Riders" face payment of fines or jail sentences.

[redacted] was previously fined \$500 or 6 months and an additional 30 days in jail.

[redacted] was fined \$250 or 90 days in jail.

[redacted] was fined \$500 or 6 months in jail.

*157-387-1441*

3-Bureau (RM)  
4-Jacksonville (1- 105-66)  
TRT:beh (1- 105-82)  
(7)

REC-64

11 AUG 28 1962

C. C. Wick  
Approved: \_\_\_\_\_

*TRT*  
*beh*

Special Agent in Charge

56 SEP 5 1962

M Per \_\_\_\_\_

*101*



JK 157-250

On 8/23/62, Marion County Prosecutor [redacted] [redacted] announced he plans to put the three "Freedom Riders" on trial on 9/25/62 in County Court on second charges of "failure to obey an officer." This action on the part of the prosecutor came after Judge SMITH signed an order dismissing an appeal by the "Freedom Riders" on 8/22/62, appealing their previous conviction in County Court of "Unlawful Assembly."

b6  
b7c

Jacksonville will follow this matter closely and the Bureau will be advised of all future developments.

ALL INFORMATION CONTAINED  
HEREIN IS UNCLASSIFIED  
DATE 11-17-2009 BY 60324 UC BAW/SAB/MJS

F B I

Date: 9/21/62

Transmit the following in \_\_\_\_\_  
(Type in plain text or code)

Via AIRTEL AIR MAIL  
(Priority or Method of Mailing)

TO: DIRECTOR, FBI (157-387)  
FROM: SAC, JACKSONVILLE (157-250) (P)  
SUBJECT: "FREEBUS"  
RM  
FREEDOM RIDERS MISCELLANEOUS  
CORE  
RM

Remyairtel 9/14/62.

Records, Clerk's Office, Marion County Circuit Court, Ocala, Fla., as checked on 9/20/62, reflect the motion for rehearing filed by defendant's attorney, [redacted] on 9/10/62, was denied by Judge D. R. SMITH on 9/20/62.

b6  
b7c

Jacksonville will follow this matter closely. The Bureau will be advised of all future pertinent developments, and letterhead memorandum will be submitted concerning final disposition when known.

C. G. Wick

3 - Bureau (RM)  
4 - Jacksonville  
(1 - 105-66)  
(1 - 105-82)  
RHA-bag  
(7)

REC-38

EX-100

157-387-4413

SEP 24 1962

[Handwritten signature]

Approved: [Signature] Special Agent in Charge

Sent \_\_\_\_\_ M Per \_\_\_\_\_

58 SEP 25 1962

*MA*

F B I

Date: 9/14/62

Transmit the following in \_\_\_\_\_  
(Type in plain text or code)

Via AIRTEL AIRMAIL  
(Priority or Method of Mailing)

TO: DIRECTOR, FBI (157-387)  
FROM: SAC, JACKSONVILLE (157-250) (P)  
SUBJECT: "FREEBUS"  
RM

CORE  
RM

Remyairtel, 8/24/62.

Records, Clerk's Office, Marion County Circuit Court, Ocala, Florida, as checked on 9/12/62, reflect defendant's attorney, [redacted] on 9/10/62, filed a petition for rehearing, for which no date has been set.

b6  
b7C

Jacksonville will follow this matter closely; the Bureau will be advised of all future pertinent developments, and letterhead memorandum will be submitted concerning results of above hearing when known.

- ③ - Bureau (RM)
- 4 - Jacksonville  
(1 - 105-66)  
(1 - 105-82)

RHA-jeh  
(7)

REC-52

EX-108

157-387-1442

SEP 15 1962

STAMP

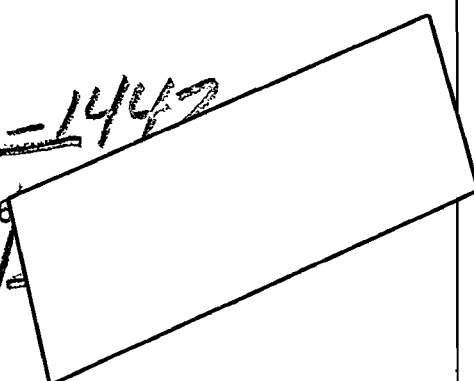

57 SEP 20 1962

Approved: \_\_\_\_\_ Sent \_\_\_\_\_ M Per \_\_\_\_\_

Special Agent in Charge

UNITED STATES GOVERNMENT

# Memorandum

TO : DIRECTOR, FBI

DATE: September 21, 1962

FROM : SAC, NEW ORLEANS (157-386) (P)

SUBJECT: FREEDOM RIDE <sup>MISC.</sup> 1961 Trailways  
Bus No. P224, Los Angeles,  
California to Jackson,  
Mississippi, 9/9/61  
RM; CR  
(OO: NEW ORLEANS)

Remylet 8/6/62.

On September 17, 1962, [redacted] b6  
[redacted] First Judicial District Court, Caddo Parish, Shreveport, b7C  
Louisiana, advised his files indicate no further court action with  
reference to charges against [redacted] and [redacted]

THE NEW ORLEANS DIVISION

AT SHREVEPORT, LOUISIANA

[redacted] Will follow and report state charges against [redacted] and [redacted]

2-Bureau  
2-New Orleans

DC/dr

(4)

*gem*

REC-8  
EX-113  
32

157-387-1444

[redacted]

b6  
b7C

50 OCT 1 1962  
161

UNITED STATES GOVERNMENT

# Memorandum

TO : DIRECTOR, FBI (157-387)

DATE: 9/30/62

FROM : *[Handwritten Signature]* SAC, NEW ORLEANS (157-264) (P)

SUBJECT: FREEBUS  
OO: NEW ORLEANS

Freedom Riders - Misc

On 9/30/62,  head of the New Orleans chapter of the Congress of Racial Equality (CORE), advised that CORE has no plans at the present time to resume the captioned activity.

b2  
b6  
b7C  
b7D

This matter will be followed with  and the Bureau will be advised.

2 - Bureau (RM)  
3 - New Orleans (2: 157-264; )  
JEP/jp  
(5)

5

U.S. DEPARTMENT OF JUSTICE

REC-55

157-387-1445

11 OCT 3 1962

50 OCT 8 1962

*[Handwritten Signature]*

F B I

Date: 9/28/62

Transmit the following in \_\_\_\_\_  
(Type in plain text or code)

Via AIRTEL AIRMAIL  
(Priority or Method of Mailing)

TO: DIRECTOR, FBI (157-387)  
FROM: SAC, JACKSONVILLE (157-250) (P)  
SUBJECT: "FREEBUS" *Freedom Riders - 11/1/62*  
RACIAL MATTERS  
CORE  
RACIAL MATTERS

Re my airtel 9/14/62.

Enclosed herewith are appropriate copies of  
letterhead memorandum reflecting results of most recent  
court action in Ocala, Fla., against Freedom Riders,  
[redacted] and  
[redacted]

Jacksonville will follow this matter closely;  
this matter will be advised of all future pertinent  
developments, and letterhead memorandum will be submitted  
concerning outcome of court trial when known.

b6  
b7c

ENCLOSURE

- ③ - Bureau (Enc. 8) (RM)
- 4 - Jacksonville (1 - 105-66)  
(1 - 105-82)

RHA:jeh  
(7) Agency G-2, ONI, OSI, CRD

Date Forw... 10-3-62

How Forw... RS

By... RBL:jeh

G.C. Wick

*1 cc org unit  
2 cc's destroyed*

REC-60

*157-392-1446*



OCT 2 1962

Approved: *[Signature]*  
Special Agent in Charge

Sent \_\_\_\_\_ M Per \_\_\_\_\_

3 OCT 9 1962



UNITED STATES DEPARTMENT OF JUSTICE

FEDERAL BUREAU OF INVESTIGATION

Jacksonville, Florida  
September 28, 1962

In Reply, Please Refer to  
File No.

**"FREEDOM RIDERS"  
(SECTION TWO, PROFESSIONAL GROUP)**

Records, Clerk's Office, Marion County Circuit  
Court, Ocala, Florida, as checked on September 28, 1962,  
reflects Freedom Riders [redacted]

[redacted] and [redacted] were granted a stay  
of execution of sentences on charge of "unlawful assembly"  
by Judge D. R. Smith, Marion County Circuit Court, on  
September 26, 1962. They had previously been sentenced on  
above charges as follows:

[redacted] - 6 months sentence plus \$300 fine, or  
an additional 6 months in jail.

[redacted] - 90 days in jail or \$250.

[redacted] - 30 days sentence plus fine of \$500  
or 6 months.

The stay of execution of sentence was granted on  
the basis that [redacted] Attorney for defendents,  
intended to petition for a "Writ of Certiorari" before the  
Florida Supreme Court for the District Court of Appeal.

Records of Clerk's Office, Marion County Circuit  
Court, Ocala, Florida, as checked on September 28, 1962,  
reflects subjects [redacted] and [redacted] appeared before Judge  
Lewis O. Myers, Jr., on September 28, 1962, on charge of  
failing to obey a lawful order of a police officer. [redacted] was  
not present and was reported ill in New York.

On September 28, 1962, Judge Myers, after learning  
of the decision of Judge D. R. Smith, Marion County Circuit  
Court, who granted a stay of execution of sentence, on an  
unlawful assembly charge, ruled the charges currently pending  
against above individuals in his court would not be granted  
until next term of court, presently scheduled for November, 1962.

157-387-1446

ENCLOSURE

b6  
b7c



**"FREEDOM RIDERS"  
(SECTION TWO, PROFESSIONAL GROUP)**

The above individuals were released under \$1,000 bond each on September 28, 1962.

This document contains neither recommendations nor conclusions of the FBI. It is the property of the FBI and is loaned to your agency; it and its contents are not to be distributed outside your agency.

UNITED STATES GOVERNMENT

# Memorandum

TO : DIRECTOR, FBI (157-387)

DATE: 11/5/62

FROM : SAC, NEW ORLEANS (157-386) (P)

SUBJECT: FREEDOM RIDE, 1961 Trailways  
Bus No. P224, Los Angeles,  
California to Jackson,  
Mississippi, 9/9/61  
RM; CR  
(OO: NEW ORLEANS)

Remylet 9/21/62.

On October 29, 1962, [redacted]  
[redacted] First Judicial District Court, Caddo  
Parish, Shreveport, Louisiana, advised his files  
indicate no further court action with reference to  
charges against [redacted] and [redacted]

LEAD

NEW ORLEANS

AT SHREVEPORT, LOUISIANA

[redacted] Will follow and report state charges against  
[redacted] and [redacted]

- ② - Bureau
- 2 - New Orleans

DC:mam  
(4)

REC-38

U.S. DEPT. OF JUSTICE  
F. B. I.  
EX 109  
NOV 5 1962  
RECEIVED  
FBI - NEW ORLEANS

50 NOV 13 1962

157-386-449

[Large diagonal redaction box]

b6  
b7c

*m*  
9/5

F B I

Date: 11/9/62

b6  
b7c

Transmit the following in \_\_\_\_\_  
(Type in plain text or code)

Via AIRTEL AIRMAIL  
(Priority or Method of Mailing)

TO: DIRECTOR, FBI (157-387)  
FROM: SAC, JACKSONVILLE (157-250) (P)  
SUBJECT: "FREEBUS" FREEDOM RIDERS - MISC  
RM  
CORE  
RM

Re Jacksonville airtel, 9/28/62.

Records, Clerk's Office, Marion County Circuit Court, Ocala, Florida, as checked on 11/7/62 reflect defendant's attorney, [redacted] on 10/10/62, filed notice of intention to petition for a "Writ of Certiorari" before the Fla. Supreme Court of the District Court of Appeals concerning sentences received by defendants before Judge D. R. SMITH, Marion County Circuit Court, Ocala, Florida, in 1961.

b6  
b7c

Jacksonville will follow this matter closely.

The Bureau will be advised of all future pertinent developments and a letterhead memorandum will be submitted concerning these developments when known.

- 3 - Bureau (RM)
- 4 - Jacksonville *EX-103*
  - (1 - 105-66)
  - (1 - 105-82)

REC-22

157-387-1448

13 NOV 10 1962

RHA-ssp

(7)

C C - Wick

58 NOV 19 1962

XEROX  
NOV 14 1962

*[Handwritten signature]*

Approved: *[Signature]* Sent \_\_\_\_\_ M Per \_\_\_\_\_  
Special Agent in Charge

157-387-225892

UNITED STATES GOVERNMENT

# Memorandum

ALL INFORMATION CONTAINED  
HEREIN IS UNCLASSIFIED  
DATE 11-30-2009 BY 60324 UC BAW/SAB/MJS

TO : DIRECTOR, FBI (157-387)

DATE: 11/26/62

FROM : SAC, NEW ORLEANS (157-264) (P)

*Freedom Riders - Misc.*

SUBJECT: FREEBUS  
(OO: New Orleans)

*Case*  
On 11/21/62 [redacted] who is head of the New Orleans Chapter of the Congress of Racial Equality (CORE), stated that CORE has no plans at present to resume the captioned activity.

This matter will be followed with [redacted] and the Bureau will be advised.

b2  
b6  
b7C  
b7D

- ② - Bureau (RM)
- 3 - New Orleans (2 - 157-264)
- (1 - [redacted])

JEP:lil  
(5)

*C*

53 DEC 4 1962 <sup>242</sup>

EX-116

REC-42

157-387-1119

4 NOV 28 1962

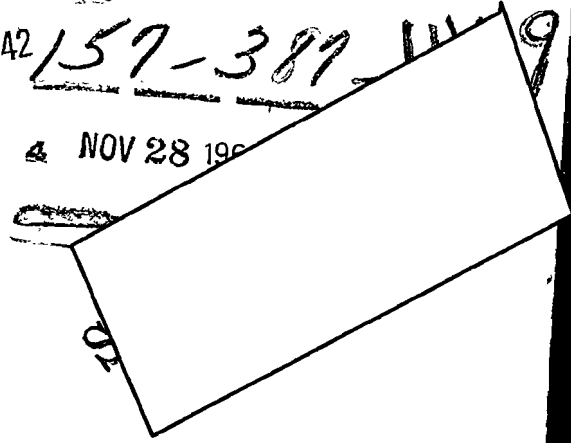

UNITED STATES GOVERNMENT

# Memorandum

TO : DIRECTOR, FBI (157-387)

DATE: December 12, 1962

FROM : *[Handwritten initials]* SAC, NEW ORLEANS (157-386) - P -

SUBJECT: FREEDOM RIDE 1961  
Trailways Bus No. P224,  
Los Angeles, California, to  
Jackson, Mississippi, 9/9/61  
RM; CR  
OO: NO

Remylet November 5, 1962.

On December 10, 1962, [redacted]  
[redacted] First Judicial District Court, Caddo  
Parish, Shreveport, La., advised his files indicate no  
further court action with reference to charges against  
[redacted] and [redacted]

b6  
b7c

New Orleans at Shreveport, La. Will follow  
and report state charges against [redacted] and [redacted]

- 2 - Bureau
- 2 - New Orleans

DC/jao  
(4)

REC-41

157-387-1450

DEC 11 1962

EX-105

REC'D - [redacted]

DEC 12 1962

REC-1

137

DEC 19 1962

*[Handwritten mark]*

*[Handwritten mark]*

[Large redacted area]

F B I

Date: 12/20/62

Transmit the following in \_\_\_\_\_  
(Type in plain text or code)

Via AIRTEL AIR MAIL  
(Priority or Method of Mailing)

*Ma*  
*250*  
*12-20-62*  
*W...*

TO: DIRECTOR, FBI (157-387)  
FROM: SAC, JACKSONVILLE (157-250) (P)  
SUBJECT: "FREEBUS" <sup>0</sup> FREEDOM RIDERS, 196  
RM

CORE  
RM

Remyairtel, 11/9/62.

Enclosed herewith are appropriate copies of letterhead memorandum reflecting results of court action in Ocala, Florida against Freedom Riders [redacted] and [redacted]

JACKSONVILLE

At Tallahassee, Florida:

Will check records of Clerk's Office, District Court of Appeals, First District, State of Florida, to determine whether defendants' attorney, [redacted] has filed petition for "Writ of Certiorari" and will closely follow this matter and report all future developments.

The Bureau will be advised of all future pertinent developments, and a letterhead memorandum will be submitted concerning these developments when known.

- 3 - Bureau (Enc 8) (RM)
- 4 - Jacksonville (1- 105-66) (1- 105-82)

5 BHA:ega  
(MAN) 3  
1963

EX-120  
157-387-1451  
Date Forw. 12/27/62  
How Forw. [unclear]  
By Rbl:ph  
10/20/62  
2003 destroyed

WICK

Approved: \_\_\_\_\_ Sent \_\_\_\_\_ M Per \_\_\_\_\_  
Special Agent in Charge

b6  
b7c

7M



UNITED STATES DEPARTMENT OF JUSTICE

FEDERAL BUREAU OF INVESTIGATION

In Reply, Please Refer to  
File No.

Jacksonville, Florida  
December 20, 1962

"FREEDOM RIDERS"  
(SECTION TWO, PROFESSIONAL GROUP)

*ALL FLA*

Records, Clerk's Office, Marion County Circuit Court, Ocala, Florida, as checked on November 7, 1962, reflected Attorney [redacted] for Freedom Riders [redacted]

[redacted] and [redacted] on October 10, 1962, filed notice of intention to petition for a "Writ of Certiorari" before either the Florida Supreme Court or the appropriate District Court of Appeals, for a review of decision and judgment rendered against the defendants in Marion County Judges Court, Ocala, Florida.

b6  
b7C

Records of the above office, as checked on December 19, 1962, reflected Attorney [redacted] had filed notice of intention to apply to the District Court of Appeals, First District, State of Florida, Tallahassee, Florida, for "Writ of Certiorari" for court to review decision and judgment of Marion County Circuit Court, Ocala, Florida.

This document contains neither recommendations nor conclusions of the FBI. It is the property of the FBI and is loaned to your agency; it and its contents are not to be distributed outside your agency.

ENCLOSURE

157-387-1451



UNITED STATES GOVERNMENT

# Memorandum

TO : DIRECTOR, FBI (157-387)

DATE: 1/25/63

*Herman*

FROM : SAC, NEW ORLEANS (157-386) (P)

SUBJECT: FREEDOM RIDE, 1961  
Trailways Bus No. P224,  
Los Angeles, California, to  
Jackson, Mississippi, 9/9/61  
RM; CR  
OO: New Orleans

Remylet, 12/12/62.

On January 21, 1963, [redacted] b6  
[redacted] First Judicial District Court, Caddo Parish, Shreveport, b7C  
Louisiana, advised his files indicate no further court action  
with reference to charges against [redacted] and [redacted]

*mz*

LEAD

NEW ORLEANS DIVISION

AT SHREVEPORT, LOUISIANA:

Will follow and report state charges against [redacted]  
and [redacted]

32  
EXP. PROC.

2-Bureau  
2-New Orleans

DC/lam  
(4)

EX-118

REC-16

157-387-1452

17 JAN 28 1963

56 JAN 31 1963

*108 172*

*m*  
*SIX*

F B I

Date: 1/25/63

Mr. Tolson	_____
Mr. Belmont	_____
Mr. Mohr	_____
Mr. Casper	_____
Mr. Callahan	_____
Mr. Conrad	_____
Mr. DeLoach	_____
Mr. Evans	_____
Mr. Gale	_____
Mr. Rosen	<i>RRP</i>
Mr. Sullivan	_____
Mr. Tavel	_____
Mr. Trotter	_____
Tele. Room	_____
Miss Holmes	_____
Miss Gandy	_____

Transmit the following in PLAIN TEXT  
(Type in plain text or code)

Via AIRTEL  
(Priority or Method of Mailing)

TO: DIRECTOR, FBI  
FROM: *kn* SAC, MEMPHIS (157-162) (C)

SUBJECT: RACIAL SITUATION IN MISSISSIPPI  
~~SIT DOWN, ILLINOIS CENTRAL RAILROAD STATION~~  
~~CLARKSDALE, MISSISSIPPI~~  
RM

*0 FREEDOM RIDERS - MISC*

Re Memphis airtel to Bureau 8/1/62.

Attached are 8 copies of letterhead memorandum concerning captioned matter.

The information set forth in the letterhead memorandum was furnished to SA

b6  
b7C

Since the information set forth in letterhead memorandum indicates no further prosecutive action is anticipated by local authorities against  and  there appears to be no purpose in further following this matter and, therefore, it is being considered closed by the Memphis Office.

ENCLOSURE

EX-102

Agency G-2, ONI, OSI, CRD

REC-21

3 - Bureau (Encs. 8)  
1 - Memphis  
TSH:gmh

Date Forw... *1-30-63* **157-387-1453**

How Forw... *ad*

By... *adl/dll* 10 JAN 31 1963

*cc det unit  
all's destroyed*

*6-TM*

Airtel... (4)

Teletype... **50 JAN 6 1963**

A. M. ....

A. M. S. D. .... *17 268*

Spec. Del. ....

Reg. Mail. ....

ved: \_\_\_\_\_ Sent \_\_\_\_\_ M Per \_\_\_\_\_  
Special Agent in Charge



UNITED STATES DEPARTMENT OF JUSTICE

FEDERAL BUREAU OF INVESTIGATION

In Reply, Please Refer to  
File No.

Memphis, Tennessee  
January 25, 1963

Re: RACIAL SITUATION IN MISSISSIPPI  
SIT DOWN, ILLINOIS CENTRAL RAILROAD STATION  
CLARKSDALE, MISSISSIPPI  
RACIAL MATTERS

On January 24, <sup>All</sup> 1963, District Attorney [redacted] Mississippi, advised that no action will be taken in the current term of the Circuit Court, Clarksdale, Mississippi, with reference to the appeals of [redacted] and [redacted] who were convicted in City Court and County Court at Clarksdale on breach of peace charges in connection with their sit-down demonstration in the white waiting room of the Illinois Central Railroad Station at Clarksdale on August 23, 1961. Stone further said no further prosecution is anticipated regarding this matter and that it is planned that the case will be continued from term to term of Circuit Court until finally it will be retired from the docket.

b6  
b7c

This document contains neither recommendations nor conclusions of the FBI. It is the property of the FBI and is loaned to your agency; it and its contents are not to be distributed outside your agency.

ENCLOSURE

157-387-1453

FBI

Date: 2/6/63

Transmit the following in \_\_\_\_\_  
(Type in plain text or code)

Via AIRTEL AIR MAIL  
(Priority or Method of Mailing)

TO: DIRECTOR, FBI (157-387)  
FROM: SAC, JACKSONVILLE (157-250) (P)  
SUBJECT: "FREEBUS"  
RM

CORE  
RM

Remyairtel, 12/20/62.

Enclosed herewith are appropriate copies of  
letterhead memorandum reflecting present court action  
against Freedom Riders [redacted]

b6  
b7C

[redacted] and [redacted]  
The Bureau will be advised of all pertinent  
developments.

Agency G-2, ONI, CSI, CRD

Date Forw..... 2/11/63

How Forw..... R-5 REC-64

*4*  
ENCLOSURE

3 - Bureau (Enc. 8) (RM)  
4 - Jacksonville  
(1- 105-66)  
(1- 105-82)  
RWC-ega  
(7)  
50 FEB 13 1963

EX-100 - RBL:caj/57-387-1454  
1 copy Unit  
FEB 8 1963  
2 cc's destroyed

C G- Wick

Approved: [Signature]

Special Agent in Charge

Sent \_\_\_\_\_ M Per \_\_\_\_\_

*[Handwritten initials]*



UNITED STATES DEPARTMENT OF JUSTICE

FEDERAL BUREAU OF INVESTIGATION

Jacksonville, Florida  
February 6, 1963

In Reply, Please Refer to  
File No.

"FREEDOM RIDERS"  
(SECTION TWO, PROFESSIONAL GROUP)

[redacted] First District  
Court of Appeal, Supreme Court Building, Tallahassee,  
Florida, advised January 31, 1963 that Attorney [redacted]  
[redacted] for Freedom Riders [redacted]

b6  
b7c

[redacted] and [redacted] had filed  
petition for "Writ of Certiorari." [redacted] advised  
arguments on the petition will be heard in that court  
on February 5, 1963.

This document contains neither recommendations  
nor conclusions of the Federal Bureau of Investigation.  
It is the property of the Federal Bureau of Investigation  
and is loaned to your agency; it and its contents are not  
to be distributed outside your agency.

157-387-1454  
ENCLOSURE

UNITED STATES GOVERNMENT

# Memorandum

TO : DIRECTOR, FBI (157-387) DATE: 3/12/63

FROM : SAC, NEW ORLEANS (157-386)(P)

SUBJECT: FREEDOM RIDE, 1961  
Trailways Bus No. P224,  
Los Angeles, California to  
Jackson, Mississippi, 9/9/61  
RM; CR  
(OO: NEW ORLEANS)

*exp. pass*

Remylet, 1/25/63.

[redacted] On March 8, 1963, [redacted]  
First Judicial District Court, Caddo Parish,  
Shreveport, Louisiana, advised his files indicate no  
further court action with reference to charges against  
[redacted] and [redacted]

2-Bureau  
2-New Orleans

DC/sms  
(4)

b6  
b7c  
MAR 18 1963

EXP. PROC. [handwritten initials]

EX-115

REC-66

157-387-1155

14  
3 MAR 18 1963

[redacted box]

STX [handwritten initials]

62 MAR 19 1963

UNITED STATES GOVERNMENT

# Memorandum

ALL INFORMATION CONTAINED  
HEREIN IS UNCLASSIFIED  
DATE 11-30-2009 BY 60324 UC BAW/SAB/MJS

TO : DIRECTOR, FBI (157-387)

DATE: 3/20/63

FROM : SAC, JACKSONVILLE (157-250) (C)

SUBJECT: "FREEBUS"  
RM

*1-REASON FOR MISDEMEANORS*

CORE  
RM

Re Jacksonville airtel, 12/20/62.

Enclosed herewith are appropriate copies of letterhead memorandum showing results of District Court of Appeals, First District, State of Florida against Freedom Riders [redacted]

[redacted] and LESLIE LEE SMITH.

b6  
b7c

Agency G-2, ONI, OSI, CRD

Date Forw. MAR 26 1963

How Forw. *By* REC-64

BY *Field* EX-101

157-387-1456

*4*  
ENCLOSURE

- 3 - Bureau (Enc. 8) (RM)
- 3 - Jacksonville (1 - 157-250)
- (1 - 105-66)
- (1 - 105-82)

RWC-ssp  
(6)

62 MAR 29 1963





UNITED STATES DEPARTMENT OF JUSTICE  
FEDERAL BUREAU OF INVESTIGATION

*In Reply, Please Refer to  
File No.*

Jacksonville, Florida  
March 20, 1963

**"FREEDOM RIDERS"  
(SECTION TWO, PROFESSIONAL GROUP)**

[REDACTED] First Circuit  
Court of Appeals, Supreme Court Building, Tallahassee,  
Florida, advised on March 18, 1963, that the First Circuit  
Court of Appeals on February 5, 1963, heard the oral argument  
on instant case. The court entered its opinion on February 26,  
1963, and denied the petition for Writ of Certiorari.

b6  
b7c

This document contains neither recommendations  
nor conclusions of the FBI. It is the property of the FBI  
and is loaned to your agency; it and its contents are not  
to be distributed outside your agency.

UNITED STATES GOVERNMENT

Memorandum

TO : DIRECTOR, FBI (157-387)

DATE: 4/11/63

FROM : SAC, NEW ORLEANS (157-386) (P)

SUBJECT: FREEDOM RIDE, 1961  
Trailways Bus No. P224,  
Los Angeles, California to  
Jackson, Mississippi,  
9/9/61  
RM; CR  
(OO: NEW ORLEANS)

Remylet 3/12/63.

On April 10, 1963, [redacted]  
[redacted] First Judicial District Court, Caddo Parish,  
Shreveport, Louisiana, advised his files indicate no further  
court action with reference to charges against [redacted]  
[redacted] and [redacted]

b6  
b7C

LEAD

NEW ORLEANS DIVISION

AT SHREVEPORT, LOUISIANA

[redacted] Will follow and report state charges against  
[redacted] and [redacted]

2-Bureau  
2-New Orleans  
DC/dmf  
(4)

REC-53

EX-116

157-387-1957

U.S. DEPT. OF JUSTICE

APR 12 10 02 AM '63

APR 15 1963

RECEIVED

3 APR 19 1963

7038

UNITED STATES GOVERNMENT

# Memorandum

ALL INFORMATION CONTAINED  
HEREIN IS UNCLASSIFIED  
DATE 12-1-2009 BY 60324 UC BAW/SAB/MJS

TO : DIRECTOR, FBI (157-387)

DATE: 5/22/63

FROM : SAC, NEW ORLEANS (157-386) (P)

SUBJECT: FREEDOM RIDE, 1961  
Trailways Bus No. P224,  
Los Angeles, California to  
Jackson, Mississippi  
9/9/61  
RM; CR  
OO: NO

Remylet 4/11/63.

On 5/17/63, Mr. SHELBY LAFITTE, Deputy Clerk of  
[redacted] First Judicial District Court, Caddo Parish, Shreveport,  
La., advised his files indicate no further court action with  
reference to charges against [redacted] and [redacted]  
[redacted]

b6  
b7C

NEW ORLEANS - AT SHREVEPORT, LOUISIANA

Will follow and report disposition of state charges  
against [redacted] and [redacted]

- ② - BUREAU
- 2 - NEW ORLEANS
- DC:eah
- (4)

REC-30

EX-112 157-387-1458

MAY 29 1963

63 MAY 29 1963 *ft3*

F B I

Date: 6/27/63

PLAIN TEXT

Transmit the following in \_\_\_\_\_  
(Type in 'plain' text or code)

Via AIRTEL REGISTERED MAIL  
\_\_\_\_\_  
(Priority or Method of Mailing)

TO : DIRECTOR, FBI  
FROM : SAC, NEW YORK (157-892)  
SUBJECT: FREEDOM BUS RIDE TO BALTIMORE, 7/4/63  
RACIAL MATTERS.

FREEDOM RIDERS - MISCELLANEOUS

Enclosed herewith are 8 copies of a letterhead memorandum reflecting that a freedom bus ride from NYC to Baltimore is to take place on 7/4/63.

The source utilized is [redacted] who was unable to furnish any additional information concerning the ride.

b2  
b6  
b7C  
b7D

The NYO is remaining alert for any additional pertinent information.

Bureau of Special Services, NYCPD, advised.

This letterhead memorandum has been classified "Confidential" inasmuch as it contains data which could reasonably result in the identification of a highly confidential source, of continuing value, and compromise his future effectiveness, which would have an adverse effect upon the national defense interests of the country.

- 3 - BUREAU (Encls. 8) (RM)
- 2 - BALTIMORE (Encls. 2) (RM)
- 1 - NY 157-892 (412)

RG0:rvs

REC-35

157-387-11

25 JUN 2

ENCLOSURE

Approved: \_\_\_\_\_ Sent \_\_\_\_\_ M Per \_\_\_\_\_

Special Agent in Charge

CC - Wick



UNITED STATES DEPARTMENT OF JUSTICE

FEDERAL BUREAU OF INVESTIGATION

In Reply, Please Refer to  
File No.

New York, New York  
June 27, 1963

~~CONFIDENTIAL~~

Re: Freedom Bus Ride to Baltimore,  
July 4, 1963  
Racial Matters

A confidential source, who has furnished reliable information in the past, advised on June 26, 1963, that there will be a freedom bus ride originating in New York City to Baltimore, Maryland on July 4, 1963.

This document contains neither recommendations nor conclusions of the FBI. It is the property of the FBI and is loaned to your agency; it and its contents are not to be distributed outside your agency.

~~CONFIDENTIAL~~

GROUP 1  
Excluded from automatic  
downgrading and  
declassification

*Handwritten notes and initials in the top left corner, including "CRD" and "R".*

COMMUNICATIONS SECTION  
JUL 4 1963  
TELETYPE

Mr. Tolson	_____
Mr. Belmont	_____
Mr. Mohr	_____
Mr. Casper	_____
Mr. Callahan	_____
Mr. Conrad	_____
Mr. DeLoach	_____
Mr. Evans	_____
Mr. Gale	_____
Mr. Rosen	_____
Mr. Sullivan	_____
Mr. Tavel	_____
Mr. Trotter	_____
Room	_____
Holmes	_____
Gandy	_____

URGENT 7-4-63 8-16 PM JH

TO DIRECTOR, FBI  
FROM SAC, BALTIMORE 157-725 2P

*riders - Miss [redacted] [redacted]*

FREEDOM BUS RIDE TO BALTIMORE, JULY FOUR, RM

BALTIMORE COUNTY OFFICIALS ADVISED THIS DATE THAT AN ESTIMATED THREE HUNDRED FIFTY INDIVIDUALS CONDUCTED DEMONSTRATION AT GYWN OAK PARK, BALTIMORE COUNTY BEGINNING APPROXIMATELY THREE PM AND ENDING ABOUT 6-45 PM. DEMONSTRATORS INCLUDED FOUR BUSLOADS FROM NEW YORK CITY SEMICOLON ONE BUSLOAD FROM PHILADELPHIA SEMICOLON A NUMBER OF INDIVIDUALS FROM WASHINGTON D.C. AND CORE MEMBERS FROM BALTIMORE.

DEMONSTRATIONS LED BY A GROUP OF RELIGIOUS LEADERS. AMONG THE MINISTERS ARRESTED WERE [redacted] UNITED PRESBYTERIAN CHURCH COMM [redacted] EPISCOPAL BISHOP NYC.

PICKETING WAS CONDUCTED ON GWYNN OAK AVE AT ENTRANCE TO PARK. PRINCIPAL ACTIVITY CENTERED AT ENTRANCE TO PARK. DEMONSTRATORS WERE ARRESTED BASED ON MARYLAND TRESPASS LAW ALTHOUGH SOME WERE CHARGED WITH DISORDERLY CONDUCT. ATTEMPTS WERE MADE TO GAIN ENTRANCE AT BACK ENTRANCE TO PARK AND ARRESTS MADE THERE. ALSO, A GROUP DID GAIN ENTRANCE THRU A SIDE OF THE PARK AND WERE ARRESTED.

END PAGE ONE 1903  
62 JUL 11 1963

*Memo to AB,  
7-5-63  
WAS: CAE*

*6-83*

b6  
b7c

BA 157-725

PAGE TWO

AT PARK ENTRANCE SIT-DOWN TACTICS WERE USED WHICH REQUIRED POLICE TO CARRY THESE PERSONS TO PD TRANSPORTATION. APPROXIMATELY TWO HUNDRED SEVENTYFIVE ARRESTED.

THOSE ARRESTED WERE TAKEN TO WOODLAWN STATION, BA COUNTY PD, UNTIL THAT STATION WAS FILLED TO CAPACITY AND THEN TO WILKENS STATION. BAIL WAS SET AT ONE HUNDRED THREE DOLLARS FOR TRESSPASSING SEMI FIFTY THREE DOLLARS FOR DISORDERLY. ANTICIPATED THAT ALL WOULD MAKE BAIL.

NO INCIDENTS REPORTED. ARRESTS CARRIED OUT IN ORDERLY FASHION. FURTHER DETAILS OF ARRESTS BEING OBTAINED. LETTERHEAD MEMO WILL FOLLOW.

RE PLANNED DEMONSTRATIONS THIS DATE AT WESTMINSTER, MD. MSP ADVISED NO DEMONSTRATIONS CONDUCTED.

END AND ACK

8-24 PM OK F B I WA BH

TU DI



*John...  
CAP...  
JES*

FEDERAL BUREAU OF INVESTIGATION  
U. S. DEPARTMENT OF JUSTICE  
COMMUNICATIONS SECTION

JUL 3 1963

TELETYPE

Mr. Tolson	<input checked="" type="checkbox"/>
Mr. Belmont	<input checked="" type="checkbox"/>
Mr. Mohr	<input type="checkbox"/>
Mr. Casper	<input type="checkbox"/>
Mr. Callahan	<input type="checkbox"/>
Mr. Conrad	<input type="checkbox"/>
Mr. DeLoach	<input checked="" type="checkbox"/>
Mr. Evans	<input type="checkbox"/>
Mr. Gale	<input type="checkbox"/>
Mr. Rosen	<input checked="" type="checkbox"/>
Mr. Sullivan	<input type="checkbox"/>
Mr. Tavel	<input type="checkbox"/>
Trotter	<input type="checkbox"/>
Room	<input type="checkbox"/>
Holmes	<input type="checkbox"/>
Gandy	<input type="checkbox"/>

URGENT 7-3-63 4-15 PM KAC

TO DIRECTOR AND SAC, NEW YORK  
NEW YORK VIA WASHINGTON

FROM SAC, BALTIMORE /157-725/ 1 P

FREEDOM BUS RIDE TO BALTIMORE, JULY FOUR, SIXTY THREE,  
Riders - Miscellaneous  
RACIAL MATTERS.

RE NEW YORK AIRTEL TO BUREAU JULY FIRST, SIXTY THREE

ON THIS DATE [REDACTED] ADVISED THAT TEN

BUS LOADS OF WHITES AND NEGROES, HEADED BY [REDACTED]  
PRESBYTERIAN COUNCIL OF CHURCHES, NEW YORK, ARE TO DEMONSTRATE  
IN THE MARYLAND AREA AT WESTMINSTER, CARROLL COUNTY, MARYLAND  
AND GYNN OAK PARK, BALTIMORE COUNTY, MARYLAND WITH BA CORE GROUP,  
ON JULY FOUR, NEXT. PLANS ARE TO MEET AT THE METROPOLITAN CHURCH  
BALTIMORE AT TEN A. M. AND DISPERSE FROM THERE TO ASSIGNED AREAS.  
APPROPRIATE LOCAL AUTHORITIES ADVISED. BA WILL FOLLOW.

END AND ACK PLS.

4-18 PM OK FBI WA WS R RELQAY

TU DISC

M

REC-11 157-387-1461

EX-112  
MR. BELMONT FOR THE DIRECTOR

JUL 8 1963

CC-MR. ROSEN

57 JUL 15 1963  
RELAYED TO [REDACTED]  
836

b2  
b6  
b7C  
b7D

FEDERAL BUREAU OF INVESTIGATION  
U. S. DEPARTMENT OF JUSTICE  
COMMUNICATIONS SECTION  
JUL 4 1963

ALL INFORMATION CONTAINED  
HEREIN IS UNCLASSIFIED  
DATE 12-01-2009 BY 60324 UC-BAW/SAB/WIS-

Mr. Tolson	_____
Mr. Belmont	_____
Mr. Mohr	_____
Mr. Casper	_____
Mr. Callahan	_____
Mr. Conrad	_____
Mr. DeLoach	_____
Mr. Evans	_____
Mr. Gale	_____
Mr. Rosen	_____
Mr. Sullivan	_____
Mr. Tavel	_____
Mr. Trotter	_____
Tele. Room	_____
Miss Holmes	_____
Miss Gandy	_____

TELETYPE

NA  
3 3/2 PM 7/4/63  
J. Martin  
prep rec  
1:00 PM  
7-4-63

URGENT 7-4-63 2-18 PM LMQ

TO DIRECTOR, FBI

FROM SAC, BALTIMORE 157-725

*Miscellaneous*

FREEDOM BUS RIDE TO BALTIMORE, JULY FOUR. RM.

REBATEL JULY THREE, SIXTYTHREE.

[Redacted]

ADVISED FOUR BUSLOADS FROM NEW YORK

CITY SEMICOLON ONE BUSLOAD FROM PHILADELPHIA SEMICOLON A NUMBER OF PER-  
SONS FROM WASHINGTON D.C. TOGETHER WITH BA CORE MEMBERS HAVE BEEN  
MEETING AT METROPOLITAN CHURCH, BALTIMORE TODAY. PLANS ARE FOR  
TOKEN DEMONSTRATIONS AT WESTMINSTER, MD. AND CONCENTRATED ACTIVITY  
AT GWYNN OAK PARK, BA COUNTY, MD., ON OUTSKIRTS OF BALTIMORE.  
DEMONSTRATIONS ARE TO BEGIN ABOUT THREE P.M. AND TO BE LED BY A  
NUMBER OF MINISTERS.

b2  
b6  
b7C  
b7D

LOCAL AUTHORITIES HAVE BEEN CONTINUOUSLY ADVISED.

BALTIMORE WILL FOLLOW.

END AND ACK.

WA 2-21 PM OK FBI WA RL

TU DISC

*Memo to AG; 112*  
*REC-12*  
*157-387-1462*  
*7-5-63*  
*WAS: CAC*  
JUL 8 1963

58 JUL 11 1963

*6-70*

FEDERAL BUREAU OF INVESTIGATION  
U. S. DEPARTMENT OF JUSTICE  
COMMUNICATIONS SECTION  
JUL 3 1963

TELETYPE

- Mr. Tolson \_\_\_\_\_
- Mr. Belmont \_\_\_\_\_
- Mr. Mohr \_\_\_\_\_
- Mr. Casper \_\_\_\_\_
- Mr. Callahan \_\_\_\_\_
- Mr. Conrad \_\_\_\_\_
- Mr. DeLoach \_\_\_\_\_
- Mr. Evans \_\_\_\_\_
- Mr. Gale \_\_\_\_\_
- Mr. Rosen \_\_\_\_\_
- Mr. Sullivan \_\_\_\_\_
- Mr. Tavel \_\_\_\_\_
- Mr. Trotter \_\_\_\_\_
- Tele. Room \_\_\_\_\_
- Miss Holmes \_\_\_\_\_
- Miss Gandy \_\_\_\_\_

NIA  
1:50 AM 7/4/63  
[Redacted]  
7-3-63

URGENT 7-3-63 11-41 PM JJW

TO DIRECTOR -16- AND SAC BALTIMORE 157-725

FROM SAC NEW YORK 157-0 FREEDOM RIDERS - MISC

FREEDOM BUS RIDE TO BALTIMORE, SEVEN FOUR SIXTY THREE., RACIAL MATTERS.

RENYAIRTEL TO BUREAU, JULY ONE, NINETEEN SIXTY THREE.

[Redacted] CORE, NYC, ADVISED THIS DATE CAPTIONED BUS RIDE UNDER SPONSORSHIP OF BROOKLYN, NY CHAPTER OF CORE, AMERICANS FOR DEMOCRATIC ACTION / ADA / AND DISTRICT SIXTY FIVE, RETAIL WHOLESALE AND DEPARTMENT STORE UNION / RWDSU /, NYC. CORE, NYC, HAS SACTIONED THIS BUS RIDE BUT WILL TAKE NO ACTIVE PART. [Redacted] STATED FURTHER DETAILS CAN BE OBTAINED FROM ARTHUR GORSON, ADA, COORDINATOR OF BUS RIDE.

b6  
b7c

ARTHUR GORSON, NATIONAL CHAIRMAN, YOUTH DIVISION, ADA, ADVISED THIS DATE, APPROXIMATELY THREE HUNDRED PERSONS IN FIVE BUSES WILL DEPART NYC AT SEVEN AM, JULY FOUR, NINETEEN SIXTY THREE FOR MARYLAND TO PARTICIPATE IN DEMONSTRATION MOST LIKELY AT GWYNN OAK PARK OUTSIDE BALTIMORE. GORSON STATED THAT THERE MAY BE OTHER POINTS FOR DEMONSTRATION TO TAKE PLACE BUT COULD FURNISH NO FURTHER INFORMATION RE THIS. GORSON ADVISED BUSES CARRYING DEMONSTRATORS WILL BE FROM RELIABLE BUS COMPANY.

157-387-1463

END

NY R 16 WA HFL 11-46 PM

62 JUL 11 1963

memo to AG,  
7-5-63  
WAB:CAR

REC 31  
EX - 112

6. [Signature]

FEDERAL BUREAU OF INVESTIGATION  
U.S. DEPARTMENT OF JUSTICE  
COMMUNICATIONS SECTION  
JUL 5 1963

TELETYPE

Mr. Tolson	_____
Mr. Belmont	_____
Mr. Mohr	_____
Mr. Casper	_____
Mr. Callahan	_____
Mr. Conrad	_____
Mr. DeLoach	_____
Mr. Evans	_____
Mr. Gale	_____
Mr. Rosen	_____
Mr. Sullivan	_____
Mr. Tavel	_____
Mr. Trotter	_____
Tele. Room	_____
Miss Holmes	_____
Miss Gandy	_____

*CRD*  
*Indorse 7/5/63*  
*yes*

URGENT 7-5-63 12-21 AM JH

TO DIRECTOR, FBI

FROM SAC, BALTIMORE /157-725/ FREEDOM RIDERS-

FREEDOM BUS RIDE TO BALTIMORE, JULY FOUR, RM

*LMS*



b6  
b7c

RE BA TEL JULY FOUR.

CHIEF INSPECTOR  BA COUNTY P.D. ADVISED LATE THIS EVENING TOTAL ARRESTS AT GYWN OAK PARK ARE APPROXIMATELY TWO HUNDRED EIGHTYFIVE. DEFINITE FIGURE NOT AVAILABLE AT THIS TIME. PROCESSING OF THOSE ARRESTED NOT EXPECTED TO BE COMPLETED FOR SEVERAL HOURS. APPROXIMATELY HALF OF THOSE ARRESTED HAVE POSTED BOND. THE REMAINING INDIVIDUALS ARE REFUSING TO POST BOND FOR THEIR RELEASE. TRIAL DATE FOR THOSE RELEASED SET AT 7-30 P.M. SEVEN EIGHT SIXTYTHREE AND FOR THE OTHERS AT 7-30 P.M. SEVEN FIVE SIXTYTHREE.

*9*

COMPLETE DETAILS OF ARRESTS WILL BE OBTAINED AND FURNISHED TO BUREAU.

LETTERHEAD MEMO WILL FOLLOW.

END AND ACK

12-25 AM OK FBI WA HFL

DISCO

*Memo to AS 157-387-1464*  
*7-5-63*  
*REC 31*  
*WAS: CA EX-101*  
*5 JUL 8 1963*  
*6.27*

*75*  
51 JUL 11 1963

FEDERAL BUREAU OF INVESTIGATION  
U. S. DEPARTMENT OF JUSTICE  
COMMUNICATIONS SECTION  
JUL 4 1963

TELETYPE

Mr. Tolson	_____
Mr. Belmont	_____
Mr. Mohr	_____
Mr. Casper	_____
Mr. Callahan	_____
Mr. Conrad	_____
Mr. DeLoach	_____
Mr. Evans	_____
Mr. Gale	_____
Mr. Rosen	_____
Mr. Sullivan	_____
Mr. Tavel	_____
Mr. Trotter	_____
Tele. Room	_____
Miss Holmes	_____
Miss Gandy	_____

b6  
b7c

NA  
3:30 PM  
7/4/63

[Redacted box]

Handwritten initials and scribbles.

URGENT 7-4-63 1-25 PM DLO

TO DIRECTOR, FBI -3- AND SAC, BALTIMORE /157-72

FROM SAC, NEW YORK /157-1 1P

SUBJECT FREEDOM RIDERS BUS RIDE TO BALTIMORE,  
7/4/63

[Redacted box]

RACIAL MATTERS

RENYTEL TO BUREAU AND BALTIMORE, SEVEN THREE SIXTY THREE, AND NEW YORK PHONE CALL TO BALTIMORE, EIGHT FORTY AM, SEVEN ~~SIX~~ SIXTY THREE.

FOUR CHARTERED BUSES WITH FIFTY TWO PASSENGERS ON EACH DEPARTED NYC EIGHT TWENTY AM INSTANT EN ROUTE BALTIMORE. THREE BUSES, LIGHT GREEN AND ALUMINUM, ONE RED AND ALUMINUM. BUSES BEAR FOLLOWING IDENT NUMBERS AND NEW JERSEY LICENSE NUMBERS--NUMBER TWO ZERO ONE, OWH SEVEN ONE TWO. NUMBER TWO ZERO ZERO, OWD EIGHT ONE THREE; NUMBER TWO ZERO THREE, OWB SIX SIX EIGHT., NUMBER FIVE ONE ONE, OWR NINE NINE EIGHT.

BUSES PROPERTY OF RELIABLE COACH COMPANY, NEWARK, NEW JERSEY.

END AND PLS ACK

1-30 PM NY R -3- WA RL

JUL 12 1963

Handwritten notes: Memo to AS, 7-5-63, WAS, CAE

6 JUL 8 1963

Handwritten initials/signature.

FEDERAL BUREAU OF INVESTIGATION  
U. S. DEPARTMENT OF JUSTICE  
COMMUNICATIONS SECTION  
JUL 6 1963

TELETYPE

Mr. Tolson	_____
Mr. Belmont	_____
Mr. Mohr	_____
Mr. Casper	_____
Mr. Callahan	_____
Mr. Conrad	_____
Mr. DeLoach	_____
Mr. Evans	_____
Mr. Gale	_____
Mr. Rosen	_____
Mr. Sullivan	_____
Mr. Tavel	_____
Mr. Trotter	_____
Tele. Room	_____
Miss Holmes	_____
Miss Gandy	_____

*Copy Original  
telephonically advised  
11:00 P.M. 7/6/63  
WJG*

URGENT 7/6/63 5-14 PM BPN

TO DIRECTOR, FBI

FROM SAC, BALTIMORE /157-725/ 1P

FREEDOM BUS RIDE TO BALTIMORE JULY FOUR SIXTY THREE  
RACIAL MATTERS. *Freedom Riders - Misc*

RE BALTIMORE TEL JULY SIX SIXTY THREE.

ON JULY SIX SIXTY THREE, INSPECTOR [REDACTED] BALTIMORE

COUNTY POLICE DEPARTMENT, ADVISED THAT THE DEMONSTRATORS  
RELEASED FROM JAIL LAST NIGHT ARE PLANNING ANOTHER DEMONSTRATION  
SUNDAY, JULY SEVEN NEXT AT GWYNN OAK PARK. PLANS ARE TO MEET AT  
THE METROPOLITAN METHODIST CHURCH, BALTIMORE, AT THREE PM.

[REDACTED] ONE OF THE LEADERS HAS ASKED BALTIMORE  
PASTORS TO APPEAL FOR SUPPORT FOR TOMORROWS DEMONSTRATION.

APPROPRIATE LOCAL AUTHORITIES ADVISED.

REC-11 157-387-1466

3 JUL 8 1963

BALTIMORE WILL FOLLOW.

END AND ACK PLS.

5-17 PM OK FBI WA WS

TU DISC

EX-112

*687*

51 JUL 15 1963

*AG Memo  
RS State of Md  
7/8/63 PAF:MS  
036*

b6  
b7c

Mr. Tolson	_____
Mr. Belmont	_____
Mr. Mohr	_____
Mr. Casper	_____
Mr. Callahan	_____
Mr. Conrad	_____
Mr. DeLoach	_____
Mr. Evans	_____
Mr. Gale	_____
Mr. Rosen	_____
Mr. Sullivan	_____
Mr. Tavel	_____
Mr. Trotter	_____
Tele. Room	_____
Miss Holmes	_____
Miss Gandy	_____

RECEIVED  
JUL 7 1963  
TELETYPE

CR Dir. advised  
5:58 PM 7/7/63  
MS

URGENT 7/7/63 6-47 PM  
TO DIRECTOR, FBI  
FROM SAC, BALTIMORE /157-725/ 1-P

FREEDOM BUS RIDE TO BALTIMORE, JULY FOUR COMMA SEVEN,  
RACIAL MATTERS. OF FREEDOM RIDERS - MISC.

BALTIMORE COUNTY PD ADVISED THAT APPROXIMATELY THREE FORTY FIVE PM, TEN TO TWELVE INDIVIDUALS CARRYING SIGNS OF THE FIGHTING AMERICAN NATIONALISTS BEGAN PICKETING OUTSIDE THE ENTRANCE TO GWYNN OAK PARK. SIGNS WERE BASICALLY ANTI-INTEGRATION.

DEMONSTRATORS FOR INTEGRATION BEGAN ARRIVING AT THE PARK AT ABOUT FIVE THIRTY PM. AN ESTIMATED SIXTY INDIVIDUALS WERE IN THIS GROUP. AT ABOUT FIVE FORTY FIVE PM MOST OF THESE WERE ARRESTED BY BA COUNTY PD. NO INCIDENTS AND NO VIOLENCE REPORTED.

BA WILL FOLLOW.

END AND ACK

SSSSSS

6-51 PM OK FBI WA MGR

TU DISC

REC-6 157-387-1467  
3 JUL 8 1963

AG memo  
RS State of Md  
7/8/63 Aff: NS

51 JUL 15 1963

b6  
b7c

Mr. Tolson	_____
Mr. Belmont	_____
Mr. Mohr	_____
Mr. Casper	_____
Mr. Callahan	_____
Mr. Conrad	_____
Mr. DeLoach	_____
Mr. Evans	_____
Mr. Gale	_____
Mr. Rosen	_____
Mr. Sullivan	_____
Mr. Tavel	_____
Trotter	_____
Room	_____
Holmes	_____
Gandy	_____

FEDERAL BUREAU OF INVESTIGATION  
U. S. DEPARTMENT OF JUSTICE  
COMMUNICATIONS SECTION  
JUL 5 1963  
**TELETYPE**

*CRD*  
*7/6/63*  
*2nd*

DEFERRED 7/5/63 2/05 PM JEN

TO DIRECTOR, FBI

FROM SAC, BALTIMORE /157-725/

*FREEDOM RIDERS - MISC*  
FREEDOM BUS RIDE TO BALTIMORE, JULY FOUR, RACIAL MATTER

RE BA TEL JULY FIVE, .

INSPECTOR [REDACTED] BA COUNTY PD, ADVISED THIS DATE

ARREST TOTAL AT GWYNN OAK PARK ON JULY FOUR, WAS TWO HUNDRED

EIGHTY-SIX. ONE HUNDRED AND TWELVE RELEASED ON BAIL AND

SCHEDULED FOR TRIAL JULY EIGHT. REMAINING ONE HUNDRED SEVENTY-

FOUR CONFINED AT VARIOUS BALTIMORE COUNTY JAILS AND SCHEDULED

FOR TRIAL JULY FIVE. NO KNOWN ACTIVITY PLANNED FOR JULY FIVE OR

SIX. BA WILL FOLLOW.

END AND ACK

*EX-116*  
*REC-1157-387-1468*  
*3 JUL 8 1963*  
*7/6/63*  
*6-67*

62 3:07 PM OK FBI WA JDS  
TU

b6  
b7c



*Next AM*  
7-8-63 9:40 PM  
7-8-63 ~~SD~~  
b6  
b7C

ALL INFORMATION CONTAINED  
HEREIN IS UNCLASSIFIED  
DATE 12-01-2009 BY 60324 UC BAW/SAB/MJS

TELETYPE

- Mr. Tolson \_\_\_\_\_
- Mr. DeLoach \_\_\_\_\_
- Mr. Casper \_\_\_\_\_
- Mr. Callahan \_\_\_\_\_
- Mr. Conrad \_\_\_\_\_
- Mr. DeLoach \_\_\_\_\_
- Mr. Evans \_\_\_\_\_
- Mr. Gale \_\_\_\_\_
- Mr. Rosen \_\_\_\_\_
- Mr. Sullivan \_\_\_\_\_
- Mr. Tavel \_\_\_\_\_
- Mr. Trotter \_\_\_\_\_
- Tele. Room \_\_\_\_\_
- Miss Holmes \_\_\_\_\_
- Miss Gandy \_\_\_\_\_

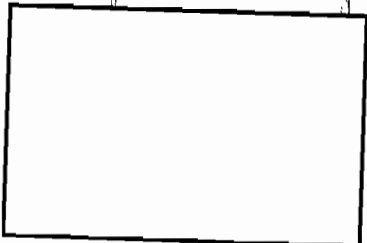

URGENT 7-8-63 6-32 PM WEW

TO DIRECTOR, FBI

FROM SAC, BALTIMORE /157-725/ 1P

RIDERS  
FREEDOM BUS RIDE TO BALTIMORE, JULY FOUR TO JULY SEVEN

LAST, RACIAL MATTERS.

RE BALTIMORE TEL JULY SEVEN LAST.

LT. WOODLAWN STATION, BALTIMORE CO.

b6  
b7C

PD, ADVISED THIS DATE THAT ONE HUNDRED ADULTS WERE ARRESTED DURING THE GWYNN OAK DEMONSTRATION OF JULY SEVEN LAST. ALL WERE CHARGED WITH TRESPASSING, SOME ALSO CHARGED WITH DISORDERLY CONDUCT OR CONSPIRACY OR BOTH.

SEVENTY SEVEN RELEASED ON BOND, SIXTEEN MEN CONFINED WOODLAWN STATION, SEVEN WOMEN CONFINED BA CO JAIL, TOWSON. TRIAL DATE JULY TEN NEXT. LTRHD M FOLLOWING.

END AND ACK PLS

6-35 PM OK FBI WA NH  
TU DISC

REC-26 157-387-1469

EX-101 10 JUL 9 1963

6-60

AG Memo  
RS  
7/9/63  
157-725-1469  
1963  
G36

*Handwritten:* 10:00 AM received 7-8-63  
T. J. SP...  
ED

FEDERAL BUREAU OF INVESTIGATION  
U.S. DEPARTMENT OF JUSTICE  
COMMUNICATIONS SECTION  
JUL 8 1963  
TELETYPE

Mr. Tolson	.....
Mr. Belmont	.....
Mr. Mohr	.....
Mr. DeLoach	.....
Mr. Casper	.....
Mr. Callahan	.....
Mr. Conrad	.....
Mr. Felt	.....
Mr. Gale	.....
Mr. Rosen	.....
Mr. Sullivan	.....
Mr. Tavel	.....
Mr. Trotter	.....
Tele. Room	.....
Miss Holmes	.....
Miss Gandy	.....

*Handwritten:* BH

b6  
b7C

URGENT 7-8-63 6-15 PM WEW

TO DIRECTOR, FBI

FROM SAC, BALTIMORE /157-725/ 1P

FREEDOM <sup>RIDERS</sup> BUS RIDE TO BALTIMORE, JULY FOUR, SEVEN,  
SIXTYTHREE, RACIAL MATTERS.

REFERENCE BALTIMORE TEL. JULY SEVEN, LAST.

LT. [REDACTED] WOODLAWN STATION, BALTIMORE COUNTY  
PD, ADVISED THIS DATE THAT FIFTYFOUR GWYNN OAK DEMONSTRATORS  
ARRESTED JULY FOUR APPEARED IN WOODLAWN MAGISTRATE-S COURT IN THE  
P.M. OF JULY EIGHT, INSTANT. THEY PLEADED NOT GUILTY AND ASKED  
FOR JURY TRIAL ON ALL CHARGES.

THIRTYSEVEN SCHEDULED TO APPEAR DID NOT APPEAR NO ACTION TAKEN  
BY COURT TO DATE RE THESE INDIVIDUALS. NO TRIAL DATE SET FOR ANY  
OF ABOVE. BALTIMORE WILL FOLLOW.

END AND ACK PLS

6-20 PM OK FBI WA BH

TU DIS 38

*Handwritten:* 55 JUL 12 1963  
AG...  
RS...  
7/9/63

REC-78

*Handwritten:* 157-387-1470

JUL 9 1963

*Handwritten:* 6-12

ALL INFORMATION CONTAINED  
HEREIN IS UNCLASSIFIED  
DATE 12-01-2009 BY 60324 UC BAW/SAB/MJS  
JUL 8 1963

TELETYPE

Mr. Tolson	_____
Mr. Belmont	_____
Mr. Mohr	_____
Mr. Casper	_____
Mr. Callahan	_____
Mr. Conrad	_____
Mr. DeLoach	_____
Mr. Evans	_____
Mr. Gale	_____
Mr. Rosen	<input checked="" type="checkbox"/>
Mr. Sullivan	_____
Mr. Tavel	_____
Mr. Trotter	_____
Tele. Room	_____
Miss Holmes	_____
Miss Gandy	_____

*ack 7/6/63*  
*RLB*

URGENT 7-6-63

4-05AM RLB

b6  
b7c

TO DIRECTOR FBI

FROM SAC BALTIMORE /157-7251 FREEDOM RIDERS - MISC.

FREEDOM BUSRIDE TO BALTIMORE, JULY FOUR SIXTYTHREE. RM.

REF. BA TEL JULY FIVE SIXTYTHREE.

LT. [REDACTED] WOODLAWN STATION, BALTIMORE COUNTY PD,

ADVISED THIS DATE APPROXIMATELY ONE HUNDRED SEVENTY FOUR GWYNN

OAK DEMONSTRATORS APPEARED IN WOODLAWN MAGISTRATES COURT IN THE  
PM OF JULY <sup>FIVE</sup> SEVEN SIXTYTHREE. THEY PLEADED <sup>REC-114</sup> NOT GUILTY AND

ASK FOR JURY TRIAL ON ALL CHARGES. NO TRIAL DATE SET.\* BA WILL

FOLLOW.

END AND ACK PLS

629 JAM OKUFBS WA JR  
TU DISC

*\*all were released on bond  
or personal recognizance.*

*Trans to G2  
(State of Md)  
7/6/63 JRB/ST*

157-7251-1471  
JUL 8 1963

ALL INFORMATION CONTAINED  
HEREIN IS UNCLASSIFIED  
DATE 12-01-2009 BY 60324 UC BAW/SAB/MJS

JUL 2 1963

TELETYPE

- Mr. Tolson \_\_\_\_\_
- Mr. Belmont \_\_\_\_\_
- Mr. Mohr \_\_\_\_\_
- Mr. Casper \_\_\_\_\_
- Mr. Callahan \_\_\_\_\_
- Mr. Conrad \_\_\_\_\_
- Mr. DeLoach \_\_\_\_\_
- Mr. Evans \_\_\_\_\_
- Mr. Gale \_\_\_\_\_
- Mr. Rosen \_\_\_\_\_
- Mr. Sullivan \_\_\_\_\_
- Mr. Tavel \_\_\_\_\_
- Mr. Trotter \_\_\_\_\_
- Tele. Room \_\_\_\_\_
- Miss Holmes \_\_\_\_\_
- Miss Gandy \_\_\_\_\_

URGENT 7/7/63 9-55 PM BPN

TO DIRECTOR, FBI

FROM SAC, BALTIMORE /157-725/ 2-P

FREEDOM BUS RIDE TO BALTIMORE JULY FOUR COMMA SEVEN,  
RACIAL MATTERS.

RE MY TEL THIS DATE.

CAPT. [ ] BA COUNTY PD ADVISED THAT DEMONSTRATIONS CONTINUED AT GWYNN OAK PARK, BA COUNTY UNTIL APPROXIMATELY SEVEN THIRTY PM. AN ESTIMATED THREE HUNDRED FIFTY INDIVIDUALS TOOK PART IN THE DEMONSTRATIONS ATTEMPTING TO GAIN ENTRANCE TO THE PARK AT THE MAIN ENTRANCE AND ALSO AT THE BACK OF THE PARK. INCLUDED IN THE DEMONSTRATORS WERE CLERGYMEN OF VARIOUS FAITHS.

APPROXIMATELY EIGHTY NINE INDIVIDUALS WERE ARRESTED. EXACT NUMBER NOT KNOWN AND PROCESSING WILL CONTINUE THROUGHOUT THE NIGHT. ALL THOSE ARRESTED WERE TAKEN TO PIKESVILLE ARMORY, PIKESVILLE, MD. WHERE ADEQUATE FACILITIES HAD BEEN SET UP. CHARGES ARE FOR TRESSPASSING UNDER THE MARYLAND TRESSPASS LAW SEMICOLON SOME WERE ALSO CHARGED WITH DISORDERLY CONDUCT. ARRANGEMENTS HAVE BEEN MADE FOR THOSE ARRESTED TO POST BAIL.

MEMBERS OF THE FAN GROUPS CONTINUED THEIR PICKETING INSIDE THE PARK UNTIL APPROXIMATELY SEVEN FIFTEEN PM.

CAPT. [ ] ADVISED THERE WAS ONLY ONE REPORTED INCIDENT AT THE PARK. A WOMAN WAS HIT WITH A STONE SEMICOLON DETAILS OF THIS ARE NOT

END PAGE ONE.

62 JUL 15 1963

6-87

b6  
b7c

AG Memo  
R.S. State of Md  
7/8/63  
FPP-MS

W/MS

APD  
7/7/63  
60

[Redacted]

[Redacted]

EX-101 REC-33 157-387-1472

PAGE TWO..

KNOWN TO THE PD AT THIS TIME.

DEMONSTRATION WAS ORDERLY. NO KNOWN ACTS OF VIOLENCE.

LETTERHEAD MEMO WILL FOLLOW.

END AND ACK PLS.

1002 PM OK FBI WA OS

TU DISCO

UNITED STATES GOVERNMENT

# Memorandum

TO : DIRECTOR, FBI

DATE: 7/22/63

FROM : SAC, BUFFALO (157-127) (RUC)

SUBJECT: CHANGED  
[redacted] aka  
[redacted]  
INFORMATION CONCERNING  
(OO Knoxville)

Re Knoxville airtel to Bureau dated 7/3/63 in captioned case, report of SA HUNTER E. HELGESON, dated 7/26/61, and Buffalo letter dated 9/18/61 (with LHM) captioned "FREEDOM RIDERS, 1961 ILLINOIS CENTRAL RAILROAD, NEW ORLEANS, LOUISIANA TO JACKSON, MISSISSIPPI, JUNE 25, 1961, RM; CR." b7C

The title was "Changed" to include subject's middle name.

Rerep reflects [redacted] N.Y., who is of [redacted] race, and who was born [redacted] along with twenty freedom riders arrived in Jackson, Mississippi via railroad, June 25, 1961, and were thereafter arrested by the Jackson Police Department at the railroad depot when they failed to obey orders of the Jackson Police Department to move on. All were charged with breach of the peace. There were no incidents at the time of the arrest.

Nineteen of the group, including [redacted] were tried in Jackson, Mississippi court June 26, 1961, and after not guilty pleas, were convicted of violation of Section 2087.5 of the Mississippi Code. They were sentenced to four months in jail and fined \$200.00. [redacted] was incarcerated in the Mississippi State Prison at Parchman, Mississippi.

According to the report, [redacted] is [redacted] tall, weighed [redacted] pounds, has [redacted] eyes, [redacted] hair, and a [redacted] build. He was a student at the University of Rochester at the time, and his parents were PHILIP and FLORA HARRIS, 147 Summit Drive, [redacted]

- 3 - Bureau
  - 2 - Knoxville (62-731)
  - 1 - Birmingham (Info.)
  - 1 - New York (Info.)
  - 1 - Buffalo
- RHP:jrz

62 JUL 31 1963

JUL 24 1963

EX-108

BU 157-127

He had been arrested previously at Rochester, N.Y., for vagrancy in 1956; and admitted picket line activity in Rochester and Albany, N.Y., New York City; is a member of the Congress of Racial Equality (CORE); and is a member of the National Association for the Advancement of Colored People. He claims to be a conscientious objector.

The June 22, 1961 "Rochester Times Union" (Rochester, N.Y. city wide newspaper), carried an article "Young Man Accepted As Freedom Rider" which reflects GORDON L. HARRIS, 147 Summit Drive, Rochester, N.Y., was the first Rochester resident to be accepted for a mission as a freedom rider and was scheduled to leave that day. His acceptance came from the Congress of Racial Equality.

The article read that HARRIS would first go to New York City for briefing; then to New Orleans, and from there to participate in freedom rides in Jackson, Mississippi.

The article mentioned that HARRIS is a Pacifist by conviction and believes in non violent methods of achieving racial equality. He stated he was prepared for any eventuality in the South, even a long jail sentence.

The August 7, 1961 edition of the "Rochester Times Union" reflects GORDON L. HARRIS, after serving 42 days of his four month sentence, was released from the State Penitentiary in Mississippi.

[redacted] Credit Bureau of Rochester, N.Y., incorporated, on September 14, 1961, did not locate a record identifiable with [redacted]

[redacted] Identification Division, Rochester, N.Y. Police Department, on September 14, 1961, said [redacted]

[redacted] born [redacted] in [redacted] was arrested in Rochester July 21, 1961, for speeding, and on March 14, 1957 for vagrancy. [redacted] said the vagrancy charge stemmed out of an arrest at 1:05 AM, at which time [redacted]

b6  
b7c

BU 157-127

[redacted] at the time, did not give a satisfactory explanation for a deposit notation in a bankbook in his possession and the fact that he was unemployed. The warrant was eventually withdrawn and dismissed.

b6  
b7c

Captain [redacted] Rochester Police Department, on August 25, 1961, said that in connection with the arrest of [redacted] on March 14, 1957, [redacted] in the early hours of that day, was observed marching around in a parking lot on Monroe Avenue in Rochester and carrying a lighted torch. When asked what he was doing, he merely questioned as to what law he was breaking. When Captain [redacted] replied that it was odd that a person would be marching around at that time of the day with a lighted torch, [redacted] gave no reply. [redacted] said that inasmuch as no fires had been started in the area and because there was no explanation for [redacted] actions, he had no alternative other than to withdraw the complaint and recommend to the parents that [redacted] have a mental examination.

[redacted] explained that [redacted] bankbook contained notations of deposits, although unemployed, because of the fact that [redacted] parents did not live in harmony with him and therefore, at their suggestion, paid him a weekly amount to live elsewhere.

A photograph of [redacted] is on file at the Buffalo Office.

Informational copies of this communication were furnished Birmingham and New York in view of leads set forth for those offices in referenced Knoxville airtel.



UNITED STATES GOVERNMENT

# Memorandum

TO : DIRECTOR, FBI (157-387)

DATE: 7/29/63

FROM : *Hom* SAC, NEW ORLEANS (157-386) (P)

SUBJECT: *o*  
FREEDOM RIDE, 1961  
Trailways Bus No. P224,  
Los Angeles, California,  
to Jackson, Mississippi  
9/9/61  
RM; CR  
(OO: NEW ORLEANS)

*mz*  
Remylet 5/22/63.

On 7/23/63 [redacted]  
First Judicial District Court, Caddo Parish, Shreveport,  
Louisiana, advised his files indicate no further court action  
with reference to charges against [redacted] and  
[redacted]

b6  
b7c

LEAD

NEW ORLEANS DIVISION

AT SHREVEPORT, LOUISIANA:

Will follow and report disposition of state charges  
against [redacted] and [redacted]

- 2 - Bureau
- 2 - New Orleans

DC/scw  
(4)

REC-21

*157-387-1471*

AUG 31 1963  
LDR

U.S. DEPARTMENT OF JUSTICE

AUG 31 1963

57 AUG 6 1963

[Large redacted box with handwritten 'SIX' and other marks]

*Ch*  
EX-100

UNITED STATES GOVERNMENT

# Memorandum

DIRECTOR, FBI

DATE: 8/16/63

SAC, NEW YORK (62-13027) RUC

SUBJECT:

[redacted] aka  
INFORMATION CONCERNING  
OO: Knoxville

0 FREEDOM RIDERS

Re. Knoxville airtel to Bureau 7/3/63, and Buffalo  
ltr to Bureau 7/22/63.

On 7/17/63, IC. ANTHONY AMOROSO, reviewed the records of the Bureau of Motor Vehicles, New York City, and there was no records of the subject having an automobile registered in NYC for 1963. Previous registrations are maintained at Albany, NY.

b6  
b7c

On 7/25/63, recprds of the Bureau of Criminal Identification, New York City Police Department were reviewed by SA [redacted] and there was no record identifiable with the subject.

Records of the Bureau of Special Services, New York City Police Department, were reviewed by SA [redacted] on 8/26/63, and there was no record identifiable with the subject.

Indices of the NYO were reviewed and the only information identifiable with the subject is the same as that set forth in refernced Buffalo letter of 7/22/63.

- 2 - Bureau (
- 2 - Knoxville (62-731)
- 1 - New York (62-13027)

DJQ:slf  
(5)

REC-28 157-387-1475

2 AUG 19 1963

EX-103

55 AUG 28 1963

F 141

5  
[Handwritten signature]

UNITED STATES GOVERNMENT

# Memorandum

TO : DIRECTOR, FBI (157-387)

DATE: 9/17/63

FROM: SAC, NEW ORLEANS (157-386) (P)

SUBJECT: FREEDOM RIDE, 1961  
Trailways Bus No. P224  
Los Angeles, California to  
Jackson, Mississippi  
9/9/61  
RM; CR  
(OO: NO)

Remylet 7/29/63.

On 9/10/63, [redacted]

[redacted] First Judicial District Court, Caddo Parish,  
Shreveport, Louisiana, advised his files indicate no  
further court action with reference to state charges  
against [redacted] and [redacted]

LEAD:

NEW ORLEANS DIVISION

AT SHREVEPORT, LOUISIANA

Will follow and report disposition of state  
charges against [redacted] and [redacted]

- ② - Bureau
- 2 - New Orleans
- DC/sab
- (4)

b6  
b7c

SEARCHED  
SERIALIZED  
INDEXED  
FILED  
39

REC-106

157-476

243  
59 SEP 25 1963

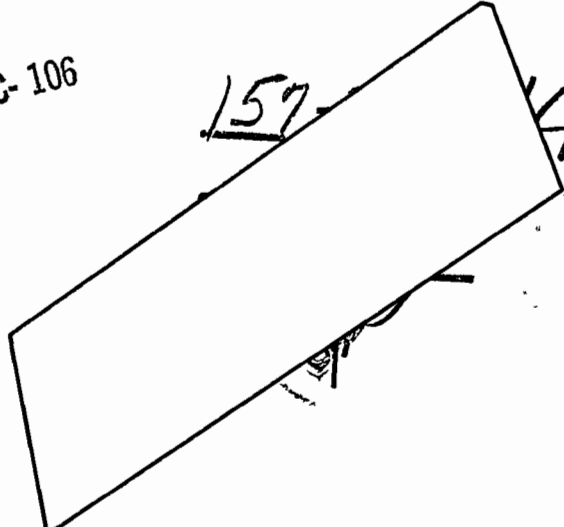

UNITED STATES GOVERNMENT

# Memorandum

TO : DIRECTOR, FBI (157-387)

DATE: 11/8/63

FROM : SAC, NEW ORLEANS (157-386) (P)

SUBJECT: FREEDOM RIDE, 1961  
Trailways Bus No. P224,  
Los Angeles, California, to  
Jackson, Mississippi  
9/9/61  
RM; CR  
OO: New Orleans

Remylet 9/17/63.

On 10/31/63 [redacted]  
First Judicial District Court, Caddo Parish, Shreveport,  
Louisiana, advised his files show no further court action  
with reference to state charges against [redacted] and  
[redacted]

b6  
b7c

LEAD

NEW ORLEANS

AT SHREVEPORT, LOUISIANA

Will follow and report disposition of state charges  
against [redacted] and [redacted]

- ② - Bureau
- 2 - New Orleans
- DC:mam
- (4)

EX-102 PROC.

REC 27 157-387-1477

6 NOV 12 1963

EX-102

337  
66 NOV 19 1963  
337

[redacted box with signature]

38

UNITED STATES GOVERNMENT

# Memorandum

TO : DIRECTOR, FBI (157-387)

DATE: 12/26/63

FROM : *[Handwritten initials]* S/C, NEW ORLEANS (157-386) (P)

7 SUBJECT: FREEDOM RIDE, 1961  
Trailways Bus No. P224,  
Los Angeles, California to  
Jackson, Mississippi  
9/9/61  
RM: CR  
OO: New Orleans

Remylet 9/17/63.

[Redacted] On December 16, 1963 [Redacted]  
[Redacted] First Judicial District Court, Caddo Parish,  
Shreveport, advised his files show no further court action  
with reference to state charges against [Redacted]  
and [Redacted]

LEAD

NEW ORLEANS DIVISION

AT SHREVEPORT, LOUISIANA:

Will follow and report disposition of state charges  
against [Redacted] and [Redacted]

- ② - Bureau
- 2 - New Orleans

DC/mrk  
(4)

REC-53

EX-112

157-387-147

6 DEC 30 1963

b6  
b7c

3 ✓

*[Vertical stamp with handwritten marks and a large 'X' over it]*

*[Handwritten signature]*

53 JAN 6 1964

UNITED STATES GOVERNMENT

# Memorandum

ALL INFORMATION CONTAINED  
HEREIN IS UNCLASSIFIED  
DATE 12-01-2009 BY 60324 UC BAW/SAB/MJS

TO : DIRECTOR, FBI (157-387)

DATE: 2/19/64

FROM : SAC, NEW ORLEANS (157-386) (P)

SUBJECT: FREEDOM RIDE, 1961  
Trailways Bus No. P224,  
Los Angeles, California, to  
Jackson, Mississippi  
9/9/61  
RM; CR  
OO: NO

Remylet, 12/26/63.

On 2/10/64

[redacted] First Judicial District Court, Caddo Parish, Shreveport,  
advised his files show no further court action with reference  
to state charges against [redacted] and [redacted]

b6  
b7C

LEAD:

NEW ORLEANS:

AT SHREVEPORT, LA.:

Will follow and report disposition of state charges  
against [redacted] and [redacted]

2-Bureau  
2-New Orleans

DC:mh  
(4)

REC 4  
EX-112

157-387-147

FEB 20 1964

EXP. PROC.

60 FEB 28 1964

F22

UNITED STATES GOVERNMENT

# Memorandum

TO : DIRECTOR, FBI (157-387) DATE: 4/28/64

FROM : *WMM/da* SAC, NEW ORLEANS (157-386) (P)

SUBJECT: FREEDOM RIDE, 1961  
Trailways Bus No. P224,  
Los Angeles, California, to  
Jackson, Mississippi  
9/9/61  
RM; CR

(OO: NEW ORLEANS)

Re New Orleans letter to Bureau, 2/19/64.

Enclosed herewith are eight copies of a letter-  
head memorandum which is self-explanatory.

Agency G-2, ONI, OSI, CRD  
Date Forw. APR 30 1964  
How Forw. R-3  
By *FPB/ler*

1 cc Org. Unit  
*1 cc destroyed*

*157-387-1480*

REC-123

EX 104

*EXP. PROC.*

- 2 - Bureau (Enc. 8)
- 2 - New Orleans

ENCLOSURE

DC:jas  
(4)

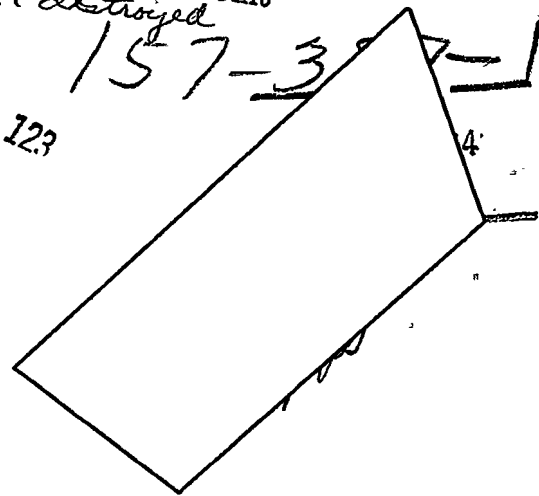

b6  
b7c

53 MAY 7 1964



UNITED STATES DEPARTMENT OF JUSTICE

FEDERAL BUREAU OF INVESTIGATION

New Orleans, Louisiana  
April 28, 1964

In Reply, Please Refer to  
File No.

FREEDOM RIDE, 1961  
Trailways Bus Number P224,  
Los Angeles, California,  
to Jackson, Mississippi  
September 9, 1961

[redacted] On April 6, 1964, [redacted]  
[redacted] First Judicial District Court, Caddo Parish,  
Shreveport, Louisiana, advised his files show no further  
court action with reference to state charges against [redacted]  
[redacted] and [redacted]

b6  
b7c

This document contains neither recommendations nor conclusions  
of the FBI. It is the property of the FBI and is loaned to  
your agency; it and its contents are not to be distributed  
outside your agency.



F B I

Date: 6/4/64

Transmit the following in \_\_\_\_\_  
(Type in plaintext or code)

Via AIRTEL AIRMAIL  
(Priority)

To: Director, FBI (157-387)

From: SAC, NEW ORLEANS (157-386) (P)

Subject: FREEDOM RIDE, 1961, Trailways  
Bus No. P224, Los Angeles, Calif.,  
to Jackson, Mississippi, 9/9/61

BOMBING MATTERS - THREATS  RACIAL MATTERS; CIVIL RIGHTS

Enclosed are eight copies of a letterhead memorandum.

*ent*  
*per*  
*trial*  
*+*

b6  
b7c

Agency G-2, ONI, OSI, CRD  
Date Forw JUN 8 1964  
How Forw RIS  
By FP5/WUP

Rec Org. Unit  
*3013 destroyed*

REC-41

157-387-1481

① - Bureau (Enclosures 8)

1 - (Field Office) New Orleans

DC: mh  
(2)

8 JUN 5 1964

ENCLOSURE

Approved: \_\_\_\_\_ Sent \_\_\_\_\_ M Per \_\_\_\_\_

Special Agent in Charge

74 JUN 15 1964

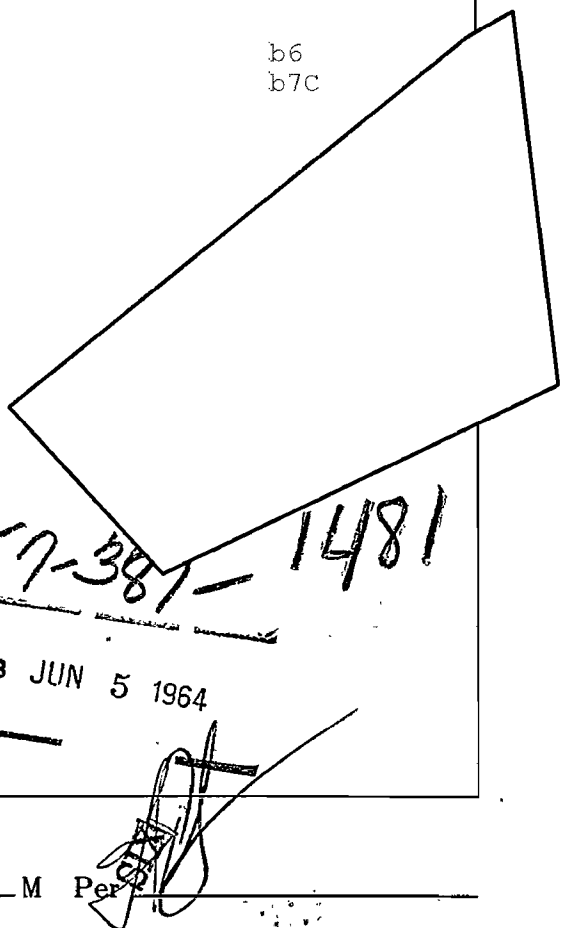



UNITED STATES DEPARTMENT OF JUSTICE  
FEDERAL BUREAU OF INVESTIGATION

In Reply, Please Refer to  
File No.

New Orleans, Louisiana  
April 28, 1964

FREEDOM RIDE, 1961  
Trailways Bus Number P224  
Los Angeles California,  
to Jackson, Mississippi,  
September 9, 1961

[redacted] On June 2, 1964, [redacted]  
[redacted] First Judicial District Court, Caddo Parish,  
Shreveport, Louisiana, advised his files show no further  
court action with reference to state charges against [redacted]  
[redacted] and [redacted]

b6  
b7C

This document contains neither recommendations nor conclusions of the FBI. It is the property of the FBI and is loaned to your agency; it and its contents are not to be distributed outside your agency.

- Mr. Tolson \_\_\_\_\_
- Mr. Belmont \_\_\_\_\_
- Mr. Mohr \_\_\_\_\_
- Mr. Casper \_\_\_\_\_
- Mr. Callahan \_\_\_\_\_
- Mr. Conrad \_\_\_\_\_
- Mr. DeLoach \_\_\_\_\_
- Mr. Evans \_\_\_\_\_
- Mr. Gale \_\_\_\_\_
- Mr. Rosen \_\_\_\_\_
- Mr. Sullivan \_\_\_\_\_
- Mr. Tavel \_\_\_\_\_
- Mr. Trotter \_\_\_\_\_
- Tele. Room \_\_\_\_\_
- Miss Holmes \_\_\_\_\_
- Miss Gandy \_\_\_\_\_

F B I

Date: 7-24-64

Transmit the following in \_\_\_\_\_  
(Type in plaintext or code)

Via AIRTEL AIRMAIL  
(Priority)

To: Director, FBI (157-387)

*H6m*  
From: SAC, NEW ORLEANS (157-386) (P)

Subject: FREEDOM RIDE, 1961  
Trailways Bus Number P224  
Los Angeles, California to Jackson, Mississippi, 9-9-61  
 BOMBING MATTERS - THREATS     RACIAL MATTERS

Enclosed are eight copies of a letterhead memorandum.



b6  
b7c

*EA*

Agency G-2, ONI, OSI, <sup>CPD</sup>  
Date Forw. JUL 27 1964  
How Forw. RS  
By FPS-JR

REC-19

EX-112

157-387-1482

RECORDED

16 JUL 28 1964

1 cc Org. Unit  
*2cc destroyed*

(1) Bureau (Enclosures 8) ENCLOSURE 8

1 - (Field Office)

DC:cj  
(2)

*D. G. Wick*

*[Handwritten signature]*

*7102*



UNITED STATES DEPARTMENT OF JUSTICE

FEDERAL BUREAU OF INVESTIGATION

In Reply, Please Refer to  
File No.

New Orleans, Louisiana  
July 24, 1964

FREEDOM RIDE, 1961  
Trailways Bus Number P224  
Los Angeles, California to  
Jackson, Mississippi

On July 1, 1964

[Redacted]

b6  
b7C

[Redacted] First Judicial District Court, Caddo Parish, Shreveport,  
Louisiana, advised his files show no further court action with  
reference to state charges against [Redacted] and  
[Redacted]

W. S. A.

This document contains neither recommendations nor conclusions  
of the FBI. It is the property of the FBI and is loaned to your  
agency; it and its contents are not to be distributed outside  
your agency.

UNITED STATES GOVERNMENT

# Memorandum

TO : DIRECTOR, FBI (157-387)

FROM : *WJM* SAC, NEW ORLEANS (157-386) (P\*)

SUBJECT: FREEDOM RIDE, 1961 Trailways  
Bus No. P224, Los Angeles,  
California, to Jackson,  
Mississippi, 9/9/61  
RM; CR  
OO: New Orleans

DATE: 8/4/64

Re New Orleans airtel, 6/4/64.

The only investigation remaining in this case is to follow state court action. In view of this this case is being made pending inactive.

- 2 - Bureau
- 1 - New Orleans

FGB/hja  
(3)

RECEIVED  
 AUG 11 1964  
 FBI - NEW ORLEANS

REC-95

157-387-1483

10  
6 AUG 6 1964

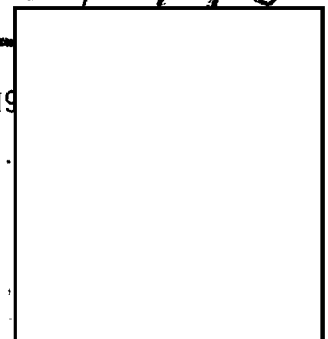

b6  
b7C

ALL INFORMATION CONTAINED  
 HEREIN IS UNCLASSIFIED

67 AUG 13 1964

UNITED STATES GOVERNMENT

# Memorandum

TO: *AKQ*  
FROM:

Director, FBI (157-387)

DATE: 9/22/64

SAC, New Orleans (157-386) (C)

SUBJECT:

FREEDOM RIDE, 1961 Trailways  
Bus No. P224, Los Angeles,  
California, to Jackson,  
Mississippi, 9/9/64  
RM; CR  
OO: New Orleans

FREEDOM RIDERS - MISCELLANEOUS

Re New Orleans letter to Bureau 8/4/64.

Inasmuch as it does not appear that state authorities  
intend to take any further action with reference to the arrest  
of  and  this matter will not  
continue to be followed by the New Orleans Division UACB.

N.S.

N.S.

- ② - Bureau
- 1 - New Orleans
- DC:mam
- (3)

*N*

b6  
b7c

*39*



REC-23

*157-387-1484*

*10-1*

25 SEP 23 1964

EX-103



RECEIVED  
FBI NEW ORLEANS

SEP 24 10 58 AM '64

*165*  
61 OCT 6 1964

# FEDERAL BUREAU OF INVESTIGATION

REPORTING OFFICE <b>NEW ORLEANS</b>	OFFICE OF ORIGIN <b>NEW ORLEANS</b>	DATE <b>10/6/64</b>	INVESTIGATIVE PERIOD <b>9/30/64</b>
TITLE OF CASE <b>FREEDOM RIDE, 1961 TRAILWAYS BUS NO. P224, LOS ANGELES, CALIFORNIA, TO JACKSON, MISSISSIPPI, SEPTEMBER 9, 1961</b>		REPORT MADE BY <b>SA [REDACTED]</b>	TYPED BY <b>lrs</b>
		CHARACTER OF CASE <b>RM; CR</b>	

REFERENCES:

New Orleans letter to Bureau, 9/22/64.

- C -

ADMINISTRATIVE:

An extra copy of this report has been prepared in event the Bureau desires copy sent to United States Attorney. No previous copies of reports have been furnished to United States Attorney, Shreveport.

b6  
b7C

APPROVED: *[Signature]* SPECIAL AGENT IN CHARGE

COPIES MADE:

- 5-Bureau (157-387)
- 2-New Orleans (157-386)

DO NOT WRITE IN SPACES BELOW

157-387-1185  
REC-45

16 OCT

EX-102

DISSEMINATION RECORD OF ATTACHED REPORT

AGENCY	CRD		
REQUEST RECD.			
DATE FWD.	10-8-64		
HOW FWD.	no		
BY	<i>[Signature]</i>		

NOTATIONS

*[Large diagonal stamp: STAT/SECT.]*

64 OCT 13 1964

UNITED STATES DEPARTMENT OF JUSTICE  
FEDERAL BUREAU OF INVESTIGATION

Copy to:

Report of: SA [REDACTED] Office: NEW ORLEANS  
 Date: 10/6/64  
 Field Office File No.: NEW ORLEANS (157-386) Bureau File No.: (157-387)  
 Title: FREEDOM RIDE, 1961  
 TRAILWAYS BUS NO. P224  
 LOS ANGELES, CALIFORNIA, TO  
 JACKSON, MISSISSIPPI,  
 SEPTEMBER 9, 1961  
 Character: RACIAL MATTERS; CIVIL RIGHTS  
 Synopsis: Records, Clerk of Court, Shreveport, La. show  
 no further action against [REDACTED] and [REDACTED]  
 [REDACTED]

b6  
b7c

- C -

DETAILS:AT SHREVEPORT, LOUISIANA

On September 30, 1964, [REDACTED]  
 First Judicial District Court, Caddo Parish, advised records  
 show no further action against [REDACTED] and [REDACTED]  
 [REDACTED]

- 1\* -



ALL INFORMATION CONTAINED  
HEREIN IS UNCLASSIFIED  
DATE 12-01-2009 BY 60324 UC EAW/SAB/MJS

*NA beam*

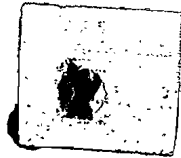

FEDERAL BUREAU OF INVESTIGATION  
U. S. DEPARTMENT OF JUSTICE  
COMMUNICATIONS SECTION  
JUL 9 1961

TELETYPE

Mr. Tolson	_____
Mr. Belmont	_____
Mr. Mohr	_____
Mr. Callahan	_____
Mr. Conrad	_____
Mr. DeLoach	_____
Mr. Evans	_____
Mr. Malone	_____
Mr. Rosen	_____
Mr. Sullivan	_____
Mr. Tavel	_____
Mr. Trotter	_____
Mr. Tele. Room	_____
Mr. Ingram	_____
Miss Gandy	_____

URGENT 7-9-61 12-17 PM CST L

TO DIRECTOR, FBI

FROM SAC NEW ORLEANS /157-264/ 1P

*Freedom Riders - Misc*

*157-387-526*

FREEBUS. RE NEW ORLEANS AIRTEL SIX TWENTYNINE LAST TRANSMITTING

LETTERHEAD MEMORANDUM CONCERNING LETTER RECEIVED FROM [REDACTED]

b6  
b7c

[REDACTED] CORE, JACKSON, MISS. [REDACTED] CONTACTED

RESIDENCE AGENCY, JACKSON, MISS., TODAY STATING HAD NOT BEEN  
CONTACTED BY U. S. DEPARTMENT OF JUSTICE CONCERNING THIS LETTER  
AND THAT HE CONTEMPLATES TELEPHONIC CONTACT WITH [REDACTED] WHO

[REDACTED] DESCRIBED AS ASSIGNED TO CIVIL RIGHTS DIVISION OF DEPARTMENT

ABOVE FOR BUREAU-S INFORMATION.

REC-7

END AND ACK PLS

WA KKK 2-17 PM OK FBI WA JDS

EX-105

JUL 11 1961

TU DISCV  
~~82 JUL 14 1961~~

OCT 7 1961  
*334*  
*pls*

*157-387-1486*  
*100-22522-424*  
*S*

Optional Form

UNITED STATES

MEMORANDUM

TO: DIRECTOR, FBI

DATE: 10/16/64

FROM: SAC, NEW ORLEANS

SUBJECT: FREEDOM RIDE, 1961  
TRAILWAYS BUS #5708 FROM  
NASHVILLE, TENN. TO JACKSON,  
MISS. 6/7/61  
RM; CR

BUFILE NO.: 157-387  
NEW ORLEANS FILE NO.: 157-291  
JACKSON FILE NO.: 157-

Due to the opening of the Jackson Office, the following changes in the above case have been made:

A. LOCATION OF FILE

- 1. ( X ) Entire file sent to Jackson Office herewith.
- 2. ( ) File sent to Jackson, except one copy of following serials retained New Orleans:
- 3. ( ) File retained New Orleans, but one copy of following serials sent to Jackson:

B. OFFICE OF ORIGIN

- ( ) NEW ORLEANS
- ( X ) JACKSON
- ( )

C. STATUS / 157-387-

- ( ) NOT RECORDED
- ( ) PENDING
- ( X ) R U OCT 21 1964
- ( X ) CLOSED

- 1 - Bureau
- 1 - Jackson
- 1 - New Orleans

ECW/bap  
(3) 61 OCT 27 1964  
374

b6  
b7c

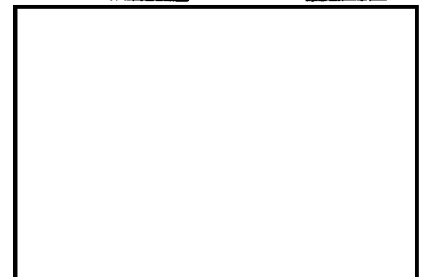

Optional Form No. 10

UNITED STATES GOVERNMENT

MEMORANDUM

TO: DIRECTOR, FBI  
FROM: ASAC, NEW ORLEANS  
SUBJECT: FREEDOM RIDE, 1961

DATE: 10/16/64

ILLINOIS CENTRAL RAILROAD  
NEW ORLEANS, LA. TO JACKSON, MISS.  
6/25/61  
RM - CR

BUFILE NO.: 157-387  
NEW ORLEANS FILE NO.: 157-318  
JACKSON FILE NO.: 157-

Due to the opening of the Jackson Office, the following changes in the above case have been made:

A. LOCATION OF FILE

1. ( X ) Entire file sent to Jackson Office herewith.
2. ( ) File sent to Jackson, except one copy of following serials retained New Orleans:
3. ( ) File retained New Orleans, but one copy of following serials sent to Jackson:

157-387

NOT RECORDED

3 OCT 21 1964

B. OFFICE OF ORIGIN

- ( ) NEW ORLEANS
- ( X ) JACKSON
- ( )

C. STATUS

- ( ) PENDING
- ( ) R U C
- ( X ) CLOSED

- ① - Bureau
- 1 - Jackson
- 1 - New Orleans

ECW/bap  
(3)

61 OCT 27 1964

b6  
b7C



Optional Form No. 10

UNITED STATES GOVERNMENT

MEMORANDUM

AA  
31

TO: DIRECTOR, FBI

DATE: 10/16/64

FROM: SAC, NEW ORLEANS

SUBJECT: FREEDOM RIDE, 1961  
ILLINOIS CENTRAL RAILROAD TRAIL #2,  
NEW ORLEANS, LA. TO JACKSON, MISS.  
10:20 AM 6/8/61  
RM; CR

BUFILE NO.: 157-387  
NEW ORLEANS FILE NO.: 157-293  
JACKSON FILE NO.: 157-

Due to the opening of the Jackson Office, the following changes in the above case have been made:

A. LOCATION OF FILE

- 1. (X) Entire file sent to Jackson Office herewith.
- 2. ( ) File sent to Jackson, except one copy of following serials retained New Orleans:
- 3. ( ) File retained New Orleans, but one copy of following serials sent to Jackson:

B. OFFICE OF ORIGIN

- ( ) NEW ORLEANS
- (X) JACKSON
- ( )

C. STATUS

- ( ) PENDING
- ( ) R U C
- (X) CLOSED

- 1 - Bureau
- 1 - Jackson
- 1 - New Orleans

ECW/bap  
(3) OCT 27 1964



b6  
b7c

ROL

Optional Form No. 10

UNITED STATES GOVERNMENT

MEMORANDUM

TO: DIRECTOR, FBI

DATE: 10/16/64

FROM: SAC, NEW ORLEANS

SUBJECT: FREEDOM RIDE, 1961  
DELTA AIRLINES FLIGHT #409  
MONTGOMERY, ALA. TO JACKSON, MISS.  
6/8/61  
RM; CR; CONTEMPT OF COURT ORDER

BUFILE NO.: 157-387  
NEW ORLEANS FILE NO.: 157-292  
JACKSON FILE NO.: 157-

Due to the opening of the Jackson Office, the following changes in the above case have been made:

A. LOCATION OF FILE

- 1. (X) Entire file sent to Jackson Office herewith.
- 2. ( ) File sent to Jackson, except one copy of following serials retained New Orleans:
- 3. ( ) File retained New Orleans, but one copy of following serials sent to Jackson:

B. OFFICE OF ORIGIN

- ( ) NEW ORLEANS
- (X) JACKSON
- ( )

C. STATUS

- ( ) PENDING
- ( ) R U C
- (X) CLOSED

157-387-  
[Redacted Box]

b6  
b7C

CONTROL

1 - Bureau  
1 - Jackson  
1 - New Orleans

ECW/bap  
(3) OCT 27 1964

374

Optional Form No. 10

UNITED STATES GOVERNMENT

M E M O R A N D U M

TO: DIRECTOR, FBI

DATE: 10/16/64

FROM: *HASAC*, NEW ORLEANS

SUBJECT: *(C)*  
FREEDOM RIDE, 1961  
TRAILW YS BUS TERMINAL  
JACKSON, MISS.  
6/23/61

BUFILE NO.: 157-387  
NEW ORLEANS FILE NO.: 157-317  
JACKSON FILE NO.: 157-

Due to the opening of the Jackson Office, the following changes in the above case have been made:

A. LOCATION OF FILE

- 1. ( X ) Entire file sent to Jackson Office herewith.
- 2. ( ) File sent to Jackson, except one copy of following serials retained New Orleans:
- 3. ( ) File retained New Orleans, but one copy of following serials sent to Jackson:

*157-387*  
NOT RECORDED  
3 OCT 21 1964

B. OFFICE OF ORIGIN

- ( ) NEW ORLEANS
- ( X ) JACKSON
- ( ) \_\_\_\_\_

C. STATUS

- ( ) PENDING
- ( ) R U C
- ( X ) CLOSED

- (1)* - Bureau
- 1 - Jackson
- 1 - New Orleans

ECW/bap  
(3)

*324*  
60 OCT 27 1964

*574*  
*SP*

Optional Form No. 10  
UNITED STATES GOVERNMENT  
M E M O R A N D U M

TO: DIRECTOR, FBI  
FROM: SAC, NEW ORLEANS  
SUBJECT: FREEDOM RIDE

DATE: 10/16/64

PS 1961  
TRAILWAYS BUS # 5141 FROM  
MONTGOMERY, ALA. TO JACKSON, MISS.  
7:00 AM TO 1:15 PM, 5/28/61  
RM; CR

BUFILE NO.:  
NEW ORLEANS FILE NO.: 157-278  
JACKSON FILE NO.: 157-

Due to the opening of the Jackson Office, the following changes in the above case have been made:

A. LOCATION OF FILE

- 1. ( X ) Entire file sent to Jackson Office herewith.
- 2. ( ) File sent to Jackson, except one copy of following serials retained New Orleans:
- 3. ( ) File retained New Orleans, but one copy of following serials sent to Jackson:

B. OFFICE OF ORIGIN

- ( ) NEW ORLEANS
- ( X ) JACKSON

C. STATUS

b6  
b7c

157-388 } - P  
                  } . R  
                  } ( X ) C  
NOT REC

3 OCT 21

1 - Bureau  
1 - Jackson  
1 - New Orleans  
ECW/bap  
(3)

68 OCT 27 1964

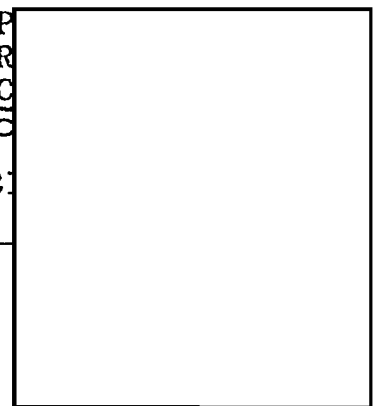

Optional Form No. 10  
UNITED STATES GOVERNMENT  
M E M O R A N D U M

TO: DIRECTOR, FBI *SI 15 (C)*  
FROM: *WJM* SAC, NEW ORLEANS  
SUBJECT: *0* FREEDOM RIDE *AS* 1961  
GREYHOUND BUS TERMINAL  
JACKSON, MISSISSIPPI  
7/7/61  
RM; CR

DATE: 10/16/64

BUFILE NO.:  
NEW ORLEANS FILE NO.: 157-330  
JACKSON FILE NO.: 157-

Due to the opening of the Jackson Office, the following changes in the above case have been made:

A. LOCATION OF FILE

- 1. ( X ) Entire file sent to Jackson Office herewith.
- 2. ( ) File sent to Jackson, except one copy of following serials retained New Orleans:
- 3. ( ) File retained New Orleans, but one copy of following serials sent to Jackson:

B. OFFICE OF ORIGIN

- ( ) NEW ORLEANS
- ( X ) JACKSON
- ( ) \_\_\_\_\_

C. STATUS | 157-337-

- ( ) PENDING ~~NOT RECORDED~~
- ( ) R U @ OCT 21 1964
- ( X ) CLOSED

① - Bureau  
1 - Jackson  
1 - New Orleans  
ECW/bap  
(3)

b6  
b7C

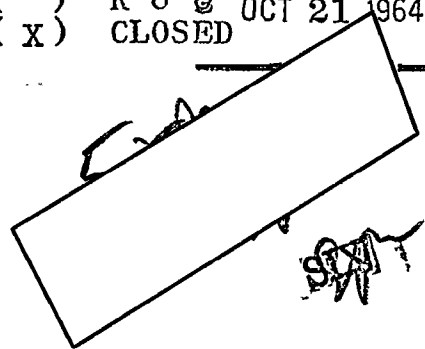

374  
8 OCT 27 1964



RA  
51

Optional Form No. 10  
UNITED STATES GOVERNMENT  
M E M O R A N D U M

TO: DIRECTOR, FBI  
FROM: SAC, NEW ORLEANS  
SUBJECT:

DATE: 10/16/64

FREEDOM RIDE, 1961  
GREYHOUND BUS #4450 FROM  
NASHVILLE, TENN. TO JACKSON,  
MISS. 5:15 PM, 5/27/61 TO 5:37 AM  
5/28/61

BUFILE NO.: RM; CR  
NEW ORLEANS FILE NO.: 157-279  
JACKSON FILE NO.: 157-

Due to the opening of the Jackson Office, the following changes in the above case have been made:

A. LOCATION OF FILE

- 1. (X) Entire file sent to Jackson Office herewith.
- 2. ( ) File sent to Jackson, except one copy of following serials retained New Orleans:
- 3. ( ) File retained New Orleans, but one copy of following serials sent to Jackson:

B. OFFICE OF ORIGIN

- ( ) NEW ORLEANS
- (X) JACKSON
- ( )

C. STATUS

- ( ) PENDING
- ( ) R U
- (X) CLO

b6  
b7c

- 1 - Bureau
- 1 - Jackson
- 1 - New Orleans

ECW/bap

(3)

68 OCT 27 1964

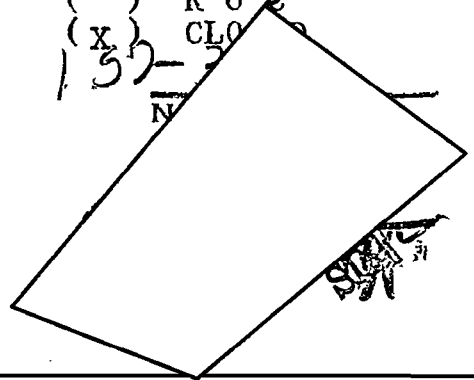

Optional Form No. 10  
UNITED STATES GOVERNMENT  
M E M O R A N D U M

TO: DIRECTOR, FBI

DATE: 10/16/64

FROM: SAC, NEW ORLEANS

SUBJECT: FREEDOM, RIDE, 1961  
TRAILWAYS BUS MONTGOMERY, ALA.  
TO JACKSON, MISS. 7/9/61  
RM

BUFILE NO.:  
NEW ORLEANS FILE NO.: 157-333  
JACKSON FILE NO.: 157-

Due to the opening of the Jackson Office, the following changes in the above case have been made:

A. LOCATION OF FILE

- 1. ( X ) Entire file sent to Jackson Office herewith.
- 2. ( ) File sent to Jackson, except one copy of following serials retained New Orleans:
- 3. ( ) File retained New Orleans, but one copy of following serials sent to Jackson:

B. OFFICE OF ORIGIN

C. STATUS

- ( ) NEW ORLEANS
- ( X ) JACKSON
- ( )

- ( ) PENDING
- ( ) R U C
- ( X ) CLOSED

157-387

① Bureau  
1 - Jackson  
1 - New Orleans  
ECW/bap  
(3)

NOT RECORDED

16 OCT 19 1964

58 OCT 22 1964

b6  
b7c

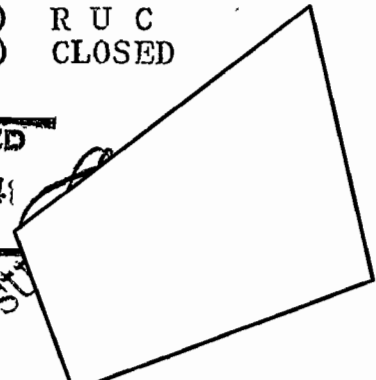

Optional Form No. 10

UNITED STATES GOVERNMENT

MEMORANDUM

TO: DIRECTOR, FBI

DATE: 10/16/64

FROM: SAC, NEW ORLEANS

SUBJECT: FREEDOM RIDE, 1961  
DELTA AIRLINES, FLIGHT #465, ST. LOUIS,  
MO. TO JACKSON, MISS. 4:49 PM CST, 6/7/61  
RM; CR

BUFILE NO.: 157-387  
NEW ORLEANS FILE NO.: 157-295  
JACKSON FILE NO.: 157-

Due to the opening of the Jackson Office, the following changes in the above case have been made:

A. LOCATION OF FILE

- 1. (X) Entire file sent to Jackson Office herewith.
- 2. ( ) File sent to Jackson, except one copy of following serials retained New Orleans:
- 3. ( ) File retained New Orleans, but one copy of following serials sent to Jackson:

B. OFFICE OF ORIGIN

- ( ) NEW ORLEANS
- (X) JACKSON
- ( ) \_\_\_\_\_

C. STATUS

- ( ) PENDING
- ( ) R U C
- (X) CLOSED

b6  
b7c

- ① Bureau
- 1 -- Jackson
- 1 -- New Orleans

ECW/bap

(3) 61 OCT 21 1964

157-387-550  
NOT RECORDED  
16 OCT 1964

Optional Form No. 10

UNITED STATES GOVERNMENT

MEMORANDUM

TO: DIRECTOR, FBI

DATE: 10/15/64

FROM: SAC, NEW ORLEANS

*Freedom Riders*

SUBJECT: DISCRIMINATION IN TRANSPORTATION;  
ILLINOIS CENTRAL RAILROAD, ILL.  
CENTRAL RAILROAD TERMINAL, JACKSON, MISS.  
CR; RM

*st  
pc*

BUFILE NO.:  
NEW ORLEANS FILE NO.: 157-507  
JACKSON FILE NO.: 157-

Due to the opening of the Jackson Office, the following changes in the above case have been made:

A. LOCATION OF FILE

- 1. ( X ) Entire file sent to Jackson Office herewith.
- 2. ( ) File sent to Jackson, except one copy of following serials retained New Orleans:
- 3. ( ) File retained New Orleans, but one copy of following serials sent to Jackson:

B. OFFICE OF ORIGIN

- ( ) NEW ORLEANS
- ( X ) JACKSON
- ( )

C. STATUS

- ( ) PENDING
- ( ) R U C
- ( X ) CLOS

b6  
b7C

① - Bureau  
1 - Jackson  
1 - New Orleans  
ECW/bap

66 OCT 22 1964

157-387-  
NOT RECORDED

16 OCT 19 1964

REC'D - CIV RIGHTS

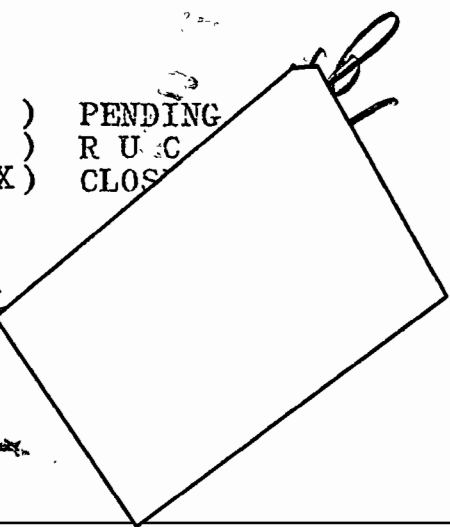

Optional Form No. 20

UNITED STATES GOVERNMENT

MEMORANDUM

TO: DIRECTOR, FBI  
FROM: SAC, NEW ORLEANS  
SUBJECT: *MM*  
*MM*

DATE: 10/15/64

*pr*  
FREEDOM RIDER, 1961,  
DELTA AIRLINES FLIGHT #411  
MONTGOMERY, ALA., TO JACKSON, MISS.  
7/24/61  
RM; CR

BUFILE NO.:  
NEW ORLEANS FILE NO.: 157-355  
JACKSON FILE NO.: 157-

Due to the opening of the Jackson Office, the following changes in the above case have been made:

A. LOCATION OF FILE

- 1. ( X ) Entire file sent to Jackson Office herewith.
- 2. ( ) File sent to Jackson, except one copy of following serials retained New Orleans:
- 3. ( ) File retained New Orleans, but one copy of following serials sent to Jackson:

B. OFFICE OF ORIGIN

- ( ) NEW ORLEANS
- ( X ) JACKSON
- ( ) \_\_\_\_\_

C. STATUS

- ( ) PENDING
- ( ) R U C
- ( X ) CLOSED *5*

- ① - Bureau
- 1 - Jackson
- 1 - New Orleans

ECW/bap

66 OCT 22 1964

157-387  
NOT RECORDED  
16 OCT 19 1964



b6  
b7c

Optional Form No. 10

UNITED STATES GOVERNMENT

MEMORANDUM

TO: DIRECTOR, FBI

DATE: 10/15/64

FROM: SAC, NEW ORLEANS

SUBJECT: FREEDOM RIDE, 1961  
ILLINOIS CENTRAL RAILROAD,  
NEW ORLEANS, LA. TO JACKSON,  
MISS. 7/30/61  
RM; CR

BUFILE NO.: ~~157-385~~ 157-387 0-17 NO (13a)  
NEW ORLEANS FILE NO.: 157-342 11-2-64 *aka*  
JACKSON FILE NO.: 157- 0-7 JN *Beary*

Due to the opening of the Jackson Office, the following changes in the above case have been made:

A. LOCATION OF FILE

1. (X) Entire file sent to Jackson Office herewith.
2. ( ) File sent to Jackson, except one copy of following serials retained New Orleans:
3. ( ) File retained New Orleans, but one copy of following serials sent to Jackson:

B. OFFICE OF ORIGIN

- ( ) NEW ORLEANS
- (X) JACKSON
- ( )

C. STATUS

- ( ) PENDING
- (X) R. U C
- (X) CLOSED

- 1 Bureau
- 1 - Jackson
- 1 - New Orleans

ECW/bap  
(3) ~~61~~ OCT 21 1964

157-387-  
~~157-385~~  
NOT RECORDED  
16 OCT 19 1964

*Handwritten signature and initials*

b6  
b7c

NOV 2-1964 *Handwritten initials*

UNITED STATES GOVERNMENT

MEMORANDUM

TO: DIRECTOR, FBI  
FROM: SAC, NEW ORLEANS  
SUBJECT: FREEDOM RIDE, 1961  
DANIEL RAY THOMPSON, GREYHOUND  
BUS TERMINAL, JACKSON, MISS.  
6/14/61  
RM; CR

DATE: 10/16/64

*AB*  
*ST*

0

*FREEDOM RIDERS - MISC.*

BUFILE NO.: 157-387  
NEW ORLEANS FILE NO.: ~~157-304~~  
JACKSON FILE NO.: 157-

Due to the opening of the Jackson Office, the following changes in the above case have been made:

A. LOCATION OF FILE

- 1. ( X ) Entire file sent to Jackson Office herewith.
- 2. ( ) File sent to Jackson, except one copy of following serials retained New Orleans:
- 3. ( ) File retained New Orleans, but one copy of following serials sent to Jackson:

b6  
b7C

B. OFFICE OF ORIGIN

- ( ) NEW ORLEANS
- ( X ) JACKSON
- ( ) \_\_\_\_\_

C. STATUS

- ( ) PENDING
- ( ) R U C
- ( X ) CLOSED

*500*

*157-387-*

NOT RECORDED

16 OCT 19 1964

- ① - Bureau
- 1 - Jackson
- 1 - New Orleans

ECW/bap  
(3)

*375*

64 OCT 21 1964

Optional Form No. 10  
UNITED STATES GOVERNMENT  
M E M O R A N D U M

TO: DIRECTOR, FBI  
FROM: *NM* SAC, NEW ORLEANS  
SUBJECT: FREEDOM RIDE, 1961  
GREYHOUND BUS NASHVILLE,  
TENN. TO JACKSON, MISS. 6/10/61  
RM; CR

DATE: 10/16/64

*BT  
ST*

*○ FREEDOM RIDERS - MISC.*

BUFILE NO.: 157-387  
NEW ORLEANS FILE NO.: 157-299  
JACKSON FILE NO.: 157-

Due to the opening of the Jackson Office, the following changes in the above case have been made:

A. LOCATION OF FILE

1. (X) Entire file sent to Jackson Office herewith.
2. ( ) File sent to Jackson, except one copy of following serials retained New Orleans:
3. ( ) File retained New Orleans, but one copy of following serials sent to Jackson:

B. OFFICE OF ORIGIN

- ( ) NEW ORLEANS
- (X) JACKSON
- ( )

C. STATUS

- ( ) PENDING
- ( ) R U C
- (X) CLOSED

*[Handwritten signature]*

- ① - Bureau
- 1 - Jackson
- 1 - New Orleans

ECW/bap

(3) *375*

64 OCT 21 1964

*157-387*

NOT RECORDED

OCT 19 1964

b6  
b7c





Optional Form No. 10

UNITED STATES GOVERNMENT

M E M O R A N D U M

TO: DIRECTOR, FBI

DATE: 10/16/64

FROM: SAC, NEW ORLEANS

SUBJECT: FREEDOM RIDE, 1961  
TRAILWAYS BUS MONTGOMERY, ALA.  
TO JACKSON, MISS. 7/2/61  
RM; CR

AB  
ST

○ FREEDOM RIDERS - misc.

BUFILE NO.: 157-387  
NEW ORLEANS FILE NO.: 157-322  
JACKSON FILE NO.: 157-

Due to the opening of the Jackson Office, the following changes in the above case have been made:

A. LOCATION OF FILE

- 1. ( X ) Entire file sent to Jackson Office herewith.
- 2. ( ) File sent to Jackson, except one copy of following serials retained New Orleans:
- 3. ( ) File retained New Orleans, but one copy of following serials sent to Jackson:

B. OFFICE OF ORIGIN

C. STATUS

- ( ) NEW ORLEANS
- ( X ) JACKSON
- ( )

- ( ) PENDING
- ( ) R U C
- ( X ) CLOSED

b6  
b7c

*[Handwritten signature]*

- ① - Bureau
- 1 - Jackson
- 1 - New Orleans

ECW/bap

(3)

375

157-387-

NOT RECORDED

16 OCT 19 1964



64 OCT 21 1964

Optional Form No. 10  
UNITED STATES GOVERNMENT  
MEMORANDUM

TO: DIRECTOR, FBI  
FROM: SAC, NEW ORLEANS

DATE: 10/16/64

SUBJECT: FREEDOMRIDE, 1961, ILLINOIS  
CENTRAL RAILROAD, TRAIL #205,  
NASHVILLE, TENN. TO JACKSON, MISS.  
5:30 AM, 6/9/61  
RM; CR

0 FREEDOM RIDERS - MISC.

BUFILE NO.: 157-387  
NEW ORLEANS FILE NO.: 157-296  
JACKSON FILE NO.: 157-

Due to the opening of the Jackson Office, the following changes in the above case have been made:

A. LOCATION OF FILE

- 1. ( X ) Entire file sent to Jackson Office herewith.
- 2. ( ) File sent to Jackson, except one copy of following serials retained New Orleans:
- 3. ( ) File retained New Orleans, but one copy of following serials sent to Jackson:

B. OFFICE OF ORIGIN

C. STATUS

( ) NEW ORLEANS  
 ( X ) JACKSON  
 ( )

( ) PENDING  
 ( ) R U C  
 ( X ) CLOSED

b6  
b7c

- ① - Bureau
- 1 - Jackson
- 1 - New Orleans

ECW/bap

(3)

64 OCT 21 1964

NOT RECORDED

157-387-  
OCT 19 1964



*Handwritten signature*

Optional Form No. 10  
UNITED STATES GOVERNMENT  
M E M O R A N D U M

ALL INFORMATION CONTAINED  
HEREIN IS UNCLASSIFIED  
DATE 12-01-2009 BY 60324 UC BAW/SAB/MJS

TO: DIRECTOR, FBI  
FROM: SAC, NEW ORLEANS  
SUBJECT: FREEDOM RIDE, 1961  
TRAILWAYS BUS #5131  
NEW ORLEANS, LA. TO JACKSON, MISS.  
6/6/61  
RM; CR

DATE: 10/16/64

BUFILE NO.: 157-387  
NEW ORLEANS FILE NO.: 157-288  
JACKSON FILE NO.: 157-

Due to the opening of the Jackson Office, the following changes in the above case have been made:

A. LOCATION OF FILE

1. (X) Entire file sent to Jackson Office herewith.
2. ( ) File sent to Jackson, except one copy of following serials retained New Orleans:
3. ( ) File retained New Orleans, but one copy of following serials sent to Jackson:

B. OFFICE OF ORIGIN

( ) NEW ORLEANS  
(X) JACKSON  
( )

C. STATUS

( ) PENDING  
( ) R U C  
(X) CLOSED

1 - Bureau  
1 - Jackson  
1 - New Orleans  
ECW/bap  
(3)

NOT RECORDED

157-387-  
16 OCT 19 1964

b6  
b7c

64 OCT 21 1964

Optional Form No. 10  
UNITED STATES GOVERNMENT  
M E M O R A N D U M

ALL INFORMATION CONTAINED  
HEREIN IS UNCLASSIFIED  
DATE 12-01-2009 BY 60324 UC BAW/SAB/MJS

TO: DIRECTOR, FBI  
FROM: *HJM* SAC, NEW ORLEANS  
SUBJECT: *JMO* FREEDOM RIDE, 1961  
ILLINOIS CENTRAL RAILROAD, NEW ORLEANS  
LA. TO JACKSON, MISS. 6/20/61  
RM; CR

DATE: 10/16/64

*fb*  
BUFILE NO.: 157-387  
NEW ORLEANS FILE NO.: 157-310  
JACKSON FILE NO.: 157-

Due to the opening of the Jackson Office, the following changes in the above case have been made:

A. LOCATION OF FILE

- 1. ( X ) Entire file sent to Jackson Office herewith.
- 2. ( ) File sent to Jackson, except one copy of following serials retained New Orleans:
- 3. ( ) File retained New Orleans, but one copy of following serials sent to Jackson:

B. OFFICE OF ORIGIN

( ) NEW ORLEANS  
 ( X ) JACKSON  
 ( )

C. STATUS

( ) PENDING  
 ( X ) R U C  
 ( ) CLOSED

*500*

*157-387-*

1 - Bureau  
 1 - Jackson  
 1 - New Orleans  
 ECW/bap  
 (3) *37-37*

NOT RECORDED  
 16 OCT 19 1964

6 OCT 21 1964

b6  
b7c

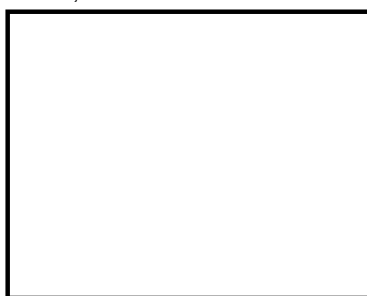

Optional Form No. 10

UNITED STATES GOVERNMENT

MEMORANDUM

TO: DIRECTOR, FBI  
FROM: SAC, NEW ORLEANS  
SUBJECT: FREEDOM RIDE, 1961

DATE: 10/16/64

GREYHOUND BUS M4446 NASHVILLE,  
TENN. TO JACKSON, MISS. 6/11/61  
RM; CR

BUFILE NO.: 157-387  
NEW ORLEANS FILE NO.: 157-301  
JACKSON FILE NO.: 157-

Due to the opening of the Jackson Office, the following changes in the above case have been made:

A. LOCATION OF FILE

- 1. ( X ) Entire file sent to Jackson Office herewith.
- 2. ( ) File sent to Jackson, except one copy of following serials retained New Orleans:
- 3. ( ) File retained New Orleans, but one copy of following serials sent to Jackson:

B. OFFICE OF ORIGIN

- ( ) NEW ORLEANS
- ( X ) JACKSON
- ( )

C. STATUS

- ( ) PENDING
- ( ) R U G
- ( X ) CLOSED

1 - Bureau  
1 - Jackson  
1 - New Orleans  
ECW/bap  
(3)

157-387-

NOT RECORDED

OCT 19 1964

b6  
b7C

60 OCT 21 1964

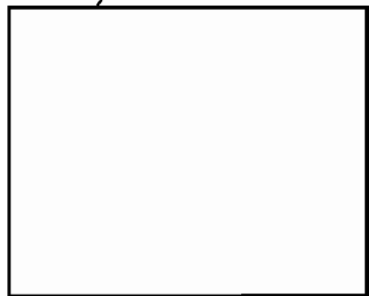

Optional Form No. 10  
UNITED STATES GOVERNMENT  
M E M O R A N D U M

ALL INFORMATION CONTAINED  
HEREIN IS UNCLASSIFIED  
DATE 12-01-2009 BY 60324 UC BAW/SAB/MJS

TO: DIRECTOR, FBI

DATE: 10/16/64

FROM: SAC, NEW ORLEANS

SUBJECT:

FREEDOM RIDE, 1961  
MICHAEL JAMES AUDAIN, GREYHOUND BUS  
TERMINAL, JACKSON, MISS. 6:00 PM,  
6/7/61  
RM; CR

BUFILE NO.: 157-387  
NEW ORLEANS FILE NO.: 157-298  
JACKSON FILE NO.: 157-

*0 FREEDOM RIDERS-MISC.*

Due to the opening of the Jackson Office, the following changes in the above case have been made:

A. LOCATION OF FILE

- 1. (X) Entire file sent to Jackson Office herewith.
- 2. ( ) File sent to Jackson, except one copy of following serials retained New Orleans:
- 3. ( ) File retained New Orleans, but one copy of following serials sent to Jackson:

B. OFFICE OF ORIGIN

C. STATUS

( ) NEW ORLEANS  
 (X) JACKSON  
 ( )

( ) PENDING  
 ( ) R U C  
 (X) CLOSED

b6  
b7C

1 - Bureau  
1 - Jackson  
1 - New Orleans

*157-387-*

NOT RECORDED  
16 OCT 19 1964

ECW/bap 375  
64 OCT 21 1964

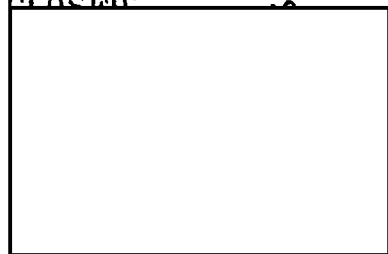

Optional Form No. 10  
UNITED STATES GOVERNMENT  
M E M O R A N D U M

ALL INFORMATION CONTAINED  
HEREIN IS UNCLASSIFIED  
DATE 12-01-2009 BY 60324 UC BAW/SAB/MJS

TO: DIRECTOR, FBI

DATE: 10/15/64

FROM: SAC, NEW ORLEANS

SUBJECT: FREEDOM RIDE, 1961,  
TRAILWAYS BUS NEW ORLEANS, LA.  
TO JACKSON, MISS. 8/13/61  
RM;CR

BUFILE NO.: 157-387  
NEW ORLEANS FILE NO.: 157-367  
JACKSON FILE NO.: 157-

Due to the opening of the Jackson Office, the following changes in the above case have been made:

A. LOCATION OF FILE

- 1. ( X ) Entire file sent to Jackson Office herewith.
- 2. ( ) File sent to Jackson, except one copy of following serials retained New Orleans:
- 3. ( ) File retained New Orleans, but one copy of following serials sent to Jackson:

B. OFFICE OF ORIGIN

C. STATUS

- ( ) NEW ORLEANS
- ( X ) JACKSON
- ( )

- ( ) PENDING
- ( ) R U C
- ( X ) CLOSED

b6  
b7C

- ① - Bureau
- 1 - Jackson
- 1 - New Orleans

ECW/bap  
(3) *375*  
60 OCT 21 1964

157-387-  
NOT RECORDED  
16 OCT 19 1964

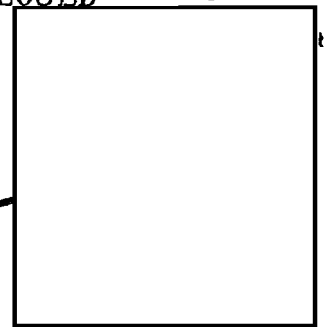

Optional Form No. 10  
UNITED STATES GOVERNMENT  
M E M O R A N D U M

ALL INFORMATION CONTAINED  
HEREIN IS UNCLASSIFIED  
DATE 12-01-2009 BY 60324 UC BAW/SAB/MJS

TO: DIRECTOR, FBI

DATE: 10/15/64

FROM: SAC, NEW ORLEANS

SUBJECT: FREEDOM RIDE, 1961  
TRAILWAYS BUS NO. P224, LOS  
ANGELES, CALIF., TO JACKSON,  
MISS. 9/9/61  
RM; CR

BUFILE NO.: ~~105-387~~  
NEW ORLEANS FILE NO.: 157-386  
JACKSON FILE NO.: 157-

Due to the opening of the Jackson Office, the following changes in the above case have been made:

A. LOCATION OF FILE

1. (X) Entire file sent to Jackson Office herewith.
2. ( ) File sent to Jackson, except one copy of following serials retained New Orleans:
3. ( ) File retained New Orleans, but one copy of following serials sent to Jackson:

B. OFFICE OF ORIGIN

- ( ) NEW ORLEANS
- (X) JACKSON
- ( )

C. STATUS

- ( ) PENDING
- ( ) R U C
- (X) CLOSED

b6  
b7c

1 - Bureau  
1 - Jackson  
1 - New Orleans  
ECW/bap  
(3)

157-387-

NOT RECORDED  
16 OCT 19 1964

60 OCT 21 1964

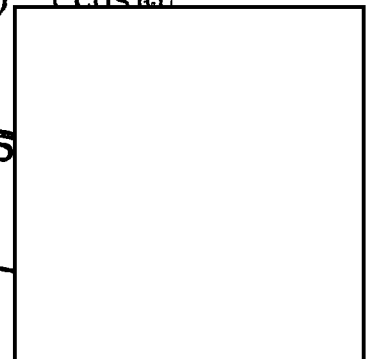



Optional Form No. 10  
UNITED STATES GOVERNMENT  
M E M O R A N D U M

ALL INFORMATION CONTAINED  
HEREIN IS UNCLASSIFIED  
DATE 12-01-2009 BY 60324 UC BAW/SAB/MJS

TO: DIRECTOR, FBI  
FROM: SAC, NEW ORLEANS  
SUBJECT: FREEDOM RIDE, 1961

DATE: 10/15/64

GREYHOUND BUS, NASHVILLE,  
TENN. TO JACKSON, MISS, 7/21/61  
RM; CR

BUFILE NO.: 157-387  
NEW ORLEANS FILE NO.: 157-351  
JACKSON FILE NO.: 157-

Due to the opening of the Jackson Office, the following changes in the above case have been made:

A. LOCATION OF FILE

1. ( X ) Entire file sent to Jackson Office herewith.
2. ( ) File sent to Jackson, except one copy of following serials retained New Orleans:
3. ( ) File retained New Orleans, but one copy of following serials sent to Jackson:

B. OFFICE OF ORIGIN

( ) NEW ORLEANS  
( X ) JACKSON

C. STATUS

( ) PENDING  
( ) R U C  
( X ) CLOSED

157-387-

b6  
b7c

5 CAB

- 1 - Bureau  
1 - Jackson  
1 - New Orleans

ECW/bap

(3)

375  
OCT 21 1964

NOT RECORDED  
16 OCT 19 1964

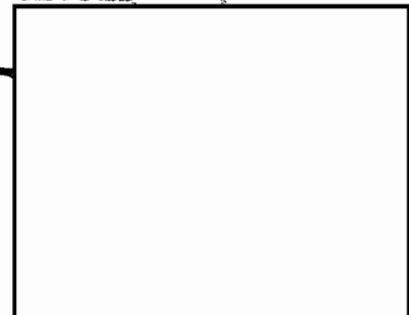

UNITED STATES GOVERNMENT

MEMORANDUM

TO: DIRECTOR, FBI

DATE: 10/15/64

FROM: SAC, NEW ORLEANS

SUBJECT: FREEDOM RIDE, 1961  
GREYHOUND BUS, NASHVILLE,  
TENN. TO JACKSON, MISS. 7/29/61  
RM; CR

BUFILE NO.: 157-387  
NEW ORLEANS FILE NO.: 157-358  
JACKSON FILE NO.: 157-

Due to the opening of the Jackson Office, the following changes in the above case have been made:

A. LOCATION OF FILE

- 1. (X) Entire file sent to Jackson Office herewith.
- 2. ( ) File sent to Jackson, except one copy of following serials retained New Orleans:
- 3. ( ) File retained New Orleans, but one copy of following serials sent to Jackson:

B. OFFICE OF ORIGIN

- ( ) NEW ORLEANS
- (X) JACKSON
- ( ) \_\_\_\_\_

C. STATUS

- ( ) PENDING
- ( ) R U C
- (X) CLOSED

- 1 - Bureau
- 1 - Jackson
- 1 - New Orleans

ECW/bap

31 OCT 21 1964

157-387  
NOT RECORDED  
16 OCT 19 1964

b6  
b7c

st  
pc

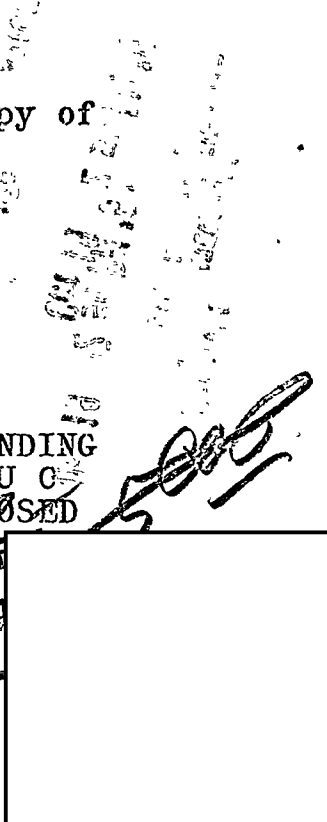

Optional Form N 10  
UNITED STATES GOVERNMENT  
M E M O R A N D U M

ALL INFORMATION CONTAINED  
HEREIN IS UNCLASSIFIED  
DATE 12-01-2009 BY 60324 UC BAW/SAB/MJS

TO: DIRECTOR, FBI  
FROM: SAC, NEW ORLEANS

DATE: 10/15/64

SUBJECT: FREEDOM RIDE 1961;  
JAMES ROBERT WAHLSTROM;  
GREYHOUND BUS TERMINAL;  
JACKSON, MISS. 7/31/61

BUFILE NO.: 157-387-1012  
NEW ORLEANS FILE NO.: 157-360  
JACKSON FILE NO.: 157-

Due to the opening of the Jackson Office, the following changes in the above case have been made:

A. LOCATION OF FILE

- 1. (X) Entire file sent to Jackson Office herewith.
- 2. ( ) File sent to Jackson, except one copy of following serials retained New Orleans:
- 3. ( ) File retained New Orleans, but one copy of following serials sent to Jackson:

B. OFFICE OF ORIGIN

- (X) NEW ORLEANS
- ( ) JACKSON

C. STATUS

- ( ) PENDING
- ( ) R U C
- (X) CLOSED

b6  
b7C

1 - Bureau  
1 - Jackson  
ECW/bap  
(3)

26 OCT 20 1964

157-387-  
OCT 17 1964  
NOT RECORDED  
OCT 16 1964

UNITED STATES GOVERNMENT

# Memorandum

ALL INFORMATION CONTAINED  
HEREIN IS UNCLASSIFIED  
DATE 12-01-2009 BY 60324 UC BAW/SAB/MJS

TO : Director, FBI

DATE: 11/11/76

FROM : SAC, CINCINNATI (157-6376) (P)

SUBJECT: [Redacted] Aka.,

[Redacted]  
Freedom Riders - Misc.

Columbus, Ohio  
EM - URBAN GUERRILLA WARFARE  
(OO: CI)

Preliminary investigation has been initiated on the following  organization  individual and a search of FBIHQ files is requested:

Name/Aliases	<u>[Redacted]</u>	Birth date	<u>[Redacted]</u>	Birthplace	Unknown
Residence	<u>[Redacted]</u>				
Employment	Unknown				

b6  
b7c

Description	Other	hair	SSAN	<u>[Redacted]</u>
Sex <u>M</u>	Race <u>[Redacted]</u>	eyes	Lima, Ohio PD	<u>[Redacted]</u>

Basic Allegation

This investigation is based on information that [Redacted] may be engaged in activities which involve or will involve the use of force or violence or which involve or will involve the violation of federal law, for the purpose of substantially impairing the function of the government in order to influence (cont.)

FOR USE ONLY OF FBIHQ

Bufile # \_\_\_\_\_

- Bufiles negative
- Bufiles contain no information not in your possession
- Insufficient information on which to base search
- Bufiles identifiable information
- Attached  Will follow
- FBIHQ concurs with Field action
- No basis to investigate; close case

Remarks:

*NR* *DE-13* *REC-13*  
see Bureau airtel 157-387-1487  
CI 12/6/76

NOV 17 1976



2 Bureau  
2- Cincinnati  
JRC:llc 11/1977  
(4)

CI 157-6376

U.S. Government policies or decisions.

[redacted] is [redacted]  
[redacted] and [redacted]  
[redacted] allegedly controls a small stockpile of explosives  
and automatic weapons at unknown location in Lima, Ohio.  
Two Columbus, Ohio police departments have been bombed and  
"Freedom Riders" members are possible suspects in these as  
well as at least one unsolved murder in Madison County, Ohio.

b6  
b7C



023

ALL INFORMATION CONTAINED  
HEREIN IS UNCLASSIFIED  
DATE 12-01-2009 BY 60324 UC BAW/SAB/MJS

1 2

4/14/82

UNCLAS

ROUTINE

#F023ERR OCIDE HQ H0023 #H4YU8R 141647Z AOR\*\*APR 82

FM DIRECTOR FBI (157-387 SERIALS 1050, 1193, 462, 683 AND 1357)  
TO FBI OKLAHOMA CITY (62D-4323) ROUTINE

BT

UNCLAS

*Freedom Riders - Mississippis*

[Redacted] AKA [Redacted] [Redacted] [Redacted]  
[Redacted] DOMESTIC POLICE COOPERATION; 00: 0C

REURTELETYPE DATED 4/8/82.

A REVIEW OF BUREAU INDICES REVEAL THAT ONE [Redacted]

[Redacted] DATE OF BIRTH [Redacted] WAS INVOLVED IN A CIVIL  
UNREST CASE WITH OKLAHOMA CITY AS OFFICE OF ORIGIN, YOUR FILE  
157-82, ENTITLED "FREEDOM RIDE, 1961; GREYHOUND BUS NUMBER 4290;  
NASHVILLE, TENNESSEE TO JACKSON, MISSISSIPPI; JUNE 16, 1961.

b6  
b7c

[Redacted] WAS ARRESTED 6/16/61 IN JACKSON, MISSISSIPPI FOR BREACH OF  
THE PEACE AND WAS SENTENCED TO FOUR MONTHS IN JAIL SUSPENDED AND  
A \$200.00 FINE.

OKLAHOMA CITY LETTER AND LHM DATED 10/19/61 ALSO REVEAL  
THAT [Redacted] OF STILLWATER, OKLAHOMA WAS ARRESTED MAY 11,

CLP: SJ (4) 4/14/82 5064 4245

1 [Redacted]  
1 [Redacted]  
1 [Redacted]

V-30  
DE-42

157-387-1488

FEDERAL BUREAU OF INVESTIGATION  
COMMUNICATIONS CENTER

15 APR 15 1982

124  
59 MAY 14 1982

03582  
APR 15 1982

DO NOT FILE WITHOUT COMMUNICATIONS STAMP

DEPARTMENT OF JUSTICE  
FEDERAL BUREAU OF INVESTIGATION  
COMMUNICATION MESSAGE FORM

PAGE 2

CONTINUATION SHEET

PAGE TWO DE HQ 0023 UNCLAS

1959 FOR RECKLESS DRIVING AND WAS FINED \$10.00.

BUREAU FILES CONTAIN NO OTHER INFORMATION IDENTIFIABLE  
WITH CAPTIONED SUBJECT.

BT

|

DO NOT TYPE PAST THIS LINE

DO NOT TYPE PAST THIS LINE