

FEDERAL BUREAU OF INVESTIGATION  
FOI/PA  
DELETED PAGE INFORMATION SHEET  
FOI/PA# 1362425-000

Total Deleted Page(s) = 26

- Page 3 ~ Duplicate;
- Page 4 ~ Duplicate;
- Page 5 ~ Duplicate;
- Page 6 ~ Duplicate;
- Page 7 ~ Duplicate;
- Page 10 ~ Duplicate;
- Page 11 ~ Duplicate;
- Page 12 ~ Duplicate;
- Page 14 ~ Duplicate;
- Page 15 ~ Duplicate;
- Page 18 ~ Duplicate;
- Page 19 ~ Duplicate;
- Page 27 ~ Duplicate;
- Page 28 ~ Duplicate;
- Page 29 ~ Duplicate;
- Page 30 ~ Duplicate;
- Page 31 ~ Duplicate;
- Page 32 ~ Duplicate;
- Page 35 ~ Duplicate;
- Page 36 ~ Duplicate;
- Page 37 ~ Duplicate;
- Page 38 ~ Duplicate;
- Page 39 ~ Duplicate;
- Page 40 ~ Duplicate;
- Page 41 ~ Duplicate;
- Page 42 ~ Duplicate;

XXXXXXXXXXXXXXXXXXXXXXXXXXXX  
X Deleted Page(s) X  
X No Duplication Fee X  
X For this Page X  
XXXXXXXXXXXXXXXXXXXXXXXXXXXX

048

b6  
b7c

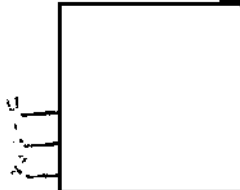

MESSAGE RELAY VIA TELETYPE

DATE 7/10/80	CLASSIFICATION <del>CONFIDENTIAL</del>	PRECEDENCE Priority
-----------------	---	------------------------

FM DIRECTOR FBI

TO

FEDERAL GOVERNMENT

b3  
b7E

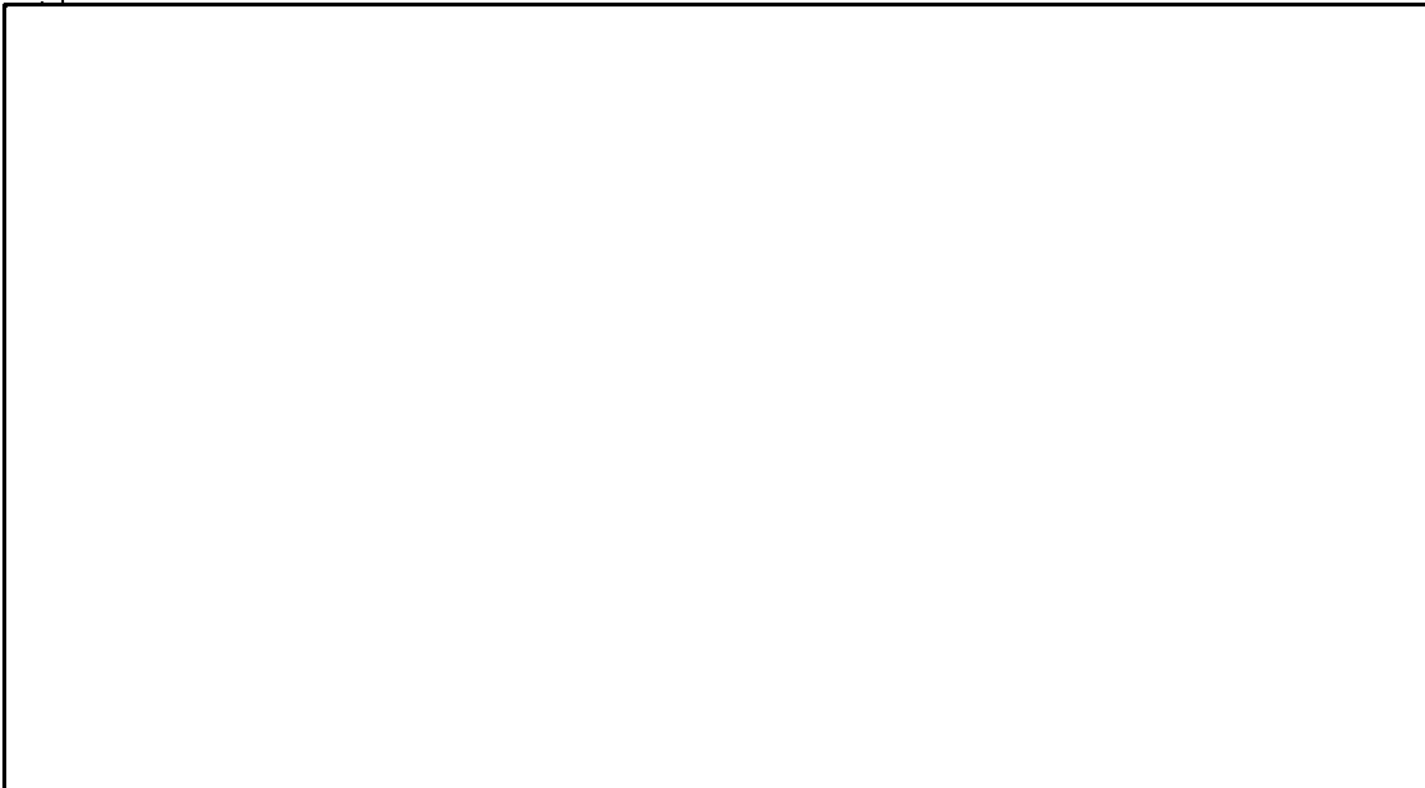

(SERVICE ALSO AVAILABLE TO GOVERNMENT AGENCIES NOT LISTED.  
CONTACT COMMUNICATIONS CENTER FOR ADDRESSING INFORMATION)

SUBJECT:

SEE ATTACHED

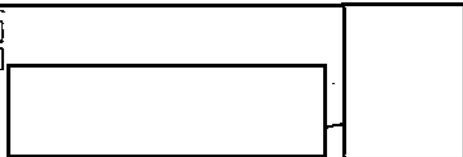

b3  
b7E

2 JUL 21 1980

ORIGINATOR	ROOM	TELE EXT.
[redacted]	4045	4660

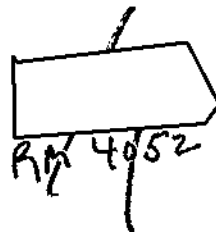
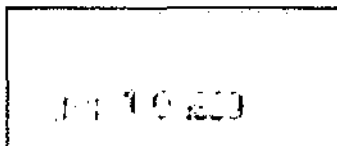

b6  
b7c

DO NOT FILE WITHOUT COMMUNICATIONS STAMP

## USE OF FORM 0-73

1. Only incoming teletype messages which require transmission relay may be prepared for transmission using form 0-73. Use of form 0-73 is restricted to incoming teletype messages received within the last 3 days which require transmission relay; all other teletype messages must be prepared using form 0-93.
2. Additions such as notes and administrative data for a specific addressee are not allowed. If a note or administrative data is required for a particular addressee a separate 0-73 form must be prepared.
3. The message will be transmitted just as it appears. The person approving the message is solely responsible for assuring all necessary editing changes have been made.

### PREPARATION OF FORM WHICH CONSISTS OF A PREPRINTED YELLOW.

1. Complete appropriate boxes: date, classification & precedence.
2. List addresses immediately following the "TO" or place a check mark in the appropriate boxes.
3. Type or PRINT the subject in the space provided.
4. Print or type originator's name, room number and telephone extension.
5. Indicate approval for transmission by initialing the "Approved By" box.

COMMON  
CL 1  
FEB 1 1960

10 JUL 60

### PREPARATION OF MESSAGE TO BE TRANSMITTED

1. Xerox 1 copy of incoming teletype message. A notation shall be made on the original incoming teletype "1 copy made for relay to SACS \_\_\_\_\_, (OR LEGATS) \_\_\_\_\_, (OR GOVERNMENT AGENCIES) \_\_\_\_\_."
2. Minor editing changes shall be made on the xerox as follows: using a lead pencil ONLY draw single line through the first and last lines of the heading and connect these lines from top right to bottom left forming a "Z," figure. (DO NOT OBLITERATE THE HEADING.) Use horizontal lines to delete sentences or words. Printed changes of a word or two to the text of the message may be made; however, changes to the existing text involving more than a word or two necessitate the originator to initiate a new message using form 0-93.
3. Administrative data or notes may be typed immediately following the text and will be transmitted to all addressees.
4. When using the 0-73 form to disseminate information to field offices, Legal Attaches and other Government agencies simultaneously, the text, notes and administrative data must be identical for all addressees.

1  
1  
1  
1

Assistant Attorney General  
Criminal Division

July 9, 1980

Director, FBI

b3  
b6  
b7C  
b7E

FEDERAL GOVERNMENT

PLOT TO ASSASSINATE CUBAN  
PRESIDENT FIDEL CASTRO  
DURING PLANNED VISIT TO  
NICARAGUA JULY, 1980

Attached is a copy of a communication which furnishes information concerning a current investigation. Exigent circumstances preclude a request for authorization in advance to utilize an electronic device to monitor and/or record private conversations with the consent of a party.

Under the provisions of Part II (a) of the Attorney General's Memorandum of October 16, 1972, to the Heads of Executive Departments and Agencies entitled, "Monitoring Private Conversations with the Consent of a Party," emergency monitoring was instituted during the authorization of an appropriate official of the FBI.

Monitoring of this conversation was authorized in the best interest of law enforcement in that it was expected to provide corroborative evidence and to protect the individual utilizing the equipment.

Further monitoring is expected in this matter and it is requested that your office approve the use of this equipment for a period of 30 days beginning the date on which you grant approval.

Enclosure

APPROVED:

Director \_\_\_\_\_  
Exec. AD-Inv. \_\_\_\_\_  
Exec. AD-Adm. \_\_\_\_\_  
Exec. AD-LES \_\_\_\_\_

Adm. Serv. \_\_\_\_\_  
Crim. Inv. \_\_\_\_\_  
Ident. \_\_\_\_\_  
Intell. \_\_\_\_\_  
Laboratory \_\_\_\_\_

Legal Coun. \_\_\_\_\_  
Plan. & Insp. \_\_\_\_\_  
Rec. Mgnt. \_\_\_\_\_  
Tech. Servs. \_\_\_\_\_  
Training \_\_\_\_\_  
Public Affs. Off. \_\_\_\_\_

Exec AD Inv. \_\_\_\_\_  
Exec AD Adm. \_\_\_\_\_  
Exec AD LES \_\_\_\_\_  
Asst. Dir.:  
Adm. Servs. \_\_\_\_\_  
Crim. Inv. \_\_\_\_\_  
Ident. \_\_\_\_\_  
Intell. \_\_\_\_\_  
Laboratory \_\_\_\_\_  
Legal Coun. \_\_\_\_\_  
Plan. & Insp. \_\_\_\_\_  
Rec. Mgnt. \_\_\_\_\_  
Tech. Servs. \_\_\_\_\_  
Training \_\_\_\_\_  
Public Affs. Off. \_\_\_\_\_  
Telephone Rm. \_\_\_\_\_  
Director's Sec'y \_\_\_\_\_

ENCLOSURE  
MAIL ROOM   
Squad report to [redacted]  
7/11/80 [redacted]

JUL 16 1980

b3  
b6  
b7C  
b7E

FBI/DOJ  
b6  
b7C

039

[redacted]

MESSAGE RELAY VIA TELETYPE

DATE 7/31/80	CLASSIFICATION <del>Confidential</del>	PRECEDENCE Priority
-----------------	---	------------------------

FM DIRECTOR FBI

TO Legat, Panama (VIA Mexico City)

b3  
b7E

[Large redacted area]

(SERVICE ALSO AVAILABLE TO GOVERNMENT AGENCIES NOT LISTED. )

CONTACT COMMUNICATIONS CENTER FOR ADDRESSING INFORMATION)

SUBJECT:

See attached

APPROVED BY [redacted]	ORIGINATOR [redacted]	ROOM 4052	TELE EXT. 4660
---------------------------	--------------------------	--------------	-------------------

b3  
b6  
b7C  
b7E

23 [redacted] [redacted] [redacted]

17 [redacted]

DO NOT FILE WITHOUT COMMUNICATIONS STAMP

USE OF FORM 0-73

1. Only incoming teletype messages which require transmission relay may be prepared for transmission using form 0-73. Use of form 0-73 is restricted to incoming teletype messages received within the last 3 days which require transmission relay; all other teletype messages must be prepared using form 0-93.
2. Additions such as notes and administrative data for a specific addressee are not allowed. If a note or administrative data is required for a particular addressee a separate 0-73 form must be prepared.
3. The message will be transmitted just as it appears. The person approving the message is solely responsible for assuring all necessary editing changes have been made.

PREPARATION OF FORM WHICH CONSISTS OF A PREPRINTED YELLOW.

1. Complete appropriate boxes: date, classification & precedence.
2. List addresses immediately following the "TO" or place a check mark in the appropriate boxes.
3. Type or PRINT the subject in the space provided.
4. Print or type originator's name, room number and telephone extension.
5. Indicate approval for transmission by initialing the "Approved By" box.

PREPARATION OF MESSAGE TO BE TRANSMITTED

1. Xerox 1 copy of incoming teletype message. A notation shall be made on the original incoming teletype "1 copy made for relay to SACS \_\_\_\_\_, (OR LEGATS) \_\_\_\_\_, (OR GOVERNMENT AGENCIES) \_\_\_\_\_."
2. Minor editing changes shall be made on the xerox as follows: using a lead pencil ONLY draw single line through first and last lines of the heading and connect these lines from top right to bottom left forming a "Z," figure. (DO NOT OBLITERATE THE HEADING.) Use horizontal lines to delete sentences or words. Printed changes of a word or two to the text of the message may be made; however, changes to the existing text involving more than a word or two necessitate the originator to initiate a new message using form 0-93.
3. Administrative data or notes may be typed immediately following the text and will be transmitted to all addressees.
4. When using the 0-73 form to disseminate information to field offices, Legal Attaches and other Government agencies simultaneously, the text, notes and administrative data must be identical for all addressees.

COMMUNICATIONS  
3 JUL 80 1428

G  
A  
P



DEPARTMENT OF JUSTICE  
FEDERAL BUREAU OF INVESTIGATION  
COMMUNICATION MESSAGE FORM

DECLASSIFICATION AUTHORITY DERIVED FROM:  
FBI AUTOMATIC DECLASSIFICATION GUIDE  
DATE 03-01-2023 BY: [REDACTED]

b6  
b7C

PAGE 1 OF 2

DATE  
7/8/80

CLASSIFICATION  
~~SECRET~~

PRECEDENCE  
PRIORITY

#STPP 45 413 416 48 46 418 417 428423 H0103 1910115

4STEP 082142Z JUL 80

FM DIRECTOR FBI

FEDERAL GOVERNMENT

TO

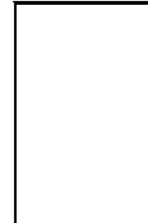
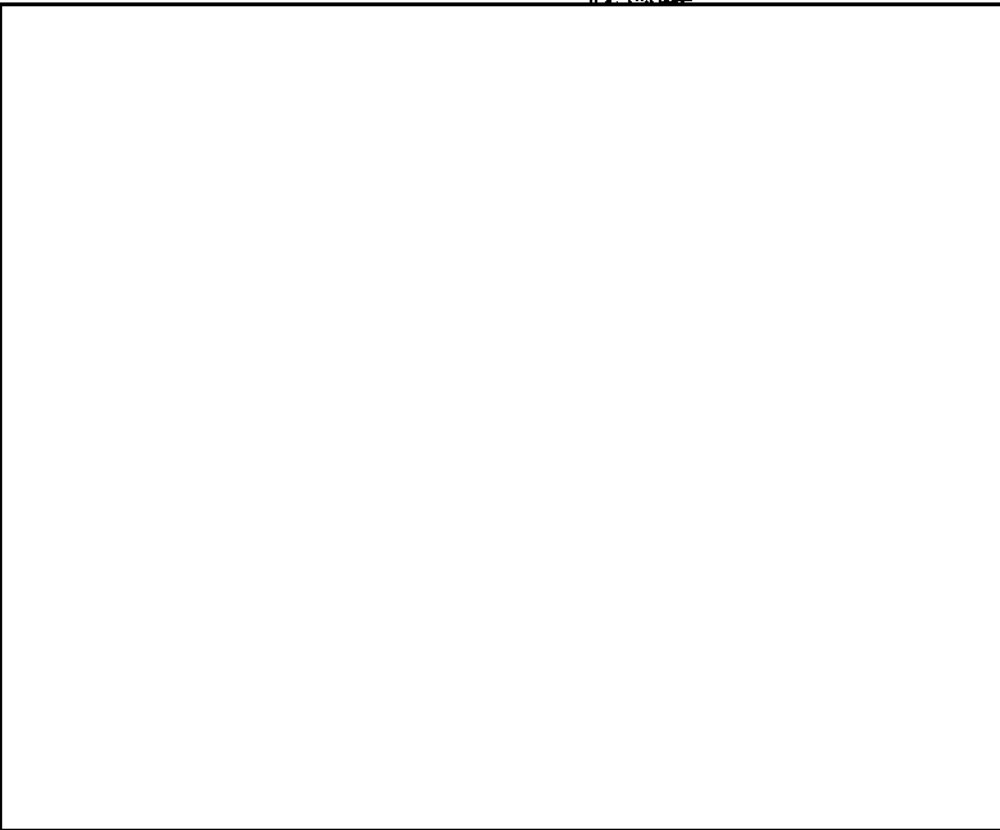

DO NOT FILE WITHOUT THIS INFO

b3  
b6  
b7C  
b7E

BT

~~SECRET~~

PLOT BY UNKNOWN NICARAGUANS TO ASSASSINATE FIDEL CASTRO:

DO NOT FILE WITHOUT THIS INFO

APPROVED BY	[REDACTED]	DRAFTED BY	[REDACTED]	DATE	ROOM	TELE EXT.
			EE3	7/8/80	4147/5	4605

b3  
b6  
b7C  
b7E

1 - [REDACTED]  
1 - [REDACTED]

BUREAU OF INVESTIGATION SEE NOTE PAGE 3  
COMMUNICATIONS CENTER

06AUG 7 20

ROUTE 102 ENVELOPE

JUL 9 1980

DEPARTMENT OF JUSTICE  
FEDERAL BUREAU OF INVESTIGATION  
COMMUNICATION MESSAGE FORM

PAGE 2

CONTINUATION SHEET

~~PAGEARTW02423 0103 S E C R E T~~

b3  
b7E

20 REFERENCE THIS BUREAU'S TELETYPE OF JULY 8, 1980,  
18 CAPTIONED AS ABOVE. {U}

16 THE FOLLOWING WAS INADVERTENTLY OMITTED FROM REFERENCED  
TELETYPE:

14 "WARNING NOTICE/SENSITIVE SOURCES AND METHODS. ~~NO~~  
~~FOREIGN DISSEMINATION.~~ NO DISSEMINATION SHOULD BE MADE WITHOUT  
PRIOR CONCURRENCE OF THIS BUREAU." ~~TS~~ (U)

12 INASMUCH AS OUR SOURCE IN THIS MATTER IS SENSITIVE, IT IS  
10 REQUESTED THAT THESE CAVEATS BE STRICTLY APPLIED. ~~TS~~ (U)

~~C AND E 5170, REASON (2) - DRD JULY 8, 2000~~

BT

8

6

4

2

DO NOT TYPE PAST THIS LINE

DO NOT TYPE MESSAGE BELOW THIS LINE



PAGE THREE 7/8/80 PLOT OF UNKNOWN NICARAGUANS TO ASSASSINATE  
FIDEL CASTRO

~~SECRET~~

NOTE:

Retel was disseminated 7/8/80, by CID without caveats  
as MM incoming did not mention sensitivity of source. Source  
is  ~~ISI~~ (U)

b3  
b7D  
b7E

TO  
A  
P

[redacted]

MESSAGE RELAY VIA TELETYPE

b6  
b7C

DATE 7/8/80	CLASSIFICATION <del>Secret</del>	PRECEDENCE Priority
----------------	-------------------------------------	------------------------

FM DIRECTOR FBI

TO

b3  
b7E

FEDERAL GOVERNMENT

(SERVICE ALSO AVAILABLE TO GOVERNMENT AGENCIES NOT LISTED.   
 CONTACT COMMUNICATIONS CENTER FOR ADDRESSING INFORMATION)   
 SUBJECT:

APPROVED BY [redacted]	ORIGINATOR [redacted]	ROOM 4052	TELE EXT. 4660
---------------------------	--------------------------	--------------	-------------------

b3  
b6  
b7C  
b7E

[redacted]

17142 [redacted]

[redacted]

DO NOT FILE WITHOUT COMMUNICATIONS STAMP

## USE OF FORM 0-73

1. Only incoming teletype messages which require transmission relay may be prepared for transmission using form 0-73. Use of form 0-73 is restricted to incoming teletype messages received within the last 3 days which require transmission relay; all other teletype messages must be prepared using form 0-93.
2. Additions such as notes and administrative data for a specific addressee are not allowed. If a note or administrative data is required for a particular addressee a separate 0-73 form must be prepared.
3. The message will be transmitted just as it appears. The person approving the message is solely responsible for assuring all necessary editing changes have been made.

### PREPARATION OF FORM WHICH CONSISTS OF A PREPRINTED YELLOW.

1. Complete appropriate boxes: date, classification & precedence.
2. List addresses immediately following the "TO" or place a check mark in the appropriate boxes.
3. Type or PRINT the subject in the space provided.
4. Print or type originator's name, room number and telephone extension.
5. Indicate approval for transmission by initialing the "Approved By" box.

COMMUNICATIONS SECTION  
8 JUL 80 15 42

### PREPARATION OF MESSAGE TO BE TRANSMITTED

1. Xerox 1 copy of incoming teletype message. A notation shall be made on the original incoming teletype "1 copy made for relay to SACS \_\_\_\_\_, (OR LEGATS) \_\_\_\_\_, (OR GOVERNMENT AGENCIES) \_\_\_\_\_."
2. Minor editing changes shall be made on the xerox as follows: using a lead pencil ONLY draw single line through the first and last lines of the heading and connect these lines from top right to bottom left forming a "Z," figure. (DO NOT OBLITERATE THE HEADING.) Use horizontal lines to delete sentences or words. Printed changes of a word or two to the text of the message may be made; however, changes to the existing text involving more than a word or two necessitate the originator to initiate a new message using form 0-93.
3. Administrative data or notes may be typed immediately following the text and will be transmitted to all addressees.
4. When using the 0-73 form to disseminate information to field offices, Legal Attaches and other Government agencies simultaneously, the text, notes and administrative data must be identical for all addressees.

MM0014 1900130Z

PP HI

DE MM

P07 0130Z JUL 80

FM MIAMI (P)

TO DIRECTOR PRIORITY

BT

~~SECRET~~

PLOT BY UNKNOWN NICARAGUANS TO ASSASSINATE FIDEL CASTRO,

RECEIVED  
TELETYPE UNIT

8 JUL 80 01 48z

FEDERAL BUREAU  
OF INVESTIGATION  
COMMUNICATIONS SECTION

Exec. AD-Inv.	
Exec. AD-Adm.	
Exec. AD-LES	
Asst. Dir.:	
Adm. Serv.	
Crim. Inv.	
Ident.	
Intell.	
Laboratory	
Legal Coun.	
Plan. & Insp.	
Rec. Mgnt.	
Tech. Servs.	
Training	
Public Affs. Off.	
Telephone Rm.	
Director's Sec'y	

b3  
b6  
b7C  
b7E

*In teletype dated 7/7/80*

*Miami FBI advised as follows:*

ON JULY 3, 1980, AN OPERATIONAL ASSET WHO HAS PROVIDED

RELIABLE INFORMATION IN THE PAST ADVISED AS FOLLOWS: ASSET

ADVISED

b3  
b6  
b7C  
b7E

[Large redacted area]

b3  
b7D

(S)

*0370  
7/7/80*

*6/14*

b3  
b6  
b7C  
b7E

PAGE TWO

[REDACTED]

~~SECRET~~

ASSET STATED THAT

[REDACTED]

[REDACTED]

[REDACTED]

(S)

U 4035

8

~~C AND E BY 1357, REASON 2, DRD JULY 7, 2000.~~

~~ADMINISTRATIVE OPERATIONAL ASSET IS~~

[REDACTED]

~~BEING REQUESTED TO FURNISH THE ABOVE TO~~

[REDACTED]

~~FOR THEIR~~

~~INFORMATION.~~

~~IT SHOULD BE NOTED THAT ASSET OBTAINED THE ABOVE INFORMATION~~

[REDACTED]

BT

b3  
b7D  
b7E

b3  
b7D  
b7E

b3  
b6  
b7C  
b7D

UNITED STATES GOVERNMENT

UNITED STATES DEPARTMENT OF JUSTICE  
FEDERAL BUREAU OF INVESTIGATION

# Memorandum

- Exec AD Inv. \_\_\_\_\_
- Exec AD Adm. \_\_\_\_\_
- Exec AD LES \_\_\_\_\_
- Asst. Dir.:
- Adm. Servs. \_\_\_\_\_
- Crim. Inv. \_\_\_\_\_
- Ident. \_\_\_\_\_
- Intell. \_\_\_\_\_
- Laboratory \_\_\_\_\_
- Legal Coun. \_\_\_\_\_
- Plan. & Insp. \_\_\_\_\_
- Rec. Mgnt. \_\_\_\_\_
- Tech. Servs. \_\_\_\_\_
- Training \_\_\_\_\_
- Public Affs. Off. \_\_\_\_\_
- Telephone Rm. \_\_\_\_\_
- Director's Sec'y \_\_\_\_\_

TO : [Redacted]

DATE: 8/26/80

FROM : [Redacted]

- b3 \_\_\_\_\_
- b6 \_\_\_\_\_
- b7C \_\_\_\_\_
- b7E \_\_\_\_\_

SUBJECT: PLOT TO ASSASSINATE CUBAN  
PRESIDENT FIDEL CASTRO  
DURING PLANNED VISIT TO  
NICARAGUA JULY, 1980

[Redacted]

Enclosed for filing is an approval request for consensual monitoring.

*in*

SEAL ENCL  
ENCLOSURE ATTACHED

[Redacted]

17 SEP 11 1980

[Redacted]

- b3
- b6
- b7C
- b7E

Enclosure

[Redacted]  
53 SEP 22 1980

10.28

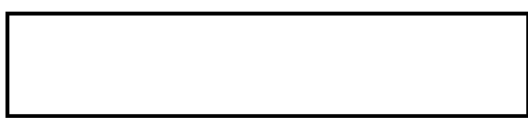

b3  
b7E

~~SECRET~~

----- Working Copy -----

Precedence: ROUTINE

Date: 07/27/1998

To: Miami

From: Miami

Contact: Det. [redacted] Ext. [redacted]

Approved By: [redacted]

b3  
b6  
b7C  
b7E

Drafted By: [redacted]

Case ID #: (U) ~~(S)~~ [redacted] (Pending)

Title: ~~(S)~~ UNSUBS; [redacted] ET AL;  
(U) [redacted]  
(U) [redacted] OO:MM

Synopsis: ~~(S)~~ Information received from Det. [redacted] Miami Police Department, Special Investigation Section/ Bomb Squad concerning a plot to assassinate Cuban President Fidel Castro.

b6  
b7C

(U) ~~(S)~~ Derived From: G-1  
Declassify On: X1

Details: (U) ~~(S)~~ On July 27, 1998, Det. [redacted] advised me of a conversation he had with a CONFIDENTIAL SOURCE. The SOURCE explained to him that [redacted]

b6  
b7C  
b7D

[redacted]

(U) ~~(S)~~ According to the SOURCE, [redacted]

b6  
b7C  
b7D

(U) ~~(S)~~ The SOURCE also discussed [redacted]  
[redacted]

Lead (s):

set lead 1: (Adm)

Miami

Case ID : [redacted]

~~SECRET~~

b3  
b7E



b6  
b7C

Precedence: ROUTINE

Date: 07/29/1998

To: Tampa  
Miami

Attn: [redacted]

From: Miami

[redacted]  
Contact: Det. [redacted] Ext. [redacted]

Approved By: [redacted]

Drafted By: [redacted]

Case ID #: (U) (S) [redacted] (Pending)

b3  
b6  
b7C  
b7E

Title: (S) UNSUB: [redacted] ET AL;  
(U) [redacted] OO:MM

Synopsis: Information received from Det. [redacted] Miami Police Department, Special Investigation Section/ Bomb Squad concerning a plot to assassinate Cuban President Fidel Castro and a failed mission by [redacted]

b6  
b7C

Details: On July 29, 1998, Det. [redacted] advised me of a conversation he had with a CONFIDENTIAL SOURCE. The source provided the following information:

b6  
b7C

[Large redacted area]

b6  
b7C  
b7D

Case ID : [redacted]

[redacted]

b3  
b7E

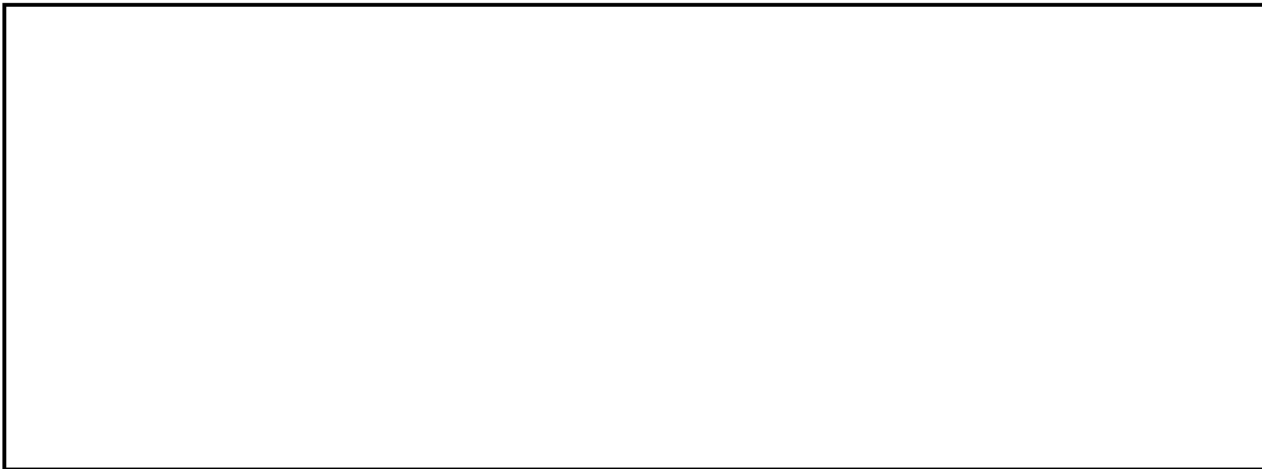

b6  
b7C  
b7D

LEAD (s):

Set Lead 1: (Adm)

ALL RECEIVING OFFICES

(U) ~~(S)~~ Miami

For informational purpose only

Set Lead 2:

TAMPA

AT TAMPA

(U)

~~(S)~~ Interview



phone

b6  
b7C

regarding described plot to assassinate Cuban  
President Fidel Castro.

FEDERAL BUREAU OF INVESTIGATION  
FOI/PA  
DELETED PAGE INFORMATION SHEET  
FOI/PA# 1362425-000

Total Deleted Page(s) = 2  
Page 1 ~ b3; b6; b7C; b7E;  
Page 2 ~ b3; b6; b7C; b7D; b7E;

XXXXXXXXXXXXXXXXXXXXXXXXXXXX  
X Deleted Page(s) X  
X No Duplication Fee X  
X For this Page X  
XXXXXXXXXXXXXXXXXXXXXXXXXXXX

FEDERAL BUREAU OF INVESTIGATION  
FOI/PA  
DELETED PAGE INFORMATION SHEET  
FOI/PA# 1362425-000

Total Deleted Page(s) = 3  
Page 1 ~ b3; b7D; b7E;  
Page 7 ~ b3; b7D; b7E;  
Page 8 ~ b3; b7D; b7E;

XXXXXXXXXXXXXXXXXXXXXXXXXXXX  
X Deleted Page(s) X  
X No Duplication Fee X  
X For this Page X  
XXXXXXXXXXXXXXXXXXXXXXXXXXXX

FEDERAL BUREAU OF INVESTIGATION  
FOI/PA  
DELETED PAGE INFORMATION SHEET  
FOI/PA# 1362425-000

Total Deleted Page(s) = 3  
Page 1 ~ b3; b6; b7C; b7E;  
Page 3 ~ b3; b7E;  
Page 4 ~ b3; b7E;

XXXXXXXXXXXXXXXXXXXXXXXXXXXX  
X Deleted Page(s) X  
X No Duplication Fee X  
X For this Page X  
XXXXXXXXXXXXXXXXXXXXXXXXXXXX

(Mount Clipping in Space Below)

# DEA investigará posible narcotráfico vía Cuba

Washington —(AFP)— El jefe de la Dirección contra las Drogas (DEA) de Estados Unidos, Thomas Constantine, prometió el jueves ante un panel del Congreso que investigará a fondo las alegaciones de tráfico de narcóticos a través de Cuba, después que varios congresistas denunciaron una presunta responsabilidad del régimen del gobernante Fidel Castro.

En un testimonio ante la Subcomisión de Asuntos Hemisféricos de la Cámara de Representantes, Constantine dijo que "frecuentemente" embarcaciones con drogas procedentes de América del Sur buscan refugio en aguas cubanas "donde no pueden ser perseguidos", y "ni los guardacostas ni la marina cubanas toman ninguna acción para impedir que los traficantes usen sus aguas".

Declaró igualmente que vuelos de drogas "usan el espacio aéreo cubano para cubrir sus rutas", y la oficina de la DEA en Nassau, Bahamas, informó que "en los últimos dos años 28 vuelos identificados positivamente con cargas de cocaína cruzaron el espacio aéreo cubano en ruta hacia sus puntos de entrega".

"Tres de esos vuelos ocurrieron este año" puntualizó Constantine.

Agregó que "no hay evidencias de que el gobierno de Cuba sea cómplice en estas empresas de contrabando, ni tenemos información de hasta qué punto el gobierno cubano actúa, si es que lo hace, para detectar vuelos de drogas y negarles acceso a su espacio aéreo".

El congresista demócrata Robert Menéndez sugirió que el tráfico de drogas no podría hacerse sin la complicidad del gobierno de La Habana.

"Este es un régimen que tiene control sobre su territorio, como lo ha demostrado una y otra vez. Nadie penetra el espacio aéreo ni las aguas territoriales de Cuba sin que Fidel y Raúl Castro lo sepan", afirmó.

Constantine coincidió con Menéndez y prometió "perseguir a estos grupos tan activamente como sea posible".

"Yo creo que su análisis del asunto y del problema son correctos", dijo el jefe de la DEA.

La presunta responsabilidad del gobierno cubano en el narcotráfico fue denunciada también por Dan Burton, presidente de la subcomisión y varios otros miembros del panel, entre ellos los cubano-americanos Ileana Ross y Lincoln Diaz-Balart.

(Indicate page, name of newspaper, city and state.)

Date: 6/08/96  
Edition: EL Nuevo Herald

Title: DEA Investiga posible Narcotráfico via Cuba

Character:  
or  
Classification:  
Submitting Office: Miami

Indexing:

b6  
b7C

b6  
b7C

b6  
b7C

92BMM-52044-Sub N

92BMM-52044-Sub N-956

SEARCHED	INDEXED
SERIALIZED	FILED
JUN 10 1996	
FBI - MIAMI	
92B-MMM-52044	

(Mount Clipping in Space Below)

(Indicate page, name of newspaper, city and state.)

SUN SENTINEL

Date: JUNE 16, 1996  
Edition: PAGE: 13A AND 14A

Title: DIAZ-BALART SEEKS  
INQUIRY OF RELEASE

Character:  
or  
Classification:  
Submitting Office:

MIAMI DIVISION

Indexing:

# Diaz-Balart seeks inquiry of release

By COLIN MCMAHON  
Chicago Tribune

BOGOTA, Colombia — Since the dramatic release last week of kidnapping victim Juan Carlos Gaviria, questions about the high-profile, politically sensitive case have stretched from Bogota to Havana to Washington.

U.S. Rep. Lincoln Diaz-Balart, a Miami Republican, has asked the House Foreign Affairs Committee to investigate Gaviria's release. At issue is the involvement of Cuban President Fidel Castro and Cesar Gaviria, the victim's brother and current chief of the Organization of American States.

What are the terms of the deal be-

tween the secretary general of the OAS and the Castro regime?" Diaz-Balart asked. "Can [Cesar] Gaviria act impartially in the OAS when he has entered into deal with the kidnapers and the Castro government for the liberation of his brother?"

Juan Carlos Gaviria, 42, an architect, was released on Wednesday after more than two months in captivity. Several of his captors, escorted by representatives of the Castro government, were then allowed to board a plane to Havana.

Some, including the respected Bogota newspaper *El Tiempo*, praised the deal on Friday as the only way to save Gaviria's life. But others condemned

what they called the undermining of justice.

"This will promote more kidnappings in Colombia," said Francisco Vargas, whose group represents victims of attacks by Colombia's guerrillas.

Vargas said officials estimate that 1,400 Colombians currently are held captive, many by leftist rebels who use kidnapping as a source of income. A special anti-abduction police squad has been ineffective, critics contend, and paying ransom remains the principal path to freedom.

Gaviria was kidnapped by a group

PLEASE SEE RELEASE /14A

D-7 92B-MM-52044-Sub N

D-7

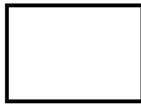

92B-MM-52044-Sub N 1002

b6  
b7C

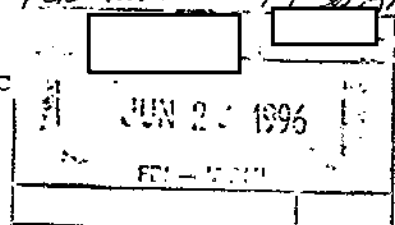

RELEASE

FROM PAGE 13A

## U.S. representative asks for inquiry into man's release

calling itself Dignity for Colombia. It made several political demands and threats, the most immediate that Gaviria would be executed if Colombia's congress exonerated President Ernesto Samper of corruption charges. It did so, overwhelmingly, on Wednesday night.

Dignity for Colombia turned out to be little more than a front slogan for Jega, a guerrilla group responsible for a series of kidnappings and, Vargas said, several assassinations.

Cuban officials said they got involved for humanitarian reasons. But in a Colombian radio interview on Friday, Castro acknowledged that ideological common ground with the leader of the kidnapping group helped in reaching a deal.

According to news reports and sources familiar with the Gaviria case, police knew the identity of the kidnappers for some time but only were able to capture members of the group Tuesday night.

The kidnappers, who were directed from a Colombian prison by a former rebel known as Bochico, were given a choice: Give up their hostage or go to prison. Bochico's first counteroffer included his own release, but authorities said no. He then negotiated safe passage for the group's leadership, and the deal was sealed with a personal letter from Castro.

By Wednesday afternoon, Gaviria was a free man.

The questions now focus on Cesar Gaviria, who was Colombia's president from 1990-1994.

Last week at the OAS annual meeting in Panama City, members approved a stinging rebuke of the United States over the Helms-Burton Act, which aims to punish some foreign companies doing business in Cuba. Diaz-Balart and others now say they wonder whether there may have been a connection between that action and the kidnapping case.

"I can state emphatically that at no time did I, as secretary general of the OAS, act in any way that could be construed as using my office to secure the release of my brother," Gaviria wrote to Diaz-Balart on Thursday. "The action taken last week . . . regarding the Helms-Burton law was solely the decision of the member states."

Still, Diaz-Balart remained critical on Friday, accusing Cesar Gaviria of having "conveyed legitimacy to terrorism."



FEDERAL BUREAU OF INVESTIGATION  
FOI/PA  
DELETED PAGE INFORMATION SHEET  
FOI/PA# 1362425-000

Total Deleted Page(s) = 2  
Page 1 ~ b3; b6; b7C; b7E;  
Page 2 ~ b3; b7E;

XXXXXXXXXXXXXXXXXXXXXXXXXXXX  
X Deleted Page(s) X  
X No Duplication Fee X  
X For this Page X  
XXXXXXXXXXXXXXXXXXXXXXXXXXXX

FEDERAL BUREAU OF INVESTIGATION  
FOI/PA  
DELETED PAGE INFORMATION SHEET  
FOI/PA# 1362425-000

Total Deleted Page(s) = 2  
Page 1 ~ b3; b6; b7C; b7E;  
Page 2 ~ b3; b7E;

XXXXXXXXXXXXXXXXXXXXXXXXXXXX  
X Deleted Page(s) X  
X No Duplication Fee X  
X For this Page X  
XXXXXXXXXXXXXXXXXXXXXXXXXXXX

FEDERAL BUREAU OF INVESTIGATION  
FOI/PA  
DELETED PAGE INFORMATION SHEET  
FOI/PA# 1362425-000

Total Deleted Page(s) = 3  
Page 10 ~ Duplicate;  
Page 11 ~ Duplicate;  
Page 12 ~ Duplicate;

XXXXXXXXXXXXXXXXXXXXXXXXXXXX  
X Deleted Page(s) X  
X No Duplication Fee X  
X For this Page X  
XXXXXXXXXXXXXXXXXXXXXXXXXXXX



CODE

TELETYPE

NITEL

b6  
b7C

OCTOBER 7, 1974

1 - [redacted]

**EX-103**

TO SAC, SAN JUAN

**REC-71**

FROM DIRECTOR, FBI

*Handwritten notes:*  
07  
210  
2/19/75  
2/10/75

UNKNOWN SUBJECTS (3), ALSO KNOWN AS; POSSIBLE  
ASSASSINATION ATTEMPT ON PREMIER FIDEL CASTRO OF CUBA,  
OCTOBER-NOVEMBER, 1974, [redacted]

b3  
b6  
b7C  
b7E

RESJTEL OCTOBER 4, 1974.

DEPARTMENT OF STATE, OCTOBER 7, 1974, ADVISED IT HAS  
NO INFORMATION CONCERNING ANY ISLAND IN THE LESSER  
ANTILLES WHICH IS TO BECOME INDEPENDENT IN THE IMMEDIATE  
FUTURE.

SAN JUAN BE CERTAIN TO KEEP MIAMI AND THE BUREAU  
APPRISED OF ALL PERTINENT DEVELOPMENTS.

b6  
b7C

MIAMI ADVISED BY MAIL.

1 - Miami (BY MAIL)

FEDERAL BUREAU OF INVESTIGATION  
COMMUNICATIONS SECTION

b6  
b7C

OCT 07 1974  
10:36  
**TELETYPE**

- Asso. Dir. \_\_\_\_\_
- Dep. AD Adm. \_\_\_\_\_
- Dep. AD Inv. \_\_\_\_\_
- Asst. Dir.:
- Admin. \_\_\_\_\_
- Comp. Syst. \_\_\_\_\_
- Ext. Affairs \_\_\_\_\_
- Files & Com. \_\_\_\_\_
- Gen. Inv. \_\_\_\_\_
- Ident. \_\_\_\_\_
- Inspection \_\_\_\_\_
- Intell. \_\_\_\_\_
- Laboratory \_\_\_\_\_
- Plan. & Eval. \_\_\_\_\_
- Spec. Inv. \_\_\_\_\_
- Training \_\_\_\_\_
- Legal Coun. \_\_\_\_\_
- Telephone Rm. \_\_\_\_\_
- Director Sec'y \_\_\_\_\_

[redacted]  
(4)

SEE NOTE PAGE TWO

b6  
b7C

MAIL ROOM

TELETYPE UNIT

Teletype to San Juan

Re: Unknown Subjects (3), Also Known As;  
Possible Assassination Attempt on  
Premier Fidel Castro of Cuba,  
October-November, 1974

NOTE:

~~SECRET~~

Classified "~~Secret~~" since it contains highly sensitive information received from [redacted]

[redacted] furnished highly sensitive information indicating that [redacted]

b7D

[redacted] The information has been disseminated to interested U. S. Government agencies.

San Juan requested we determine through logical sources whether any island in the Lesser Antilles is to become independent in the immediate future and whether there is any information to indicate that Castro will be visiting that island.

[redacted] State Department, furnished the information originating with State set forth above to SA [redacted] on 10/7/74.

b6  
b7C

~~Classified by 2111, XGDS2, Date of Declassification Indefinite.~~

~~SECRET~~

# MESSAGE RELAY

Date 10/4/74

Transmit in CODE via teletype the attached PRIORITY message.  
(plaintext or code) (precedence)

\*\*\*\*\*  
\* \* \* \* \*  
\* \* \* \* \*

FROM: Director, FBI [redacted]

EX-103

REC-71

**FIELD DISSEMINATION**

TO:

[redacted]

SACS: MIAMI  
SAN JUAN

b3  
b7E

[redacted]

Assoc. Dir. \_\_\_\_\_ Classification: (Classify if to other than Bureau Office)

~~SECRET~~

Dep. AD Adm. \_\_\_\_\_

Dep. AD Inv. \_\_\_\_\_

SUBJECT:

**SEE NEXT PAGE**

Asst. Dir.:

Admin. \_\_\_\_\_

Comp. Syst. \_\_\_\_\_

Ext. Affairs \_\_\_\_\_

Files & Com. \_\_\_\_\_

Gen. Inv. \_\_\_\_\_

Ident. \_\_\_\_\_

Inspection \_\_\_\_\_

Intell. \_\_\_\_\_

Laboratory \_\_\_\_\_

Plan. & Eval. \_\_\_\_\_

Spec. Inv. \_\_\_\_\_

Training \_\_\_\_\_

Legal Coun. \_\_\_\_\_

Telephone Rm. \_\_\_\_\_

Director Sec'y \_\_\_\_\_

Foreign Liaison Unit

Route through for review

Cleared telephonically

with \_\_\_\_\_

FEDERAL BUREAU OF INVESTIGATION

COMMUNICATIONS SECTION

(Text of message begins on next page.)

[redacted]

TELETYPE

[redacted]

[redacted]

749 940

MAIL ROOM

TELETYPE UNIT

b6  
b7c

b6  
b7C  
~~9 & 10 COPY  
DO NOT FILE~~

NR002 SJ CODE

8:49 PM URGENT OCTOBER 4, 1974 SAA 3P

TO DIRECTOR

FROM SAN JUAN [REDACTED]

b3  
b7E

ATTENTION: INTELLIGENCE DIVISION

~~SECRET~~

UNKNOWN SUBJECTS (3), ALSO KNOWN AS; POSSIBLE ASSASSINATION  
ATTEMPT ON PREMIER FIDEL CASTRO OF CUBA, OCTOBER-NOVEMBER, 1974,

b3  
b7E

[REDACTED]

~~THE FOLLOWING INFORMATION IS CLASSIFIED SECRET.~~

ON OCTOBER 4, 1974, [REDACTED]

[REDACTED]

ADVISED THAT

[REDACTED]

b6  
b7C  
b7D

END PAGE ONE

PAGE TWO

[REDACTED]

~~SECRET~~

b3  
b7E

[REDACTED]

b6  
b7C  
b7D

ADMINISTRATIVE:

THE BUREAU IS REQUESTED TO FURNISH THE ABOVE INFORMATION TO

[REDACTED] THE U. S. DEPARTMENT OF STATE [REDACTED]

b3  
b7E

[REDACTED] IN ADDITION THE  
U. S. STATE DEPARTMENT MAY WISH TO FURNISH THE ABOVE INFORMATION  
TO THE APPROPRIATE AUTHORITIES.

REQUEST OF THE BUREAU. THE BUREAU IS REQUESTED TO ASCERTAIN  
THROUGH LOGICAL SOURCES WHETHER ANY ISLAND IN THE LESSER ANTILLES  
IS TO BECOME INDEPENDENT IN THE IMMEDIATE FUTURE AND WHETHER  
THERE IS ANY INFORMATION TO INDICATE THAT PREMIER CASTRO WILL BE  
END PAGE TWO

THIS INFORMATION IS BEING FURNISHED TO THE DEPARTMENT OF STATE FOR  
ANY ACTION IT DEEMS APPROPRIATE.

FOR SAC, MIAMI:

MIAMI CONTACT LOGICAL SOURCES AND FURNISH ANY PERTINENT INFORMATION  
DEVELOPED CONCERNING THE ABOVE MATTER

CLASSIFIED BY 422, XGDS2, INDEFINITE.



PAGE THREE

~~SECRET~~

b3  
b7E

VISITING THAT ISLAND.

SAN JUAN ATTEMPTING TO DETERMINE THE IDENTITY OF ANY ISLANDS  
IN THE CARIBBEAN ANTICIPATING INDEPENDENCE.

SAN JUAN INDICES INDICATE [REDACTED]

b6  
b7C

SAN JUAN WILL MAINTAIN CONTACT WITH [REDACTED] FOR ADDITIONAL  
DETAILS AND INVESTIGATION CONTINUING. SUCOP.

b6  
b7C  
b7D

~~CLASSIFIED BY 3713, XGDS 2, INDEFINITE.~~

END.

Intelligence Division

INFORMATIVE NOTE

Date 10/4/74

On 10/4/74, [redacted] advised of highly sensitive information from a reliable source which indicated

b6  
b7C  
b7D

[redacted]

This information has been furnished by teletype to the Department of State for any action it deems appropriate [redacted]

[redacted] Copies have also been furnished to the Assistant Attorney General, Criminal Division (Internal Security/General Crimes Sections).

b3  
b7E

The Miami Office has been furnished information in the attached teletype and instructed to contact logical sources and furnish any pertinent information developed regarding the above matter.

[redacted] [redacted] [redacted] [redacted]

b6  
b7C

UNITED STATES GOVERNMENT

# Memorandum

TO : DIRECTOR, FBI

DATE: 2/3/75

FROM : *WJ/gjs*  
SAC, MIAMI [redacted] (RUC) [redacted]

b3  
b6  
b7C  
b7E

SUBJECT: [redacted]  
UNSUBS (3) aka;  
POSSIBLE ASSASSINATION ATTEMPT  
ON PREMIER FIDEL CASTRO,  
October - November, 1974 *victim*  
[redacted]  
(OO: SJ)

5  
2

Re Bureau teletype dated 10/4/74 and Bureau teletype to San Juan dated 10/7/74.

There is always a great deal of loose talk in Miami concerning the assassination of FIDEL CASTRO and every day in frequent gatherings some irate Cuban states that he is going to kill FIDEL CASTRO. However, no specific plans to kill FIDEL CASTRO have come to the attention of Miami informants:

[redacted] contacted by SA [redacted]

[redacted] contacted by SA [redacted]

b6  
b7C  
b7D

[redacted] contacted by SA [redacted]

Inasmuch as logical Miami informants have failed to obtain any information indicating plans to kill FIDEL CASTRO, no additional investigation by the Miami Division is indicated.

[redacted] (2) Bureau (RM)  
1 - Miami 1 - San Juan (RM)  
[redacted]  
(4)

EX-101

REG-741

[redacted]

FEB 7 1975

b3  
b6  
b7C  
b7E

[redacted]



356  
FF

Buy U.S. Savings Bonds Regularly on the Payroll Savings Plan

UNITED STATES GOVERNMENT

# Memorandum

TO : DIRECTOR, FBI

DATE: 2-19-75

FROM : SAC, SAN JUAN [redacted] (C)

SUBJECT: UNSUBS (3); AKA POSSIBLE  
ASSASSINATION ATTEMPT ON  
PREMIER FIDEL CASTRO OF CUBA,  
OCTOBER-NOVEMBER, 1974

[redacted] 2

b3  
b6  
b7C  
b7E

[redacted] OO: SAN JUAN

Re San Juan teletype to the Bureau, 10-4-74,  
Bureau teletype to San Juan, 10-7-74, and Miami letter to  
the Bureau, 2-3-75.

For information of the Bureau, continued contact  
has been maintained with [redacted]

[redacted] advised

b6  
b7C  
b7D

On the dates indicated, the following sources familiar  
with Cuban activities in Puerto Rico were contacted and could  
furnish no information relating to this matter:

<u>Source</u>	<u>Date Contacted</u>	<u>Contacting Agent</u>
[redacted]	1-22-75 1-28-75 and 2-12-75 1-20-75 and 2-3-75	[redacted]

b3  
b6  
b7C  
b7D  
b7E

REC 44

[redacted]



2 - Bureau  
1 - San Juan  
[redacted] 1975

EX-101

FEB 24 1975

Buy U.S. Savings Bonds Regularly on the Payroll Savings Plan



b3  
b7E

Source

Date Contacted

Contacting Agent



1-8-75 and  
1-24-75  
1-8-75 and  
1-24-75  
2-4-75



b6  
b7C  
b7D

Inasmuch as  could furnish no additional information relating to this matter, and since all logical San Juan and Miami informants have failed to obtain any information indicating plans to kill FIDEL CASTRO, no additional investigation by the San Juan Office is contemplated and this case is being closed.

b6  
b7C  
b7D

(E) VISIT OF CUBAN PRESIDENT OSVALDO DORTICOS OR PRIME MINISTER FIDEL CASTRO TO CANADA IN JULY, 1967 -- [redacted]

[redacted] has advised that [redacted]  
[redacted]

b7D

[redacted] be alert to possible changes which may be announced in the press or may become available through other sources.

[redacted]

b7D

[redacted] Since anti-Castro Cuban exiles in this country in the past have travelled to Canada to attack Cuban establishments there, we can expect that they will plan various militant anti-Castro activities to be carried out in connection with this visit.

Each office alert logical sources and informants and advise the Bureau of any pertinent information received by the most expeditious means warranted [redacted] Submit data under caption of "Visit of Cuban President Osvaldo Dorticos or Prime Minister Fidel Castro to Canada in July, 1967, [redacted]"

b3  
b7D  
b7E

It is noted that when President Dorticos came to the U. S. in 1962 to attend a United Nations session he was accompanied by an individual who was subsequently arrested in this country for conspiracy to commit sabotage in New York City. We can expect that such individuals will accompany Dorticos or Castro on the proposed visit. In addition, [redacted]

b3  
b7E

[redacted] Keep Bureau currently advised of any pertinent information received along these lines under an appropriate caption.

2-28-67  
SAC LETTER 67-14

[redacted]

SEARCHED [redacted] INDEXED [redacted]  
SERIALIZED [redacted] FILED [redacted]  
MAR 3 1967  
FBI - SAN ANTONIO

b3  
b6  
b7C  
b7E

① JA

[redacted]

MEMO TO ALL AGENTS  
NO. 74

San Antonio, Texas  
3/20/67

RE: VISIT OF CUBAN PRESIDENT  
OSVALDO DORTICOS OR  
PRIME MINISTER FIDEL CASTRO  
TO CANADA IN JULY, 1967

As reference indicates. [redacted]

[redacted]

b7D

All Agents are requested to alert logical sources  
and informants so that the Bureau may be advised of any  
pertinent information received.

[redacted]

b6  
b7C

1-SAC  
1-ASAC  
1-Supervisor  
1-Each Agent (52)

1-[redacted]

1-66-125

[redacted]

(57)

[redacted]

b3  
b6  
b7C  
b7E

Searched [redacted]  
Serialized [redacted]  
Indexed [redacted]  
Filed [redacted]

b3  
b7E

[redacted]

DIRECTOR, FBI

4/20/67

SAC, SAN ANTONIO [redacted] (RUC)

b3  
b7E

VISIT OF CUBAN PRESIDENT  
OSVALDO DORTICOS or  
PRIME MINISTER FIDEL CASTRO  
TO CANADA IN JULY, 1967

Re SAC letter 67-14, dated 2/28/67.

Informants and sources of the San Antonio Division  
have been alerted to the contents of the referenced communication.

If any positive information comes to the attention  
of the San Antonio Division, the Bureau will be immediately  
advised of all pertinent details.

*stripped  
& consolidated  
5-19-70*

b3  
b6  
b7C  
b7E

2 - Bureau  
1 - San Antonio

[redacted]

(3)

[redacted]

[redacted]

[redacted]



FEDERAL BUREAU OF INVESTIGATION  
FOI/PA  
DELETED PAGE INFORMATION SHEET  
FOI/PA# 1362425-000

Total Deleted Page(s) = 2  
Page 3 ~ b3; b6; b7C; b7E;  
Page 4 ~ b3; b7E;

XXXXXXXXXXXXXXXXXXXXXXXXXXXX  
X Deleted Page(s) X  
X No Duplication Fee X  
X For this Page X  
XXXXXXXXXXXXXXXXXXXXXXXXXXXX

9/8/67

**Airtel**

**To: SAC, New York**

**From: Director, FBI**

**ALLEGED PLAN OF CUBAN EXILES  
TO KIDNAP FIDEL CASTRO**

[Redacted]

[Redacted]

b3  
b7E

*unw ref*

**Enclosed for each recipient is a copy** [Redacted]

[Redacted]

**New York contact established sources and informants**

[Redacted]

b3  
b6  
b7C  
b7E

**Furnish results in form suitable for dissemination.**

**Enclosure**

- 1 - Miami (Enclosure)
- 1 - San Juan (Enclosure)
- 1 - WFO (Enclosure)
- 1 - Santo Domingo (Enclosure)

[Redacted]

[Redacted]

[Redacted]

[Redacted]

[Redacted]

[Redacted]

b3  
b6  
b7C  
b7E

[Redacted]

SEARCHED

INDEXED

SERIALIZED

FILED

SEP 25 1964

[Redacted]

b3  
b6  
b7C  
b7E

3-04 PM [REDACTED]

NR -----2----- 145 PM URGENT 9-21-67 [REDACTED]

TO DIRECTOR AND NEW YORK

NEW YORK VIA WA (ENCODED)

FROM LEGAT SANTO DOMINGO 3P

ALLEGED PLAN OF CUBAN EXILES TO KIDNAP FIDEL CASTRO, [REDACTED]

RE BUREAU AIRTEL SEPTEMBER EIGHT LAST CAPTIONED AS ABOVE, [REDACTED]

[REDACTED] BUTEL AUGUST TWENTYFOUR

LAST CAPTIONED [REDACTED] AND MYTEL AUGUST TWENTYONE

LAST, LIKEWISE CAPTIONED.

AS SET FORTH IN [REDACTED]

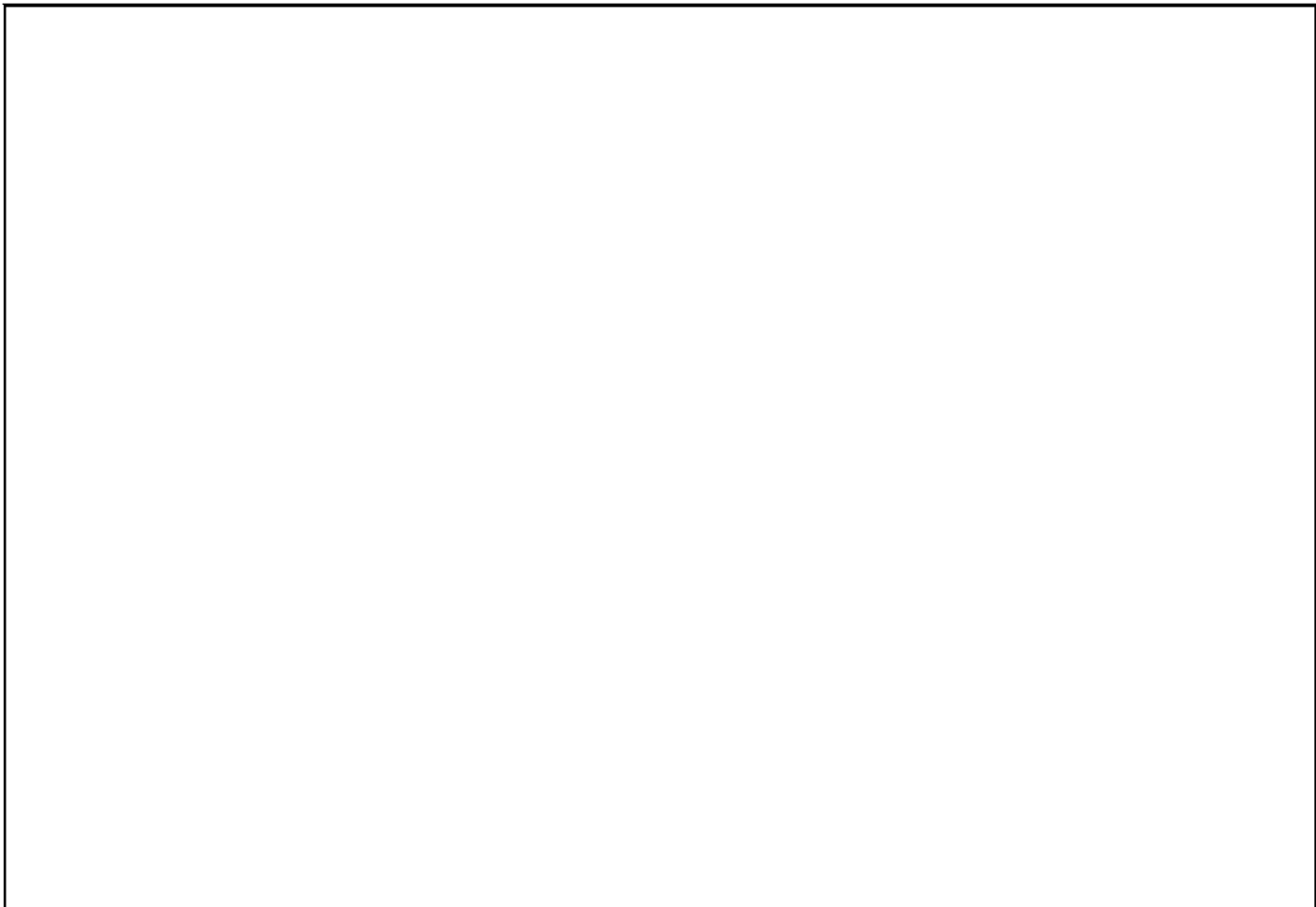

END PAGE ONE

b6  
b7C

b3  
b7E

b3  
b6  
b7C  
b7E

b3  
b6  
b7C  
b7D  
b7E

[REDACTED]

b3  
b6  
b7C  
b7E

DISCREET INVESTIGATION BY SANTO DOMINGO HAS DETERMINED NO INFORMATION WHICH WOULD INDICATE EITHER [REDACTED] OR [REDACTED]

b6  
b7C

[REDACTED] HAS TRAVELED TO THE DR DURING THE MONTH OF AUGUST, ONE NINE SIX SEVEN.

FOR THE INFORMATION OF THE BUREAU, LEGAT TELETYPE CAPTIONED

[REDACTED] ADVISED THIS INDIVIDUAL, A CUBAN EXILE FORMERLY ASSOCIATED WITH [REDACTED] RESIDING IN [REDACTED]

[REDACTED]

b3  
b6  
b7C  
b7E

[REDACTED] REFERENCED BUTEL SET FORTH INFORMATION CONCERNING ONE [REDACTED], BORN ON [REDACTED] ADDRESS [REDACTED]

[REDACTED] THIS INDIVIDUAL WAS ARRESTED BY U. S. CUSTOMS, MIAMI, AT [REDACTED]

b6  
b7C

5-9

PAGE THREE

ON JANUARY THREE LAST AND CHARGED WITH ILLEGAL EXPORTATION OF ARMS FROM THE U. S OF SEVENTYSIX INDIVIDUALS ARRESTED, CHARGES AGAINST ALL BUT SIX, INCLUDING [REDACTED] WERE SUBSEQUENTLY DROPPED. THE FEBRUARY TWENTYFIVE, ONE NINE SIX FIVE ISSUE OF "BOHEMIA", HAVANA, CUBA, MENTIONED [REDACTED]

b6  
b7C

[REDACTED]

IT IS THE OPINION OF LEGAT THAT [REDACTED] IS POSSIBLY IDENTICAL WITH (FNU) [REDACTED] DESCRIBED AS INVOLVED IN CUBAN EXILE PLOT TO KIDNAP CASTRO. IT IS NOTED THAT [REDACTED]

b3  
b6  
b7C  
b7E

[REDACTED] INVESTIGATION CONDUCTED THROUGH SOURCES OF SAN HAS DETERMINED NO INFORMATION CONCERNING ANY CUBAN NATIONAL NAMED [REDACTED] HAVING TRAVELED TO OR FROM THE DR DURING PERTINENT PERIOD.

b3  
b6  
b7C  
b7E

[REDACTED]

BUREAU IS REQUESTED TO FURNISH THIS INFORMATION TO NEW YORK IN VIEW OF INVESTIGATION BEING CONDUCTED FOR PURPOSE OF DISCREETLY IDENTIFYING FNU [REDACTED] BUREAU IS ALSO REQUESTED TO FURNISH THIS DATA TO MIAMI, IF DEEMED APPROPRIATE, FOR PURPOSE OF DETERMINING IF [REDACTED] IS PRESENTLY IN MIAMI AND TO DETERMINE THROUGH SOURCES ANY INFORMATION CONCERNING HIS ACTIVITIES IN THE DR.

b6  
b7C

END

FBI SAN JUAN RGR RELAY [REDACTED]

ELR R RELAY

b6  
b7C

TO: SAC,

- Albany
- Albuquerque
- Anchorage
- Atlanta
- Baltimore
- Birmingham
- Boston
- Buffalo
- Butte
- Charlotte
- Chicago
- Cincinnati
- Cleveland
- Columbia
- Dallas
- Denver
- Detroit
- El Paso
- Honolulu

- Houston
- Indianapolis
- Jackson
- Jacksonville
- Kansas City
- Knoxville
- Las Vegas
- Little Rock
- Los Angeles
- Louisville
- Memphis
- Miami
- Milwaukee
- Minneapolis
- Mobile
- Newark
- New Haven
- New Orleans

- New York City
- Norfolk
- Oklahoma City
- Omaha
- Philadelphia
- Phoenix
- Pittsburgh
- Portland
- Richmond
- St. Louis
- Salt Lake City
- San Antonio
- San Diego
- San Francisco
- San Juan
- Savannah
- Seattle
- Springfield

- Tampa
- Washington Field
- Quantico

TO LEGAT:

- Bern
- Bonn
- Buenos Aires
- Hong Kong
- London
- Manila
- Mexico, D.F.
- Ottawa
- Paris
- Rome
- Santo Domingo
- Tokyo

Date SEP 26 1967

RE:

For information     Retention optional     For appropriate action     Surep, by \_\_\_\_\_

The enclosed is for your information. If used in a future report,  conceal all sources,  paraphrase contents.

Enclosed are corrected pages from report of SA \_\_\_\_\_ dated \_\_\_\_\_

Remarks:

*See Buairtel to NY 9/8/67.*

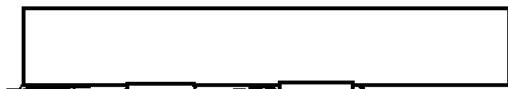

SEARCHED  INDEXED   
 SERIALIZED  FILED   
 SEP 26 1967

b3  
b6  
b7C  
b7E

Enc.  
Bufile  
Urfile





UNITED STATES DEPARTMENT OF JUSTICE

FEDERAL BUREAU OF INVESTIGATION

New York, New York

October 9, 1967

~~SECRET~~

~~NO FOREIGN DISSEMINATION~~

In Reply, Please Refer to  
File No.

Alleged Plan of Cuban Exiles  
To Kidnap Fidel Castro

NY T-1, [redacted]

[redacted] advised that information was  
received [redacted]

b3  
b6  
b7C  
b7D  
b7E

[redacted]

advised that [redacted]

[redacted]

NY T-1 advised that [redacted]

[redacted]

b3  
b6  
b7C  
b7D  
b7E

NY T-1 stated that [redacted]

[redacted]

b3  
b6  
b7C  
b7D  
b7E

NY T-1 advised that [redacted]

[redacted]

b3  
b6  
b7C  
b7D  
b7E

Sources and informants familiar with anti-Castro ac-  
tivities in the New York area advised on September 15, 1967,  
that they had no information concerning the above mentioned  
matter nor had they any information as to the true identity of  
FNU [redacted]

12

b6  
b7C

This document contains neither recommendations nor  
conclusions of the FBI. It is the property of the  
FBI and loaned to your agency; it and its contents  
are not to be distributed outside your agency.

SEARCHED [redacted] INDEXED [redacted]  
SERIAL [redacted] FILED [redacted]  
OCT 10 1967

b3  
b6  
b7C  
b7E

~~GROUP I  
Excluded from automatic downgrading  
and declassification.~~

~~SECRET - NO FOREIGN DISSEMINATION~~

[redacted]



Alleged Plan of Cuban Exiles  
To Kidnap Fidel Castro

[redacted]  
[redacted]  
[redacted] on September 19, 1967, advised that [redacted] of New York City, had been in his office that day and had informed [redacted] that he had recently returned from Santo Domingo, Dominican Republic. [redacted] identified [redacted] as a friend of Dominican President Joaquín Balaguer.

b6  
b7C

[redacted] advised that in his conference with [redacted] [redacted] did not go into any details but had told [redacted] that he was working on a plan of getting rid of Fidel Castro. [redacted] stated that [redacted] indicated to him that something did happen inside Cuba concerning Castro but declined to give [redacted] any information concerning any plan or plot to eliminate Castro.

b6  
b7C

[redacted] also advised on September 19, 1967, that [redacted] has always been anti-Castro in his sentiments and actions and that presumably [redacted] had spent some time in the Dominican Republic, and at one time had been designated as [redacted]

b6  
b7C

[redacted] also stated that [redacted]  
[redacted]

The files of the New York Office reflect that [redacted] [redacted] was interviewed in New York City by Special Agents of the Federal Bureau of Investigation on February 14, 1962. During this interview [redacted] advised that his full name was [redacted] and that he was born on [redacted] At that time [redacted] was residing at [redacted]  
[redacted]

b6  
b7C

During this interview [redacted] stated that he had formerly been employed as [redacted]  
[redacted]

b6  
b7C

~~SECRET - NO FOREIGN DISSEMINATION~~

Alleged Plan of Cuban Exiles  
To Kidnap Fidel Castro

[redacted] This activity [redacted]  
tor, according to [redacted] took place before and during the  
regime of ex-president Fulgencio Batista.

b6  
b7c

[redacted]

During the course of the interview on February 14, 1962,  
[redacted] admitted having spent time in the Dominican Republic and  
also of having received money from [redacted]  
[redacted] for furnishing him with information  
on Dominican Communists. [redacted] also stated that before he  
left the Dominican Republic he had received a letter which  
was dated July 6, 1961, from [redacted]

b6  
b7c

While [redacted] was in the Dominican Republic he or-  
ganized an anti-Cuban movement which he called "Movimiento  
Revolucionario Cubano (Cuban Revolutionary Movement) (MRC)".  
A letterhead of the MRC reflected that this organization had  
for its motto, "Against the Fidelista-Soviet Tyranny Which  
Opposes Our Dear Fatherland". [redacted]

b6  
b7c

[redacted] While  
[redacted] was in the Dominican Republic he also spoke over the  
radio on Radio Caribe and La Voz Del Tropico at various times,  
and all his talks were of an anti-Castro nature.

~~SECRET - NO FOREIGN DISSEMINATION~~

DIRECTOR, FBI

OCT 9 1967

SAC, NEW YORK [redacted] (c)

ALLEGED PLAN OF CUBAN EXILES TO KIDNAP FIDEL CASTRO

[redacted] (OO: NY)

b3  
b6  
b7C  
b7E

ReBuairtel dated 9/8/67, captioned as above, enclosing a copy of [redacted]

Enclosed herewith for the Bureau are 12 copies of a LHM setting forth the results of investigation conducted in this matter. An extra copy is furnished to the Bureau for dissemination to Legat, Santo Domingo.

Information copies are also being sent to Miami, San Juan and WFO.

NY T-1, mentioned in enclosed LHM, is [redacted]

b3  
b7E

For the information of the Bureau, [redacted]

[redacted]

b3  
b6  
b7C  
b7E

Sources and informants, who were contacted negatively regarding (FNU) [redacted] on 9/15/67 are identified as [redacted]

b6  
b7C  
b7D

A review of NY indices fails to reflect any information identifiable with [redacted]

b6  
b7C

From information contained in enclosed LHM, as furnished by [redacted], it would appear that [redacted]

b6  
b7C

- 3-Bureau (Encls. 12) (RM)
- (1-Legat, Santo Domingo)
- 1-Miami (Encl. 1) (Info) (RM)
- 1-San Juan (Encl. 1) (Info) (RM)
- 1-Washington Field (Encl. 1) (Info) (RM)
- 1-New York

[redacted] (7)

[redacted]

SEARCHED [redacted] INDEXED [redacted]  
SERIALIZED [redacted] FILED [redacted]

OCT 10 1967

[redacted]

b3  
b6  
b7C  
b7E

b3  
b7E

[Redacted]

[Redacted] is possibly identical with [Redacted]  
[Redacted]

b3  
b6  
b7C  
b7E

The enclosed LHM has been classified "~~Secret-No~~  
~~Foreign Dissemination~~" because it contains information [Redacted]  
[Redacted]

SAC, New York [redacted]

10/18/67

Director, FBI [redacted]

b3  
b7E

**ALLEGED PLAN OF CUBAN EXILES  
TO KIDNAP FIDEL CASTRO**

[redacted]

Reur closing letter 10/9/67 with enclosure. This letter indicated that [redacted] may be identical with [redacted]

b3  
b6  
b7C  
b7E

[redacted]

Furnish copy of enclosure to relet to [redacted] locally.

b7E

New York bring activities of [redacted] up to date. When investigation completed, submit recommendations relative to interview. Submit results under [redacted] caption.

b6  
b7C

Miami review its indices to be certain that New York has all pertinent information concerning [redacted]

b6  
b7C

The attention of New York is directed to WFOairtel 7/23/64, captioned "Cuban Exile March to Washington, D. C., July 21, 1964, [redacted]" with enclosure. The enclosure on page seven contains information pertaining to [redacted]

b3  
b6  
b7C  
b7E

- 2 - Miami
- 1 - San Juan
- 1 - WFO
- 1 - Santo Domingo

[redacted]

[redacted]

SEARCHED [redacted] INDEXED [redacted]  
SERIALIZED [redacted] FILED [redacted]

OCT 19 1967

[redacted]

[redacted]

b3  
b6  
b7C  
b7E

CONSOLIDATED  
Date: AUG 12 1971  
Initials: [redacted]

NR012 WA CODE

221PM URGENT 12-22-72 [ ]

b6  
b7C

TO: MIAMI

NEWARK

NEW YORK

SAN JUAN

WASHINGTON FIELD

FROM: FOR THE ACTING DIRECTOR, FBI 1P

W. MARK FELT

ACTING ASSOCIATE DIRECTOR [ ]

b3  
b7E

VISIT TO CANADA OF PREMIER FIDEL CASTRO, 12/25-26/72; [ ]

[ ] HAS ADVISED THAT [ ]

[ ]

b7D

IN VIEW OF POSSIBILITY ANTI-CASTROITES WILL BECOME AWARE OF CASTRO'S VISIT TO CANADA AND ATTEMPT TO TAKE SOME POSITIVE ACTION AGAINST HIM, RECIPIENTS SHOULD BE ALERT TO ANY INFORMATION INDICATING SUCH INDIVIDUALS ARE PROCEEDING TO CANADA DURING PERTINENT PERIOD. ADVISE BUREAU OF SUCH DATA BY TELETYPE SUITABLE FOR DISSEMINATION. END AND PLS ACK FOR THREE

SAT FBI WFO ACK FOR NR007 NR009 NR012 [ ]

b3  
b6  
b7C  
b7E

[ ]  
12/22/72  
[ ]  
[ ]  
[ ]

ACTING DIRECTOR, FBI [redacted]

1/26/73

SAC, WFO [redacted] (RUC)

b3  
b7E

VISIT TO CANADA OF PREMIER FIDEL  
CASTRO, 12/25-26/72

[redacted]

As no information was developed by WFO regarding captioned visit and as the visit is now completed, this matter is being closed.

[redacted] 2- Bureau  
1- WFO  
[redacted]  
(3)

[redacted]

[redacted]  
[redacted]  
FILE STRIPPED  
Date: 2/1/73  
[redacted]

[redacted]  
Searched [redacted]  
Serialized [redacted]  
Indexed [redacted]  
Date: 4/4/73  
[redacted]

b3  
b6  
b7C  
b7E

Airtel

To: SAC, New York

6/25/73

From: Acting Director, FBI

POSSIBLE ATTENDANCE OF CUBAN  
PRIME MINISTER FIDEL CASTRO AT  
UNITED NATIONS GENERAL ASSEMBLY,  
FALL, 1973



NI

b3  
b7E

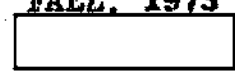

an

b3  
b7E

item from the newspaper "El Nacional", Caracas, Venezuela, dated  
6/17/73.

The newspaper reported that a meeting between Venezuelan  
President Rafael Caldera and Fidel Castro was being planned and that  
the meeting reportedly would be held in New York City while both were  
attending the United Nations General Assembly. It was also stated  
that President Caldera would probably not stop over in Havana en route  
to the United Nations.

The Bureau has received nothing from other agencies con-  
cerning Castro's visit to the U.S. New York should be most alert to  
any information indicating such a trip will be made and should main-  
tain close liaison with the U.S. Mission to the United Nations in this  
regard. Other recipients of this airtel should be alerted by New York  
if any positive information is developed concerning the visit. De-  
tailed instructions will be issued in the event the trip does materi-  
alize.

- 1 - Miami
- 1 - San Juan
- ① - WFO
- 1 - Mexico

b3  
b6  
b7C  
b7E

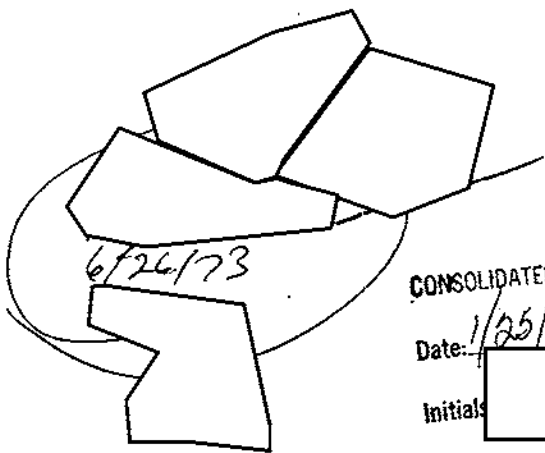
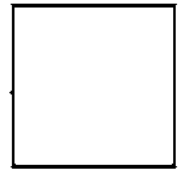

CONSOLIDATED  
Date: 6/25/74  
Initials



SEARCH SERIAL [redacted] INDEXED [redacted]  
JUN 25 1973  
FBI - WASH. FIELD OFFICE

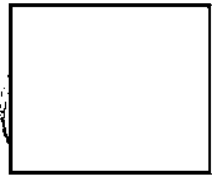



FEDERAL BUREAU OF INVESTIGATION  
FOI/PA  
DELETED PAGE INFORMATION SHEET  
FOI/PA# 1362425-000

Total Deleted Page(s) = 28

- Page 33 ~ b6; b7C;
- Page 36 ~ b6; b7C;
- Page 46 ~ Duplicate;
- Page 82 ~ b3; b6; b7C; b7E;
- Page 83 ~ b3; b6; b7C; b7E;
- Page 84 ~ b3; b6; b7C; b7E;
- Page 85 ~ b3; b6; b7C; b7E;
- Page 86 ~ b3; b6; b7C; b7E;
- Page 96 ~ b6; b7C; b7D;
- Page 109 ~ b3; b7E;
- Page 110 ~ b3; b7E;
- Page 111 ~ b3; b7E;
- Page 115 ~ b3; b6; b7C; b7E;
- Page 118 ~ b3; b6; b7C; b7E;
- Page 119 ~ b3; b6; b7C; b7E;
- Page 142 ~ b3; b6; b7C; b7E;
- Page 143 ~ b3; b6; b7C; b7E;
- Page 145 ~ Duplicate;
- Page 157 ~ b3; b6; b7C; b7E;
- Page 158 ~ b3; b6; b7C; b7E;
- Page 175 ~ Duplicate;
- Page 176 ~ Duplicate;
- Page 177 ~ Duplicate;
- Page 178 ~ Duplicate;
- Page 179 ~ Duplicate;
- Page 180 ~ Duplicate;
- Page 185 ~ Duplicate;
- Page 186 ~ Duplicate;

XXXXXXXXXXXXXXXXXXXXXXXXXXXXX  
X Deleted Page(s) X  
X No Duplication Fee X  
X For this Page X  
XXXXXXXXXXXXXXXXXXXXXXXXXXXXX

# FEDERAL BUREAU OF INVESTIGATION

~~CONFIDENTIAL~~

FORM NO. 1  
THIS CASE ORIGINATED AT **NEW YORK CITY**

REPORT MADE AT <b>MIAMI</b>	DATE WHEN MADE <b>JAN 4 1956</b>	PERIOD FOR WHICH MADE <b>11/15, 21-24, 27-29; 12/1, 2, 5, 6, 7, 9, 10, 13, 20, 21/55.</b>	REPORT MADE BY [redacted]
TITLE <b>CHANGED: 7 FIDEL ALEJANDRO CASTRO RUZ, wa. Fidel Castro Ruz; JUAN MANUEL MARQUEZ</b>			CHARACTER OF CASE [redacted]

b3  
b6  
b7C  
b7E

### SYNOPSIS OF FACTS:

FIDEL CASTRO and MANUEL MARQUEZ in Miami during November and December, 1955. CASTRO was principal speaker at public meetings held 11/20/55, Miami, 11/27/55 Tampa, and 12/7/55 Key West, Fla. CASTRO advocated overthrow of FULGENCIO BATISTA, President of Cuba, by force, unless BATISTA gives up reign of his government within near future. CASTRO took up collections of money and insinuated that this might be used to purchase arms, but indicated he would not violate any laws of U.S. PATRIOTIC CLUBS OF JULY 26 organized Tampa and Miami, Fla. CASTRO departed U.S. at Miami for Mexico on 12/10/55 and indicated he hopes to return to U.S.

- P -

### DETAILS:

The title of this case is being marked Changed to denote subject's full name, FIDEL ALEJANDRO CASTRO RUZ. He is commonly known as FIDEL CASTRO.

### AT MIAMI, FLORIDA

On November 15, 1955 Miami Confidential Informant T-1, who has furnished reliable information in the past,

*Correction per*  
0-17 [redacted] 1/12/56

APPROVED AND FORWARDED: [redacted]	SPECIAL AGENT IN CHARGE [redacted]	DO NOT WRITE IN THESE SPACES	
COPIES OF THIS REPORT 8 - Bureau [redacted] (RM) 2 - Miami [redacted] <i>Open</i> (COPIES CONTINUED PAGE 2)		SEARCHED [redacted] INDEXED [redacted] SERIALIZED [redacted] FILED [redacted] JAN 5 1956 FBI - WASHINGTON	[redacted]

b3  
b6  
b7C  
b7E

PROPERTY OF FBI--This report is loaned to you by the FBI, and neither it nor its contents are to be distributed outside the agency to which loaned.

~~CONFIDENTIAL~~



b3  
b7E

COPIES THIS REPORT (Cont'd)

- 1 - U.S. Customs, Miami (RM)
- 1 - INS, Miami (RM)
- 3 - New York (RM)
- ② - Washington Field (RM)

\* \* \* \* \*

advised that FIDEL CASTRO RUZ and JUAN MANUEL MARQUEZ arrived in Miami sometime during the preceding week from Mexico City, where they had been attempting to collect funds for the avowed purpose of overthrowing the BATISTA Government in Cuba.

T-1 said that



had been promoting CASTRO and MARQUEZ in Miami.

b6  
b7C

With reference to it is to be noted that during the investigation of the case entitled "CARLOS PRIO SOCARRAS, ET AL,

during 1953-1955, it was determined that was closely associated with PRIO and registered under the Registration Act in connection with these activities.

b3  
b6  
b7C  
b7E

T-1 said that information had come to his attention to the effect that CASTRO had been "passing the hat" around Miami, especially in factory neighborhoods where Cubans are employed, and that CASTRO had been soliciting this money for the alleged purpose of overthrowing BATISTA. T-1 said that CASTRO left Cuba, in about July, 1955, after having been released from prison under the new Amnesty Law, granting freedom to political prisoners.

He pointed out that CASTRO had led the attack against the Cuban military hospital barracks at Moncado, Santiago de Cuba, on July 26, 1953; that this attack resulted in the death of quite a few individuals on both sides and that as a result, CASTRO was tried, found guilty and sentenced to prison.

T-1 said that following his release from prison, FIDEL

[REDACTED]

b3  
b7E

CASTRO remained in Cuba for about one month, during which time the Cuban Government granted him full freedom, after which CASTRO voluntarily departed from Mexico, where he remained for a while and then proceeded to New York City from Mexico.

T-1 said that CASTRO planned to hold a public meeting at the Flagler Theater, Miami, on November 20, 1955 and had been passing out leaflets, advertising this meeting. T-1 said that CASTRO had more or less been inviting his arrest by the police so that he would be a martyr in the eyes of his followers.

T-1 said that CASTRO claimed to lead an organization known as the PATRIOTIC CLUBS OF JULY 26; that he claimed to have a large following in Cuba and that he indicated he planned to organize chapters of this club in Miami and Tampa, and to have already organized such clubs in New York City and other places visited by him in the United States. T-1 said that actually, in his opinion, CASTRO does not represent any real following and that he merely represents himself. T-1 suspected that CASTRO was collecting funds for his own personal use.

T-1 said that CASTRO does have some following among members of one faction of the Orthodox Party of Cuba, among whom locally is [REDACTED]

b6  
b7C

T-1 said that CASTRO is divorced from his wife, who is reportedly living in the Fort Lauderdale, Florida area. He said that his wife was [REDACTED]

T-1 said that [REDACTED]

b6  
b7C  
b7D

The November 11, 1955 issue of the "Diario Las Americas", a Spanish language newspaper, Miami, carried an article entitled "FIDEL CASTRO WILL SPEAK AT THE FUNCTION AT THE FLAGLER THEATER ON THE 20TH", by JOSE FADUL. This article reported an interview of CASTRO, which is quoted in part as follows:



"From time immemorial and even at present the peoples of America have been faced with an unavoidable dilemma; the choice between constitutional laws and tyrannical arbitrariness; between AUTOCRATIC government and government created by the people and sustained by that free will of the citizen who has no despotic sponsors and who has his foundation in juridical institutions in which human right is not subservient to the will of an uncontrolled government. In what conditions do the various countries of America find themselves? This is an important question for free man! The answer is discouraging. However, it is a consolation to know that there are still men who are prepared to sacrifice all, their families, their tranquility and their lives, if necessary, for that famous LIBERTY which some have made the mistake of wanting to snatch from them." \* \* \* \* \*

" \* \* \* \* \* This is the fine city of Miami and this is the great country, the example of liberty and justice where all the persecuted come to enjoy their fraternal and sure shelter. It is delightful to see how human rights are respected. We will imitate the great people of the United States of America, the example of democracy and work in the world. We sincerely believe in their democratic ideal; it is for this reason that we come this far." \* \* \* \* \*

" \* \* \* \* \* The date of recovery has already been set. We shall fight without rest to achieve it in our country as well as outside. We shall go to every corner of the world; our ~~voice will be found wherever there is a Cuban.~~ This is not a political movement. This is a movement of all Cubans without distinction of political parties; of the Cubans who do not accept the condition of a government unable to make the Cuban people happy. Cuban patriotism does not need to be awakened and when duty calls, the answer is without conditions. The unification of all will be Cuba's salvation. Therefore, this general movement that gains its sustenance from the memory of the martyrs of July 26, 1953, cannot fail." \* \* \* \* \*

The November 13, 1955 issue of the "Diario Las Americas" carried an article entitled "BATISTA WILL NOT BE ABLE TO SUPPORT THE PRESENT SITUATION, SAYS THE REVOLUTIONARY CASTRO", by RAMON COTO, of "Diario Las Americas".



This article announced a meeting to be held by CASTRO at the Flagler Theater November 20th.

The following quotations from CASTRO were extracted from this article:

"It is not possible for a country in which there are more than one and a half million people unemployed, in which the civil guarantees of the citizens are trampled upon daily, and the people humiliated and annoyed, to be able to support the Dictator BATISTA any longer. Unfortunately, this is the picture displayed by the Republic, that was founded by our apostle JOSE MARTI, for the good of all Cubans and not for a group of paid assassins to get in their hands, making their own the powers of the State, usurping the right of governing over the sovereign will of the people." \* \* \* \* \*

"The purpose of our battle is not only to throw from power those who have no right to it, but also all the earlier evils which the Republic has suffered.

"It is now that the voice of the Cubans who have found it necessary to leave their country because of the economic situation existing in Cuba will become louder. The following are the real Cuban exiles: The economic exiles; those who are in the different cities of the United States at this time come to the number of tens of thousands, and the number will increase while BATISTA retains power. As in 68 and 95, these Cubans are prepared to cooperate for the definitive achievement of the ideals of the "July 26 Movement", because everybody wants to return to his country some day, when he can live in it honorably. More than 2,000 persons will aid by means of a small weekly allotment, in New York alone. In the way of encouraging information, we have the spontaneous offer of a sympathetic enthusiast who has donated for a period of six months a hall with a capacity for 300 couples, where dances will be held every Sunday for the benefit of the movement. Everything that is obtained through this will be used to augment the funds for fighting BATISTA as was done in the fight for Independence. I can assure you that the fight is now going on more forcefully than ever for the recon-

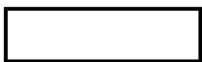

"quest of the public liberties and with all the moral strength that comes from the fact that it is directed by new men at the expense of the people, who as MARTI has said are the real leaders of revolutions." \* \* \* \* \* "with much less than one-tenth of what was spent on those weapons, which never fired a shot, BATISTA could have been deposed."

"No, it is not true that we want revolution at any cost. BATISTA still has an opportunity to avoid one. Let him give up the presidency and hand the power over to Don COSME DE LA TORRIENTE, in order that general elections can then be held without BATISTA, let them pay close attention, without BATISTA!, because if he had any part in these elections, or should preside over them, then the formula would not have our support. We would accept that in order to avoid a civil war, but let it be understood that any form of support for those base politicians of such long standing who only aspire to the satisfaction of their ambitions will always be forcefully repulsed by us, because in the future that we have in mind for Cuba, they will be of no account." \* \* \* \* \*

"The Cubans will give evidence of their rejection of the Batista Government by being present at the meeting at the Flagler Theater... We will await them there with the fervor and the patriotism that is characteristic of them!" \* \* \* \* \*

The November 15, 1955 issue of the Miami Herald carried an article entitled "CUBAN REBEL SEEKS SUPPORT HERE TO OUST BATISTA", by GEORGE SOUTHWORTH, Herald Staff Writer, which reflected that CASTRO was in Miami making plans to topple the government of BATISTA. This article quoted CASTRO as follows, in part:

"We have an organized movement of 100,000 persons. If BATISTA continues to remain in power by force, then there is no other way but to throw him out by force.

"Dictator BATISTA has caused an economical crises in Cuba and the situation is becoming worse all the time. We have the only revolutionary movement that will face the regime."



This article disclosed that CASTRO claimed that he and the people he is organizing in the United States are "staying within the laws of the United States." The article stated that CASTRO admitted that if his revolutionary movement should succeed, he does not know who would take over the presidency "but at least we would call immediate elections and live by the constitution."

On November 15, 1955 T-1 furnished a leaflet printed by the "Club Patriotico July 26 of Miami", which he said had been picked up on the street and turned over to him. This leaflet read in part as follows:

"CUBAN:

"BE PRESENT AT THE BIG PATRIOTIC MEETING WHICH THE CUBAN IMMIGRANTS OF MIAMI ARE ORGANIZING FOR SUNDAY, NOVEMBER 20, at 10:30 A. M. in the FLAGLER THEATER.

"With a fervor, impartiality, and purity of motives similar to 68 and 95, the sons of Cuba are preparing to bring liberty to their people.

"The thousands of countrymen who had to leave their country, persecuted by hunger and political oppression, are not surrendering their desire to return to it and live with honor, and liberty in the land in which they were born, where members of their families, their affections and their sentiments are to be found." \* \* \* \* \*

"MARTI said that the only fixed soil in the universe is the soil on which one is born.

"However, to have a fatherland it must be won.

"No decent Cuban can remain detached from such a noble task. It is impossible for faith to falter. The great task of redeeming Cuba is today in the hands of new men, clean and without complicities or compromises with the past. That task is not now the work of a caudillo or of a party, but rather the ideal and the program of a people.



[redacted]

b3  
b7E

"We want liberty, honor, and bread for all Cubans.

"The organization of the meeting will be in the hands of the fighters of Moncada, the young warrior, who is tireless, honest and honorable, and in whom the people of Cuba have placed their hopes.

"CUBAN:

"If Cuba pains you, if Cuba concerns you, if you love Cuba, do not fail to come to the FLAGLER THEATER on SUNDAY, NOVEMBER 20, at 10:30 A. M. This is no time for hesitation, no time for 'buts'. The Cuban is not a coward, the Cuban is not base, the Cuban has never been indifferent; the Cuban is rebellious, the Cuban is worthy, the Cuban is civically minded. His destiny cannot be frustrated; no one can ever take away his freedom and go unpunished. Such is the concept which the world should have of the Cuban. Let us once more demonstrate that it is so."

On November 20, 1955 SAs [redacted] and [redacted] attended an event at the Flagler Theater, identified as the "Club 26 de Julio de Miami" (July 26 Club of Miami). The theater was filled to near capacity by individuals of the Latin American race, and it would appear that a majority of them were Cubans.

b6  
b7C

This event began at approximately 11:00 A. M. and broke up at approximately 2:30 P. M.

SA [redacted] observed the following:

b6  
b7C

[redacted] was identified as [redacted] the aforementioned organization, with [redacted]

There were several speeches made prior to that of FIDEL CASTRO and those making same were identified as follows:

[redacted]

b6  
b7C

[REDACTED]

b3  
b7E

[REDACTED]

JUAN MANUEL MARQUEZ

[REDACTED]

b6  
b7C

There was frequent applause during this act on the part of the audience. Shortly after the meeting began, a collection was taken from those who desired to contribute. It was noted that several hundred dollars appeared to have been collected.

At one point during the collection proceedings, [REDACTED] in his speech, informed that the purpose of the collection was to fight the dictator under a plan to be determined and directed by FIDEL CASTRO.

b6  
b7C

During the speech of JUAN MANUEL MARQUEZ, he asked the audience to bring about the defeat of BATISTA in 1956. He then asked the audience to stand and take an oath that they would support such a movement. The audience did swear to support such a movement.

All orators were in accord for BATISTA's abandoning the presidency and then permitting free elections without fear of official pressure.

FIDEL CASTRO thanked the audience for their fine spirit in support of funds which had been requested. He pointed out that this money would be used toward bringing about the defeat of BATISTA in 1956.

CASTRO was critical of certain of those individuals who had given large sums to purchase arms in furtherance of a revolutionary plot against BATISTA. He branded this money as "stolen" money and that he wanted no part of it.

CASTRO said he could not predict when he would return to Cuba in 1956, nor whether it would be with guns, or sufficient

[redacted]

b3  
b7E

morale to defeat BATISTA.

CASTRO pointed out that 26,000 Cuban Nationals had come to this country from 1944 to 1952. From 1952 to present, an equivalent number had entered this country. It was CASTRO's plan or suggestion that each one of the incoming individuals entering from Cuba could be turned into a combatant to fight against BATISTA in support of the cause of liberty.

CASTRO related that Cuba would be free in 1956, or "we'll die".

On December 2, 1955 Miami Confidential Informant T-2, who has furnished reliable information in the past, reported substantially the same information concerning the November 20, 1955 meeting at the Flagler Theater. This Informant reported that CASTRO, at one point in his speech, stated very dramatically, "We would rather go to the revolution with 10 rifles bought with the money of the people than with 10,000 bought by the rich politicians. "

He also reported that [redacted] made a speech in which he condemned the American Ambassador to Cuba for giving a decoration to General TABERNILLA, the Chief of Staff of the Cuban Army. He also condemned the Government of the United States for furnishing planes, tanks and arms to the Cuban Government.

b6  
b7C

T-2 said that FIDEL CASTRO advocated the overthrow of BATISTA by force unless BATISTA gives up soon and turns over the reigns of his government to TORRIENTE. He also reported that FIDEL stated that he needed money to buy arms but he avoided using the word revolution and he did not indicate where he intended to purchase these arms.

On November 28, 1955 T-1 furnished a number of photographs taken of individuals on the speaker's rostrum during the above described meeting at the Flagler Theater. In one of these photographs, he identified those present as:

1). [redacted]

b6  
b7C

[redacted]

b3  
b7E

[redacted]

b6  
b7C

2). JUAN MANUEL MARQUEZ.

[redacted]

b6  
b7C

4). FIDEL CASTRO.

[redacted]

b6  
b7C

6). [redacted]

7). [redacted] whom he described as being [redacted]

b6  
b7C

[redacted]

Other photographs furnished by T-1 showed other poses of the above individuals on the stage at the Theater. Another photograph showed what appears to be several hundred people seated in the audience. T-1 said that most of the people who attended this meeting were Cubans, Puerto Ricans and Dominicans.

The November 22, 1955 issue of the Miami Herald carried an article entitled "FOES DEFIED BY BATISTA". This article disclosed that BATISTA stated that he would remain in office until his term expires in 1958, despite threats and demands from his opposition that he resign. [redacted] a spokesman for BATISTA, ridiculed a threat by FIDEL CASTRO to overthrow the government of BATISTA if he refuses to resign.

b6  
b7C

On November 23, 1955 [redacted] Investigator, Immigration and Naturalization Service, Miami, advised that FIDEL ALEJANDRO CASTRO RUZ had come into the INS office, at which time he was interrogated concerning his status as an alien.

[redacted]

b3  
b7E

[redacted] advised that CASTRO stated he was then residing at 624 S. W. 14th Avenue, Miami; that he was born August 13, 1926 at Incueto, Oriente, Cuba, and last entered the United States at San Antonio, Texas, October 20, 1955 as a B-2 visitor to November 19, 1955, destined to [redacted] Care of [redacted] [redacted] said that according to CASTRO's papers, he was accompanied by [redacted] who was destined to [redacted]

b6  
b7C

[redacted] said that CASTRO's papers reflected that he had made application for an extension at New York on October 31, 1955, but that his application was denied and he was granted until December 10, 1955 in which to depart.

b6  
b7C

CASTRO exhibited to INS his passport, No. 17702, issued June 23, 1955, valid for 5 years. This passport contained a Non-immigrant Visa B-2, No. V-1200944, issued at the American Embassy in Mexico City, Mexico, October 4, 1955, and valid for a single admission.

CASTRO told INS that his purpose in coming to the United States on October 20, 1955 was to visit his son, and at the same time, to comply with invitations which Cubans in New York, Miami, Tampa and Key West had made, for the purpose of explaining the situation in Cuba and his ideas and plans as leader of the MOVEMENT OF THE 26TH OF JULY, 1953.

CASTRO described this as a movement to "fight today against the dictatorship of BATISTA in Cuba, recovering the fallen morale, maintaining the recovery, to accept moral aid and economic aid which they have suffered from lack of."

[redacted] said that CASTRO stated that he was the Chief of the MOVEMENT OF THE 26TH OF JULY, 1953. CASTRO said that on July 26th, 16 months after BATISTA took over the government of Cuba, a group of Democratic youths initiated an armed movement to recover the liberties which had been taken away from the people, and on that occasion their action was not successful and BATISTA ordered the assassination of 80 young prisoners, who today are martyrs and for that reason, members of the organization called the MOVEMENT OF JULY 26TH, 1953.

b6  
b7C

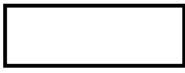

b3  
b7E

CASTRO claimed to be the elected representative of that group. He said that the other officers are in Cuba and he declined to give their names on the grounds that they would be persecuted if their identities were known in Cuba.

When questioned concerning the aims and purposes of this movement, CASTRO stated that the purpose was to remove the government which tyrannizes the people, recover the liberty of the people and the democratic system which was taken away by BATISTA.

CASTRO related that after the attack on the fort at Moncada failed, he, along with others, were taken prisoner and many killed, although he, himself, was spared and in the month of May, 1955, was liberated when the Cuban Government declared political amnesty in order to quiet the people. He stated that he remained in Cuba for approximately 7 weeks after he was released before he had to leave Cuba for Mexico. He said that the Cuban Government canceled the radio programs on which he had been appearing to tell his story. He claimed that he cannot now return to Cuba.

When questioned as to whether or not his MOVEMENT OF JULY 26TH was connected with any other political organization, he answered that it is connected with the Orthodox Party of Mr. EDWARD CHIVAS, now deceased, but whose brother is the present president.

When questioned as to whether or not the MOVEMENT OF JULY 26TH has a branch organization in Miami, CASTRO replied that it had a large patriotic group whose officers are:

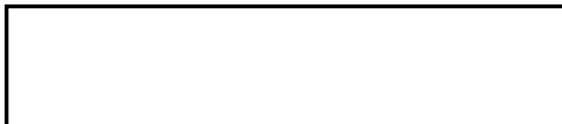

b6  
b7C

 . CASTRO said that the Miami organization of this movement is a public club, not secret, and is going to have 2,000 members.

When questioned as to his activities since last entering the United States, CASTRO said that he ~~visited~~ visited Cuban groups



b3  
b7E

upon invitation to give two public talks and had given statements to the press. When questioned as to how his group proposed to overthrow the Government of BATISTA, CASTRO stated that he wanted to do this through Cuban public opinion and through having other American countries to renounce BATISTA and have the power of the government turned over to Colonel DON COSME DE LA TORRIENTE, a Veteran of the War of Independence, so that he could preside over an honest election.

When questioned if he intended to overthrow BATISTA by force, CASTRO replied in the negative, stating that he intended to overthrow it first through pressure of public opinion, but "if BATISTA refuses to turn back the rights to the people of Cuba, we will have to exercise the right which all the oppressed people of the world have used to recover their liberty. If BATISTA does not give up, then the people of Cuba will have a revolution in which event we will be with the people. If BATISTA does not give up to the pressure of public opinion, I do not deny that we will have to use some force, but actually we are not using force nor advocating the use of force at this time."

CASTRO disclosed that other speakers at the Flagler Theater in addition to himself included

b6  
b7C

[REDACTED] JUAN MANUEL MARQUEZ, and others whose names he was unable to recall.

He said that none of these individuals advocated in their speeches the armed overthrow of the Cuban Government, but that they had said, as did he, himself, that "we had to utilize civic forces before using revolutionary force." He said that the monies collected were to be used for publicity purposes and the general fight.

He claimed that some of this money had been sent to Cuban exiles in Mexico, and he denied that he was purchasing any arms for use in Cuba. He claimed that he has remained within the law in the United States, that he planned on giving talks in Tampa and Key West. While in Tampa, he said that he could be reached at the home of [REDACTED]

b6  
b7C

[REDACTED]

b3  
b7E

He claimed that he had never been a member of any organization affiliated with the Communist Party.

[REDACTED] said that CASTRO also claimed that he would leave the United States by December 10, 1955.

b6  
b7C

AT TAMPA, FLORIDA

On November 23, 1955 Miami Informant T-1 advised that CASTRO was leaving Miami the following day for Tampa and would be accompanied by JUAN MANUEL MARQUEZ, [REDACTED]

b6  
b7C

T-1 furnished a one-page leaflet in the Spanish language, announcing a meeting to be held at the Italian Union Theater in Tampa, on November 27, by the PATRIOTIC CLUB OF JULY 26 OF TAMPA. In this leaflet CASTRO was described as "the leader of the Cuban revolution".

On November 27, 1955 T-1 reported that the following individuals accompanied CASTRO to Tampa:

[REDACTED]

b6  
b7C

T-1 said that he had received information to the effect that [REDACTED]

b7D

The November 27, 1955 issue of the "Tampa Tribune, carried an article entitled "ITALIAN CLUB BARS THEATER TO LEADER



[redacted]

b3  
b7E

OF CUBAN REVOLT", which reflected that the scheduled meeting of CASTRO's group had been canceled by the Italian Club because the meeting was political in nature.

This article quoted CASTRO as stating, upon being interviewed, "I cannot say I will buy arms with it. All I can say is that it will be used to help the movement. What do you want me to say?", in referring to money collected during an afternoon meeting in Tampa.

The November 26, 1955 issue of the "Tampa Tribune" carried an article entitled "ANTI-BATISTA CUBAN COMES HERE TO SEEK REVOLT FUNDS", by TOM O'CONNOR, Staff Writer, who stated that CASTRO had come to Tampa under the auspices of a recently formed society in Tampa, known as the 26 JULY CLUB, provisionally headed by VICTORIANO MANTEIGA, publisher of a Spanish language newspaper. CASTRO was quoted as stating, "We will try every legal means to oust the tyrant BATISTA from Cuba, but failing in that we will take to arms."

The Tampa meeting was held at 3:00 PM on Sunday, November 27, 1955, at the CIO Hall, 1226 - 7th Avenue, Tampa. SAs [redacted] and [redacted] who were present, noted that several announcements were made, prior to the speeches, by [redacted] described as [redacted] of the PATRIOTIC CLUB OF JULY 26 OF MIAMI. [redacted] referred to CASTRO as "the leader of the Cuban revolution".

b6  
b7C

As soon as CASTRO arrived, the meeting was begun with the playing of a recording of the "Star Spangled Banner", followed by a recording of the Cuban National Anthem. [redacted] and [redacted] of Miami, were the first speakers. Third speaker was [redacted] of Tampa, [redacted] and introduced as [redacted] of the PATRIOTIC CLUB OF JULY 26 OF TAMPA. Nothing significant was said in these speeches.

b6  
b7C

JUAN MANUEL MARQUEZ, the fourth speaker, was described as a companion of FIDEL CASTRO for many years. He compared FIDEL CASTRO with the Cuban Hero, JOSE MARTI. He praised CASTRO for his devotion to the cause of liberty and asked for contributions





b3  
b7E

to further their cause. In doing this, he stated, "There is no use in equivocating. The money is needed to buy rifles to overthrow the dictatorship of BATISTA." This statement was greeted by applause and shouts from the audience. A collection was then taken up.

The final speaker was FIDEL CASTRO. He discussed conditions in Cuba, alleging abuses by the present authorities against businessmen and all citizens. He declared that it is the duty of every Cuban who loves liberty to take up the fight against the dictatorship of Cuba or, if he cannot take part in this fight, then to at least support it. CASTRO said that he had not come to solicit help or contributions from American citizens, but only from Cubans living in exile.

He pledged that, "Our movement will end only when tyranny has ended or when we die.". He said that his present purpose is peaceful and that he and his associates have done nothing to violate the laws of the United States, for which they have respect. He said their purpose is to compel BATISTA to resign and call elections; that BATISTA could in this way avoid any bloodshed. He said that if BATISTA did not resign, then revolution would be the only course left for them to follow.

Agents  and  estimated that this meeting was attended by approximately 150 to 200 individuals.

b6  
b7C

Miami Confidential Informant T-3, who has furnished reliable information in the past, reported on November 28, 1955

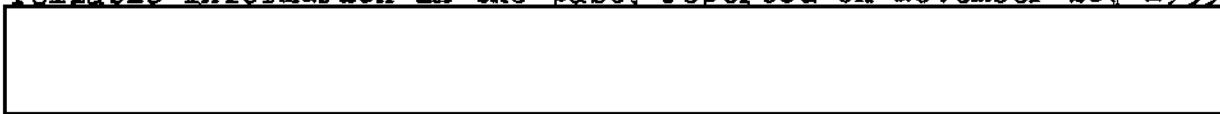

b6  
b7C  
b7D

SA  obtained one copy of a pamphlet consisting of 28 pages, entitled "LA HISTORIA ME ABSOLVERA", by Dr. FIDEL CASTRO. This pamphlet, which is in the Spanish language, is being transmitted to the Bureau as an enclosure of this report.

b6  
b7C

CASTRO announced at the Tampa meeting that he intended to hold a similar meeting in Key West on December 2, 1955; that he would return from Tampa to Miami on November 28, 1955 and proceed from Miami to Key West.

[REDACTED]

b3  
b7E

On November 29, 1955 T-1 advised that FIDEL CASTRO and his immediate associates returned from Tampa to Miami. [REDACTED]

[REDACTED]

b6  
b7C  
b7D

T-1 said that [REDACTED]

[REDACTED]

b6  
b7C  
b7D

T-1 said that [REDACTED]

[REDACTED]

AT KEY WEST, FLORIDA

Miami Informant T-2 reported that FIDEL CASTRO and several of his associates were in Key West on December 2, 1955 for the alleged purpose of holding a meeting. T-2 learned that this meeting was held at an unidentified private home; that less than 100 persons were present, and that a disappointing collection had been taken.

T-2 reported on December 9, 1955 that FIDEL CASTRO succeeded in holding a public meeting in the parking lot of a dog track, outside the City Limits of Key West, after having been refused permission to hold a similar meeting at the Key West Elks Club. T-2 obtained in Key West a leaflet in the Spanish language announcing the meeting to be held at 8:30 PM, December 7, 1955, at the Elks Club in Key West. This meeting announced the speaker as Dr. FIDEL CASTRO.

[redacted]

b3  
b7E

T-2, who was present at the meeting at the dog track, stated that [redacted] was the first speaker who introduced some of the others present. JUAN MANUEL MARQUEZ then spoke, complaining that local Cuban officials had used influence in order to prevent the meeting from taking place at the Elks Club.

b6  
b7C

FIDEL CASTRO then spoke, telling his audience about the trouble he had encountered while in the United States in attempting to hold the meetings. He took up a collection and stated the funds were to be used to help finance his movement. He made no mention of guns or of revolution. He said that he was winding up 7 weeks of campaigning and that "We are leaving for other lands where we are being awaited."

T-2 said that the meeting was attended only by about 120 persons and that CASTRO seemed to be disappointed and was not as vigorous or aggressive as he had been at the Flagler Theater meeting in Miami.

T-1 said that members of CASTRO's group also sold copies of the pamphlet entitled "LA HISTORIA ME ABSOLVERA", by Dr. FIDEL CASTRO, one copy of which T-2 obtained and furnished the Miami Office.

The December 9, 1955 issue of the "Key West Citizen", carried an article entitled "ALLEGED CUBAN PLOTTER SPEAKS HERE WEDNESDAY". This article disclosed that FIDEL CASTRO had held an unpublicized meeting Wednesday night outside the City Limits.

This article disclosed that the Elks Club had canceled arrangements made by CASTRO to hold a meeting there when they became aware of the publicity which had attended CASTRO's meetings held elsewhere.

AT MIAMI, FLORIDA

[redacted] Investigator, INS, Miami, advised on December 10, 1955 that FIDEL CASTRO, accompanied by [redacted] a naturalized citizen, departed Miami at 7:45 PM on Flight 101, Guest Airlines, for Mexico City. [redacted]

b6  
b7C

[redacted]

b3  
b7E

said that CASTRO indicated that he hopes to return to the United States. [redacted] said that there were about 20 people at the Miami International Airport to bid CASTRO farewell.

b6  
b7C

On December 13, 1955 Miami Informant T-1 advised that

[redacted]

b6  
b7C  
b7D

On December 9, 1955 T-2 reported that [redacted] mailing cards to several hundred people in Miami announcing a meeting to take place December 10, 1955 at 3527 N. W. 2nd Street, Miami, under the auspices of the PATRIOTIC CLUB OF JULY 26 OF MIAMI. T-2 learned [redacted] that members of this club are expected to pay dues of \$1.00 per week.

b6  
b7C  
b7D

Informant noted that receipts are signed by FIDEL CASTRO as President. [redacted]

[redacted]

b6  
b7C

[redacted] advised that INS, Miami, possessed no record on JUAN MANUEL MARQUEZ.

- P -

ENCLOSURE TO BUREAU: 1 pamphlet entitled "LA HISTORIA ME ABSOLVERA"

[redacted]

b3  
b7E

ADMINISTRATIVE

Information of interest to United States Customs, Miami, as contained in this report, was furnished currently by SA [redacted] to [redacted] Supervising Customs Agent.

b6  
b7C

T-1 has advised that he has reported all information of interest to United States Customs directly to [redacted]

[redacted]

INFORMANTS

T-1 is [redacted] who was contacted 11/15, 23, 28; 12/13/55, who reported orally to SA [redacted] instant case.

b6  
b7C  
b7D

T-2 is [redacted] who reported orally on 11/21, 23; 12/5/55, and who submitted written reports on 12/6, 9/55 to SA [redacted] and instant case.

T-3 is [redacted] (Confidential Source), who reported orally on 11/28/55 to SA [redacted] at Tampa, Florida, instant case.

b6  
b7C  
b7D

LEADS

WASHINGTON

AT WASHINGTON, D. C.

Will check central records, INS, for pertinent information concerning JUAN MANUEL MARQUEZ and associates of FIDEL CASTRO. MARQUEZ is believed to be currently residing in Miami.

ADMINISTRATIVE PAGE



LEADS (Continued)

MIAMI

AT MIAMI, FLORIDA

Will conduct appropriate investigation to determine if the Miami and Tampa chapters of this organization are active and whether or not officers or members are acting in violation of the Registration Act.

REFERENCES

Bureau airtel to New York City, 11/23/55.  
Bureau letter to New York City, 12/2/55.  
Bureau letter to Miami, 12/7/55.  
Miami airtel to Bureau 11/18, and 28/55.  
Miami teletype to Bureau, 12/10/55.

ADMINISTRATIVE PAGE (Cont'd.)

(Title) FIDEL ALEJANDRO CASTRO RUZ

(File No.) [redacted]

1. Photos of Fidel Alejandro Castro Ruz. (Filed 2/27/56) pgd.

2. Photo of MARIE MARQUEZ RODRIGUEZ (filed 5-9-56) [redacted]

3. 2 photos of [redacted] (filed 4/15/59) [redacted]

4. 2 photos of [redacted] (filed 4/15/59) [redacted]

5. Photostat of lit. envelope to: [redacted] from [redacted] (filed 5-22-59) [redacted]

b3  
b6  
b7C  
b7E

**DO NOT DESTROY; HISTORICAL  
VALUE, NATIONAL ARCHIVES**

**Disposition:**

3. 1 photo to SM.P.D. 4-16-59 [redacted]

4. 1 photo to SM.P.D. 4-16-59 [redacted]

b6  
b7C

**DO NOT DESTROY; HISTORICAL  
VALUE, NATIONAL ARCHIVES**

SEARCHED	INDEXED
SERIALIZED	FILED
FEB 27 1956	
FBI - WASHINGTON	

b3  
b6  
b7C  
b7E



File No.

b3  
b7E

Date Received 2-7-56

From The N.Y. office  
(Name of Contributor)

See N.Y. Let dated 2/3/56  
(Address of Contributor)

By   
(Name of Special Agent)

b6  
b7C

To Be Returned Yes ( )  
No (x)

Description:

Photos of Fidel  
Alejandro Castro Ruz.



FIDEL ALEJANDRO CASTRO RUZ  
wa: Fidel Castro Ruz  
6 ft.  
Hair, bronw, eyes, brown  
Race: White  
DOB: Aug. 13, 1926  
POB: Cueto, Oriente, Cuba

*Fidel Alejandro Castro Ruz*

b3  
b7E

File No.

[Redacted]

b3  
b7E

Date Received 4-12-56

From Havana Club

(Name of Contributor)

see entry SA

delivered 3/27/56 at Havana

(Address of Contributor)

b6  
b7C

By

(Name of Special Agent)

To Be Returned

Yes ( )

No (✓)

Description:

photo of Manuel Marquez  
Rodriguez



MANUEL MARQUEZ RODRIGUEZ  
(Dec 29, 1953)



b3

b7E

File No.

[Redacted]

b3  
b7E

Date Received

4/15/59

From

Bureau

(Name of Contributor)

W.D.C.

(Address of Contributor)

By

Sa.

[Redacted]

(Agent)

b6  
b7C

To Be Returned

Yes ( )

No (✓)

Description:

2 photos of

[Redacted]

[Redacted]

b6  
b7C



b6

b7C

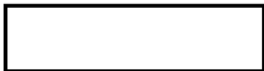

b3

b7E



File No.

[Redacted]

b3  
b7E

Date Received

*4/15/59*

From

*Bureau*

(Name of Contributor)

*W. D. C.*

(Address of Contributor)

By

*S.A.*

[Redacted]

(Agent)

b6  
b7C

To Be Returned

Yes ( )  
No ( )

Description:

*2 photos of*

[Redacted]

[Redacted]

b6  
b7C

b6  
b7C



b3  
b7E

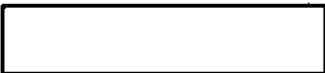

File No. \_\_\_\_\_

b3  
b7E

Date Received 4/17/59

From New York Office

(Name of Contributor)

N.Y.

(Address of Contributor)

By SA - \_\_\_\_\_

(Agent)

b6  
b7C

To Be Returned

Yes ( )

No (X)

Description:

*Photostats of letter  
and envelope address  
to*

*from*

b6  
b7C

AFTER FIVE DAYS. RETURN TO



●●● VIA AIR MAIL

b6  
b7C

[redacted]

[redacted]

4/6/59

[redacted]

yo si ordena  
ria no tres pesos asta cien  
por la cabeza de ese  
Carniseros y Comunistas y  
Criminal Costo. Parises.  
mentira que un diario tan  
cultura y tan social y  
democratico mensione el nombre  
de un herode y traidor.

Alto

[redacted]

yo me alegro que Fidel Castro  
venga a estado unidos  
porque no va a salir de aqui  
y no matara mas gente en  
Cuba.

b3  
b6  
b7C  
b7E

b6  
b7C

DIRECTOR, FBI [redacted]

1/26/56

SAC, WFO [redacted]

FIDEL ALEJANDRO CASTRO RUZ, wa.  
Juan Manuel Marquez

[redacted]

Reference is made to the report of SA [redacted] dated 1/4/56, at Miami, Fla. which contains a lead for the WFO to check Central Office records, INS for pertinent information concerning "JUAN MANUEL MARQUEZ and associates of FIDEL CASTRO". The lead does not reflect who the associates of CASTRO are or about whom, besides MARQUEZ, the Miami Division wants INS information.

It appears to the WFO that Miami intended for the lead to read "JUAN MANUEL MARQUEZ, an associate of FIDEL CASTRO", and this office is checking INS files for the name of MARQUEZ only unless Miami indicates which other names should be checked.

It is noted that in checking INS files on Latin American names, some background information is necessary in order to identify the files with the person in whom this Bureau is interested. If Miami desires that additional names in referenced report be checked, it is suggested that some background information be obtained regarding them. P.

- 2 - Bureau
- 1 - Miami [redacted] (Info)(RM)
- 1 - WFO [redacted]

[redacted]

(4)

[redacted]

(P) [redacted]

[redacted]

Searched [redacted]  
 Serialized [redacted]  
 Indexed [redacted]  
 Filed [redacted]

[redacted]

b3  
b7E

b6  
b7C

b3  
b6  
b7C  
b7E

b3  
b6  
b7C  
b7E

Date: 2/2/56

To: DIRECTOR, FBI [redacted]  
 From: SAC, NEW YORK [redacted]  
 Subject: FIDEL ALLJANDRO/CASTRO ROE, was;  
 JUAN MANUEL MARQUEZ

b3  
b7E

OO: NY

Relet to Assistant Attorney General [redacted]  
 from the Director dated 1/4/56.

b6  
b7C

On 12/20/55 [redacted] Assistant Attorney General, Internal Security Division, Department of Justice, advised the Director that subject, CASTRO, as chief of an organization known as the "26th of July Group", organized in Cuba, is under an obligation to register with the Attorney General under the terms of the Foreign Agents Registration Act. [redacted] requested that an address be supplied where a letter soliciting CASTRO's registration could be addressed to him.

b6  
b7C

CASTRO was the leader of the revolutionary attack on the Moncada Barracks at Santiago de Cuba on July 26, 1953. He was imprisoned by the Cuban authorities as a result of this, but in May, 1955, he was released under a General Amnesty Law. In July, 1955, he traveled to Mexico.

- 2 - Bureau [redacted] (Encs. 2) (RM)
- 2 - Albuquerque (Encs. 2) (RM)
- 2 - El Paso (Encs. 2) (RM)
- 2 - Houston (Encs. 2) (RM)
- 2 - Los Angeles (Encs. 2) (RM)
- 2 - Miami [redacted] (Encs. 2) (RM)
- 2 - Mobile (Encs. 2) (RM)
- 2 - New Orleans (Encs. 2) (RM)
- 2 - Phoenix (Encs. 2) (RM)
- 2 - San Antonio (Encs. 2) (RM)
- 2 - San Diego (Encs. 2) (RM)
- 2 - Washington Field (Encs. 2) (RM)
- 1 - New York [redacted]

b3  
b6  
b7C  
b7E

(25)

[redacted]

SEARCHED [redacted] INDEXED [redacted]  
 SERIALIZED [redacted] FILED [redacted]

FEB 7 1956  
 FBI - WASHINGTON

b3  
b6  
b7C  
b7E

handle pronto

Letter to Director  
[REDACTED]

b3  
b7E

On October 20, 1955, he entered the US at San Antonio, Texas. CASTRO subsequently addressed meetings of Cuban emigrants in NY and at Miami, Florida, and vicinity, where he advocated the violent overthrow of the government of President FULGENCIO BATISTA of Cuba and solicited funds for this purpose. In each community which he visited he attempted to organize a group using the name "Patriotic Clubs of July 26", "July 26th Club of New York", or similar titles. CASTRO departed from Miami, Florida, on December 10, 1955, by Guest Airlines destined for Mexico City.

The WFO is requested to place stop notices with the Customs Service and the Immigration and Naturalization Service at Washington, D. C., so that the Bureau will be notified immediately if CASTRO attempts to enter the US again. No process is outstanding for CASTRO for any violation within the jurisdiction of the FBI, and it is not desired that he be detained in any manner or made aware that the FBI is interested in him.

All offices receiving copies of this letter are requested to immediately notify the Bureau and the NYO by teletype if any information is received indicating CASTRO has entered the US. With the exception of obtaining all available information from the reporting agency relative to CASTRO's itinerary and destination in the US, no further action should be taken.

A description of CASTRO follows:

Name	FIDEL ALEJANDRO CASTRO RUZ wa; Fidel Castro Ruz
Height	6 feet
Hair	Brown
Eyes	Brown
Race	White
Complexion	Fair
Nationality	Cuban
Marital status	Divorced



Letter to Director  
[redacted]

b3  
b7E

Date of birth	August 13, 1926
Place of birth	Cueto, Oriente, Cuba
Occupation	Lawyer
Residences	Calle 23 #1511 or #1352-33 Havana, Cuba Hotel Tivoli Mexico City, Mexico [redacted] [redacted]

b6  
b7C

Cuban Passport No. 17702 issued at Havana,  
Cuba, 6/23/55

Two copies of a photograph/are <sup>of CASTRO</sup> enclosed for the Bureau and all offices receiving copies of this letter. This photograph was obtained from the front page of a booklet entitled, "La Historia Me Absolvera", which was reportedly written by CASTRO and printed on October 30, 1955.



UNITED STATES DEPARTMENT OF JUSTICE  
FEDERAL BUREAU OF INVESTIGATION

WASHINGTON 25, D. C.

In Reply, Please Refer to  
File No.

February 20, 1956

TO: ALL COLLECTORS OF CUSTOMS  
SUBJECT: FIDEL ALEJANDRO CASTRO RUZ, with alias Fidel Castro

The Federal Bureau of Investigation, U. S. Department of Justice, is interested in FIDEL ALEJANDRO CASTRO RUZ, a Cuban citizen who may attempt to enter the United States. FIDEL ALEJANDRO CASTRO RUZ is believed to presently reside at Calle 23 #1511 or 1352-33, Havana, Cuba, and is described as follows:

Born: 8/13/26, Cueto, Oriente, Cuba  
Race: White  
Height: 6'  
Eyes: Brown  
Complexion: Fair  
Hair: Brown  
Occupation: Lawyer  
Marital Status: Divorced

FIDEL ALEJANDRO CASTRO RUZ was issued Passport Number 17702 on June 23, 1955, at Havana, Cuba. He has also resided at Tivoli Hotel, Mexico City, Mexico, and with [redacted]

b6  
b7c

In the event this individual attempts to enter a port in your district, it would be appreciated if you would notify by telephone, collect if necessary, the nearest office of the Federal Bureau of Investigation, and at the same time advise that office that the New York Division of the Federal Bureau of Investigation is particularly interested in CASTRO.

In no event should this individual be detained or otherwise made aware that the Federal Bureau of Investigation is interested in him.

Very truly yours,

L. L. LAUGHLIN  
Special Agent in Charge

b3  
b6  
b7c  
b7E

Searched \_\_\_\_\_  
Serialized \_\_\_\_\_  
Indexed \_\_\_\_\_  
Filed \_\_\_\_\_

[redacted]

1cc - New York  
1cc - Customs

Sent to all Collectors of Customs  
2-20-56

Washington Field Office, Room 506  
Old Post Office Building

b3  
b7E

February 15, 1956

Washington 25, D. C.

[Redacted]  
Acting Assistant Commissioner  
Inspections and Examinations Division  
Immigration and Naturalization Service  
U. S. Department of Justice  
Washington 25, D. C.

b6  
b7C

Attention: Control Section

Re: Fidel Alejandro Castro Ruz, with  
alias, Fidel Castro

Dear Sir:

It is respectfully requested that a lookout  
notice be placed in your file and at all ports of entry  
on Fidel Alejandro Castro Ruz, with alias Fidel Castro.  
He is described as follows:

Date of Birth:	August 13, 1926
Place of Birth:	Cueto, Oriente, Cuba
Height:	6'
Hair:	Brown
Eyes:	Brown
Race:	White
Complexion:	Fair
Nationality:	Cuban
Occupation:	Lawyer
Residences:	Calle 23 #1511 or 1352-33, Havana, Cuba; Hotel Tivoli, Mexico City, Mexico;

b6  
b7C

Passport:

[Redacted]  
Cuban Passport #17702 issued at  
Havana, Cuba, 6/23/55

2-INS  
1-New York [Redacted] (Info) (RM) (When this lookout and/or stop  
notice has served its purpose, it should be withdrawn by  
your office directly by letter to INS. No stop card is  
maintained in WFO files.)

b3  
b6  
b7C  
b7E

②-WFO  
(1-66-1922)  
[Redacted] [Redacted] [Redacted]  
(5)

Searched [Redacted]  
Serialized [Redacted]  
Indexed [Redacted]  
Filed [Redacted]

[Redacted] [Redacted]

In the event that this individual attempts to enter or depart from a port in your district, it would be appreciated if you would notify by telephone, collect if necessary, the nearest office of the Federal Bureau of Investigation, and at the same time advise that office that the New York Division of the Federal Bureau of Investigation is particularly interested in Castro.

Castro should not be detained or otherwise made aware that the Federal Bureau of Investigation is interested in him.

Your cooperation is very much appreciated.

Very truly yours,

L. L. LAUGHLIN  
Special Agent in Charge

DIRECTOR, FBI [redacted]

2/15/56

SAC, WFO [redacted]

b3  
b7E

FIDEL ALEJANDRO CASTRO RUZ, wa., et al

[redacted]

(OO: NEW YORK)

ReNYlet 2/3/56 requesting stop notices be placed with INS and Customs.

The requested stop notices were placed with All Collectors of Customs and with the Central Office of INS for all ports of entry by letter dated 2/15/56.

The New York Division will advise the WFO when it is desired that these stop notices be removed. P.

2-Bureau

2-New York [redacted] (RM)

①-WFO

b3  
b6  
b7C  
b7E

[redacted]  
[redacted]  
(5) [redacted]

[redacted]

✓ [redacted]

[redacted]

b3  
b6  
b7C  
b7E

Searched \_\_\_\_\_  
Serialized [redacted]  
Indexed \_\_\_\_\_  
Filed [redacted]

~~CONFIDENTIAL~~

b6  
b7C

FD-72  
(6-10-53)

# FEDERAL BUREAU OF INVESTIGATION

FORM No. 1  
THIS CASE ORIGINATED AT **BUREAU**

REPORT MADE AT <b>MEXICO, D. F.</b>	DATE WHEN MADE <b>2/10/56</b>	PERIOD FOR WHICH MADE <b>12/7,16,23/55 1/18,23/56</b>	REPORT MADE BY [redacted]
TITLE <b>FIDEL ALEJANDRO CASTRO RUZ, wa. Fidel Castro Ruz; JUAN MANUEL MARQUEZ</b>		CHARACTER OF CASE [redacted]	

b3  
b6  
b7C  
b7E

### SYNOPSIS OF FACTS:

Subject FIDEL ALEJANDRO CASTRO RUZ reportedly resides in Mexico City at unknown address, but takes meals and makes contacts at [redacted] [redacted] which is the residence of [redacted]. In December, 1955, he published a "Manifiesto No. 2" in the name of the "National Directorate of the July 26 Revolutionary Movement" which allegedly was being sent to Cuba for printing and dissemination. Unconfirmed information received that he was joined recently in Mexico City by his colleague, JUAN MANUEL MARQUEZ. Subject reported [redacted]

b6  
b7C

b7D

-P-

APPROVED AND FORWARDED: [redacted]	SPECIAL AGENT IN CHARGE [redacted]	DO NOT WRITE IN THESE SPACES	
COPIES OF THIS REPORT 14 - Bureau [redacted] 1 - American Embassy [redacted] (circulation) 1 - Mexico City [redacted]		SEARCHED [redacted] INDEXED [redacted] SERIALIZED [redacted] FILED [redacted] <b>MAR 13 1956</b> FBI - WASHINGTON	[Handwritten initials]

b3  
b6  
b7C  
b7E

PROPERTY OF FBI—This ~~confidential~~ report and its contents are loaned to you by the FBI and are not to be distributed outside of agency to which loaned.

UNITED STATES DEPARTMENT OF JUSTICE  
FEDERAL BUREAU OF INVESTIGATION

In Reply, Please Refer to  
File No.

Washington 25, D. C.

February 10, 1956

~~CONFIDENTIAL~~

RE: FIDEL ALEJANDRO CASTRO RUZ,  
wa. Fidel Castro Ruz;  
JUAN MANUEL MARQUEZ

I. BACKGROUND DATA -  
FIDEL ALEJANDRO CASTRO RUZ

A. Residence

T-1, who has furnished reliable information in the past, advised that FIDEL ALEJANDRO CASTRO RUZ was in Mexico City as of the middle of December, 1955, and had been seen in Mexico City from time to time thereafter up to and including February 3, 1956. T-1 was unable to furnish subject's residence address in Mexico City, but stated he has been taking most of his meals and making contacts at [redacted]

[redacted] T-1 stated [redacted]

b6  
b7C  
b7D

[redacted] T-1

B. Employment

T-1 advised that the subject is not employed in Mexico, but that he is spending his entire time in connection with his efforts to organize a revolutionary movement against the present Cuban Government.

T-2, who has furnished reliable information in the past, advised that [redacted]

b7D

C. Information [redacted]

T-2 advised that the following information concerning subject [redacted]

b7D

~~CONFIDENTIAL~~

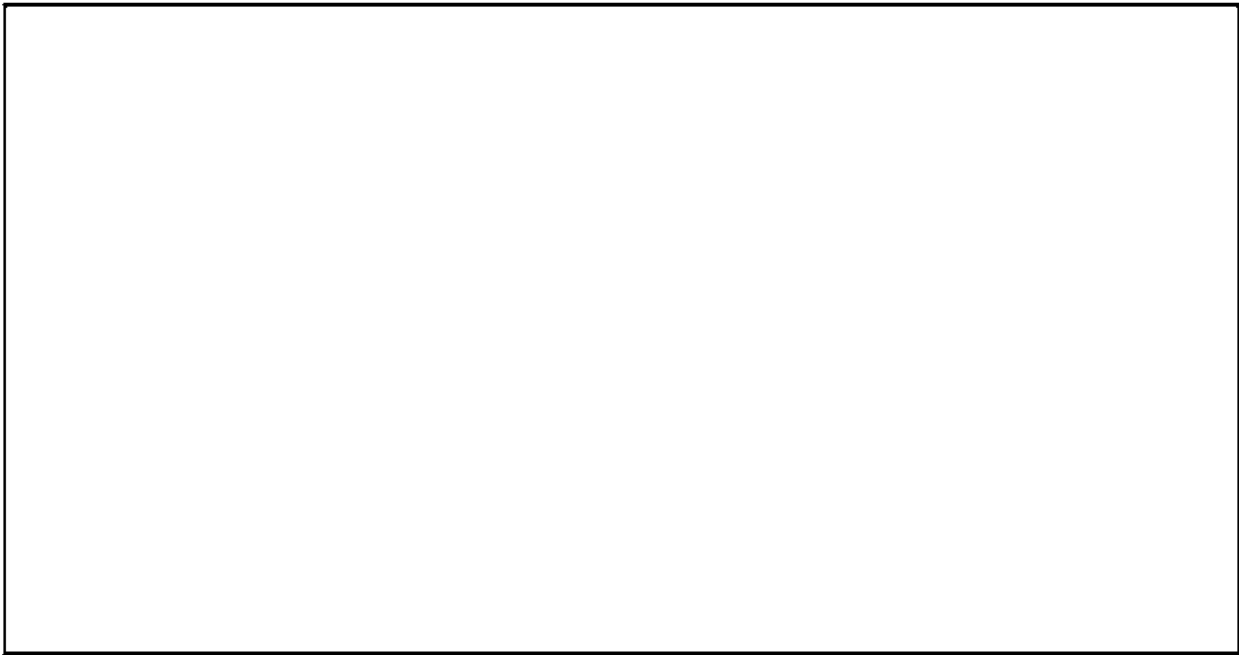

b6  
b7C  
b7D

II. ACTIVITIES -  
FIDEL ALEJANDRO CASTRO RUZ



b7D

B. Revolutionary Activities

T-1 advised that

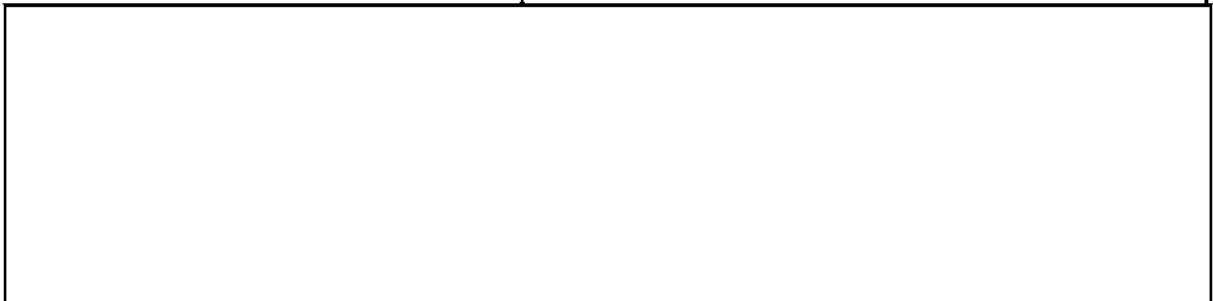
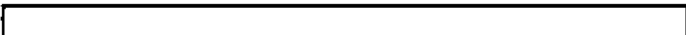

b7D

This pamphlet was entitled "Manifiesto No. 2 of the July 26 (group) to the People of Cuba" and was signed by



FIDEL CASTRO "in the name of the National Directorate of the July 26 Revolutionary Movement." The leaflet also stated it was "signed on the island of Nassau on December 10, 1955," but, according to T-1, [REDACTED]

b7D

C. Translation of Manifiesto

There follows hereinunder a translation from Spanish of the "Manifiesto No. 2" described above:

"IN ALL HONORABLE HEARTS WE SHALL FIND MAGNANIMOUS SUPPORT. AND WE SHALL KNOCK AT ALL DOORS. AND WE SHALL SOLICIT CONTRIBUTIONS FROM TOWN TO TOWN. AND THEY WILL BE GIVEN TO US BECAUSE WE SHALL ASK WITH HONOR."

JOSE MARTI

I direct these lines fundamentally to the generous men and women of my country. In my mind's eye I can still see the unforgettable scenes which I have experienced among the Cuban immigration in the United States. Standing with their hands raised those Cubans, wherever we went, swore that they would not rest until their land was redeemed, and they came forward en masse to deposit in the straw hat the product of their sweat which here is spent in hard work. But that was not to be their only contribution. It is not necessary to seek out the Cuban emigrants requesting their aid; following each public meeting they are seen in the streets asking the location of the PATRIOTIC CLUB in order to petition their registration and offer their weekly contribution; every Sunday they will organize Cuban festivities in order to deliver everything that is collected for the revolution: the first of those, which took place a few days ago in New York, gave a balance of hundreds of pesos. All of the beautiful of our historic tradition has been born again in the Cuban emigration with indescribable fervor. The PATRIOTIC CLUBS of Bridgeport, Union City, New York, Miami, Tampa, and Key West are organized. New nuclei will be organized in Chicago, Philadelphia, Washington, and other places where Cubans reside who have had to abandon their native land. Seven weeks of untiring effort, dedicated to the organization of Cubans, from the Canadian frontier to the glorious Keys, have rendered the best possible fruits.

The JULY 26, which unites and organizes all of the revolutionary elements of the country in a tightly knit and disciplined movement, departing from the traditional borders in which thus far the miserable Cuban politics have operated, has called to the struggle on an equal basis our brothers of the emigration who also are Cubans who suffer the misfortunes of Cuba, and the emigration has responded unanimously in connection with the JULY 26. The emigration offers hundreds of young combatants, many of them veterans of the European and Pacific fronts of the second world war, who now wish to fight for the cause of liberty in their own land and besides offer abundant economic resources in order that those generous and virile arms will not go unarmed in confronting tyranny again with the cry of liberty or death on their lips.

Some do not fully understand the meaning of the public pronouncement of a revolutionary idea and they ask if that does not place the oppression on guard. They forget many things; but in the first place they forget we are not millionaire embezzlers with huge sums deposited in the banks; they forget that we are not rich and do not have private resources which we can place at the disposition of our cause, but which we would offer without vacillation if we had them, just as we offer the only thing we possess: our energy and our lives; they forget that a revolution is different from a military Putsch, it is the work of the people and it is necessary that the people be advised in order that they may know what is to be their part in the fight. In a revolution, as Marti said: "The methods are secret and the goals are public." Does anyone think perchance that when our liberators publicly were soliciting the assistance of the tobacco merchants of Tampa and Key West, they pretended to hide from the Spanish authorities that a revolution was being plotted in Cuba? If we are not embezzlers, if we are not rich, how are we going to obtain the means indispensable for the fight if not by soliciting them from the people? And how are we going to request assistance from the people if we do not talk to the people and advise them as to why we want their assistance? If the revolution robs a bank in order to obtain funds, the enemy will say that the revolutionaries are gangsters; if the revolution accepts aid from the embezzlers who plundered the republic, the revolution will be betraying its principles; if the revolution solicits aid from the

large interests, the revolution will be compromised before it achieves power.

Already we have entered into combat with the scarce resources which we could obtain by each one giving what he had and soliciting in silence the aid of a few generous persons, and the result was defeat and the frightful crimes which followed; then we would have done nothing had we asked publicly because no one would have paid any attention; their faith was placed in other men from whom everything was expected in opposition to the oppression. To date, after we have had to pay such a high price in sacrifices and lives for the consideration of our compatriots, we will do what we could not do at that time: go publicly to the people for their aid; prepare the country for the revolution on a large scale without possibilities of failure; give instructions that on all sides the masses must follow, when the national rebellion explodes like a tempest in order that the combat groups, well-armed and well-led, and the youth groups of action and agitation can be supported by the workers of the entire country who shall be organized from below in revolutionary cells capable of beginning a general strike. What the enemy never will know is where the arms are located and in what moment the insurrection will break out. If the politician publicly promulgates his electoral thesis, the revolution should publicly preach its thesis of rebellion.

To openly preach the revolution will, without doubt, bring better fruits than to speak of peace in public and conspire in secret, which was the method used during three and one-half years by the group which was removed from power on March 10, their secret never being secret from anybody. Thanks to our campaign it is seen that despite the return of the exiled "Autenticos" (party of Prio Socarras), which many interpreted erroneously as the end of the insurrectional phase, the sentiment and agitation is stronger than ever in the entire nation and our cry of "Revolution!...Revolution!" is the motto of the masses wherever the people meet. All of the electoral plans of the regime to perpetuate itself in power with the complicity of the political gangs of the pseudo-opposition have been broken up by our strategy. Only the blind or the cheap or the envious or the weak can deny it.

The national panorama is becoming clearer; events at last are proving us to be right. The massacres of workers, the street fights between students and police, the growing economic crisis with its resulting hunger and misery, the uncontrolled increase in the public debt which for the next thirty years compromises the credit of the nation, the men who have disappeared without leaving any trace, the unpunished crimes, the daily embezzlements, and the haughty and rotund refusal which the dictator gave to the hundred thousand citizens who were congregated at the "MUELLE DE LUZ" (dock of light), demonstrate that there is no other recourse for the country than the revolution. Those who thus far have continued to support any other idea at the present time have only two alternatives: either they bow to the regime or they ally themselves with the revolution, the standard of which only we have held on high when everyone was running in search of an electoral arrangement with the dictatorship. Even the most humble citizen correctly interprets the situation in Cuba when he affirms that Batista and his gang of millionaire generals have mocked public opinion for the past four years and they will not abandon their positions unless they are removed from them by force. To the cowards who express the opinion that he has the tanks, the cannons, and the airplanes, the reply of a worthy nation, of a people who has pride, should be: "Well then let us too obtain the necessary arms; let us deliver to the combatants the economic resources which they lack; if with that which the tyranny collects from us by force in taxes she is able to buy her arms and pay her executioners, let us voluntarily help with our resources those who for the past four years have fought and died for our redemption; let us help them because the duty of sacrificing oneself for one's country is for all and not for a few; let us help them because the frivolous life, the indifferent life, in the presence of a country which is in agony is a crime when others are suffering imprisonment or exile or lie beneath the vilified earth..."

Let each citizen contribute a peso; let each worker deliver the equivalent of one day's salary, as the Cuban emigrants of January 28 are going to do and they will see how the tyranny will fall apart suddenly in less time than many imagine.

Those of us who lead an austere and poor life,

dedicated to the struggle without rest and without respite, giving to the country our youth and our lives, working for six million Cubans without collecting anything from anyone, feel within us the morale and courage to speak to the nation in these terms. To ask is bitter even when it is for one's country, but it is more bitter to live as we live, oppressed; for a husband to see how an insolent person in uniform offends his wife; for a mother to see how they drag from her home a son or a husband in the middle of the night; for a man who is the father of a family to see how despite his years and his health they strike him and abuse him without any respect whatsoever in some police station; for the merchant to see how they take from him a package of tobacco or a pound of meat or a cup of coffee, the very agent who should protect him from the evildoers, and if not they fine him or accuse him unjustly of some violation; to see the barefoot child begging alms in the streets; to see the men with their arms folded on the corners; to see the lines before a foreign consulate soliciting visas to leave the country; to see, in summary, the innumerable injustices which occur daily within our view.

Let the people who see us suffer, who see us agonizing, who see us fighting, who see us asking alms for our country, give heed.

Others ask for themselves and place in security a house, a farm, jewelry, or any other property; we ask for Cuba and we place in security our lives; each peso which is deposited in our hands is a check which is issued against the existence of the men who have promised to die before giving up the undertaking in which they are engaged. And those who from egotism or miserliness refuse to help them will see them die with tremendous remorse of conscience, knowing that they are right and they fight for a just cause, for a noble ideal, for a worthy principle, for a common good.

We know that this call will not fall in a vacuum; already on one occasion when the newspaper "La Calle" was going to close for lack of resources we made a similar appeal and the people immediately began to help it in a splendid fashion. The regime had to close it. This time we are not asking for a newspaper; we are asking for the entire country; we are asking in order to purchase

the freedom of six million slaves; we are asking to serve a nation; the contributions, therefore, should be a thousand times more generous and more spontaneous.

The collection of funds on the part of a movement which operates clandestinely is a difficult task, but is perfectly operable in this case because of the organization and discipline of our groups scattered throughout the island.

It is imperative, nevertheless, that the following norms be followed:

No citizen should deliver anything to anyone in whom he does not have absolute confidence as to his honesty, seriousness, and moral prestige and the certainty that through him the donation will arrive at the Treasury of the Movement.

No one will have a carnet or any identification in this movement for the specific purpose of collecting funds, and the only valid credential of one of our militants for that purpose will be the prestige which he enjoys in the place where he is established or he exercises his profession.

No one should deliver a single cent to any person from another locality or from another work center or alleged place of employment in order that no unknown person can present himself in any locality as a member of the July 26 Movement for the purpose of collecting funds.

No one will be given a receipt or bond as evidence of his contribution since any document of this type would be compromising, not only for the one who delivers it, but also for the person receiving it. In due time, when the present circumstances of oppression have disappeared, honor lists will be formed with the names of the persons who have contributed as taken from the testimony of the members of our economic sections.

The dictatorship will be unable to take effective measures against this economic campaign because it is faced with a type of mass conspiracy.

Any impostor, who passes himself off as a member

~~CONFIDENTIAL~~

of our movement and attempts to collect funds in its name, will be discovered without delay by our militants who are alert and are everywhere and they shall make certain that he is given his proper punishment, as occurred in the Province of Matanzas to a rogue named Ramon Estevez, who was dedicating himself to that vile task, utilizing a false credential with our photograph superimposed thereon. There is no more effective vigilance than the collective vigilance.

All forms of collection by means of force or violence are completely foreign to our procedures.

The above-named norms of collection will be applied in national territory where our organization functions clandestinely but not in connection with the emigration where the patriotic clubs carry out their tasks under conditions of legality.

The Treasury of the Movement will maintain a minute record of income and expenditures concerning which it will make a complete account to the nation when its work has been concluded.

In name of the National Directorate of the  
JULY 26 REVOLUTIONARY MOVEMENT, signed on the island of  
Nassau, December 10, 1955.

FIDEL CASTRO

III. INFORMATION CONCERNING  
JUAN MANUEL MARQUEZ

T-1 advised in the latter part of January, 1956, that  
JUAN MANUEL MARQUEZ had joined FIDEL CASTRO in Mexico City and

T-1 was unable to furnish any background data concerning  
MARQUEZ, but expressed the belief that for many years he was a  
youth leader in the Cuban "Ortodoxo" political party and that  
he had been with FIDEL CASTRO at the time of the July 26, 1953,  
attack on the Moncada Hospital Barracks at Santiago de Cuba.

~~CONFIDENTIAL~~

ADMINISTRATIVE PAGE

Extra copies of this report are being provided for the Bureau for possible dissemination to the New York, Washington Field, and Miami [redacted] Offices. A copy hereof has been disseminated on a circulation basis to the Political Section of the American Embassy [redacted]

b3  
b7E

In accordance with Bureau instructions, a stop has been placed with the Visa Section of the U. S. Embassy in the event either subject applies for a visa for entry into the United States. Personnel of the Embassy Visa Section have advised that they wish to communicate with FIDEL CASTRO on the basis of instruction from the Department of State, but it has not been deemed advisable to furnish subject's address at Calle Amparen #49 to them in view of the danger that to do so would compromise the principal source of information concerning this case.

Careful consideration has been given to each source concealed in this report, and T symbols have been utilized only where the identities of the sources must be concealed.

<u>Identity of Source</u>	<u>Date of Activity and/or Description of Information</u>	<u>Date Received</u>	<u>Agent to Whom Furnished</u>	<u>File No. Where Located</u>
T-1 [redacted]	Residence and employment	1/18/56 2/3/56	SA [redacted] [redacted] (orally)	Instant report
	Revolutionary activities	1/18/56	SA [redacted] [redacted] (orally)	Instant report
	Manifiesto	1/18/56	SA [redacted] [redacted] (orally)	Instant report
	Arrival of JUAN MANUEL MARQUEZ to Mexico	1/18/56	SA [redacted] [redacted] (orally)	Instant report

b6  
b7C  
b7D

[redacted] and who has furnished reliable information insofar as it has been possible to check same.



ADMINISTRATIVE PAGE

<u>Identity of Source</u>	<u>Date of Activity and/or Description of Information</u>	<u>Date Received</u>	<u>Agent to Whom Furnished</u>	<u>File No. Where Located</u>
T-2 [redacted]	[redacted]	12/23/55	SA [redacted] [redacted]	[redacted]
		11/30/55	SA [redacted] [redacted]	[redacted]

b6  
b7C  
b7D

LEAD

MEXICO CITY

AT MEXICO, D. F., MEXICO:

1. Will continue efforts to locate residence of subjects and to further identify JUAN MANUEL MARQUEZ.
2. Will continue to follow and report subjects' status and activities in Mexico.

REFERENCES

Mexico City airgram to Bureau dated 1/18/56.  
Bureau letter to Assistant Attorney General [redacted]  
dated 1/4/56.

b6  
b7C

SAC, New York [redacted]

March 12, 1956

Director, FBI [redacted]

b3  
b7E

FIDEL ALFONSO CASTRO RIZ, wa;  
JUAN MANUEL MARQUEZ

[redacted]

For the information of the New Haven, Chicago, and Philadelphia Offices, which have not received any previous correspondence in this matter, Castro was the leader of a revolutionary attack on the Moncada Army Barracks at Santiago, Cuba, on 7-26-53. He was imprisoned by Cuban authorities as a result of this activity, but in May, 1955, he was released under a general amnesty law. During July, 1955, Castro and Marquez, who had also taken part in the attack on the Moncada Army Barracks, travelled to Mexico and during October, 1955, they entered the U.S. at San Antonio, Texas. The subjects subsequently addressed meetings of Cuban emigrants at New York City and Miami, Florida, and vicinity, during the course of which they advocated the violent overthrow of the present Cuban Government headed by President Fulgencio Batista and solicited funds for this purpose. The subjects also attempted to organize various groups, using the name "Patriotic Clubs of July 26," "July 26 Club of New York" and similar titles. The subjects departed from the U.S. at Miami, Florida, on 12-10-55 for Mexico and are presently residing in Mexico City. The Internal Security Division of the Department has advised that the subjects are under an obligation to register with the Attorney General under terms of the Registration Act in the event they should return to this country.

Enclosure

b3  
b6  
b7C  
b7E

cc - 2 - Miami [redacted] (enclosure)

cc - 2 - Washington Field [redacted] enclosure

cc - 2 - Newark [redacted] (enclosure)

cc - 2 - New Haven (enclosure)

cc - 2 - Chicago (enclosure)

cc - 2 - Philadelphia (enclosure)

SEARCHED	INDEXED
SERIALIZED	FILED
MAR 13 1956	
FBI - WASHINGTON	

Letter to SAC, New York

There is enclosed herewith for each office receiving a copy of this letter one copy of the report of SA [redacted] dated 2-10-56 at Mexico City. Attention is directed to page 3, paragraph C., of this report, which sets forth a translation of a "Manifesto" issued by Castro under date of 12-10-55. According to this document, "Patriotic Clubs" have been organized at Bridgeport, Union City, New York, Miami, Tampa, and Key West and "new nuclei" will be organized in Chicago, Philadelphia, and Washington.

b6  
b7c

The New York and Miami Offices have previously been instructed to institute appropriate investigation concerning any such groups organized by the subjects in their territories. The New Haven and Newark Offices are instructed to contact established sources and conduct other appropriate investigation to determine whether similar groups have been organized at Bridgeport, Connecticut, and Union City, New Jersey. [redacted]

b3  
b7E

[redacted] The Chicago, Philadelphia, and Washington Field Offices should alert their established sources so as to be promptly advised in the event similar groups are founded in these cities.

# FEDERAL BUREAU OF INVESTIGATION

~~CONFIDENTIAL~~

FORM No. 1  
THIS CASE ORIGINATED AT **NEW YORK**

b3  
b6  
b7C  
b7E

REPORT MADE AT <b>WASHINGTON, D. C.</b>	DATE WHEN MADE <b>APR 10 1956</b>	PERIOD FOR WHICH MADE <b>1/23; 2/10, 15; 3/15/56</b>	REPORT MADE BY [redacted]
TITLE <b>FIDEL ALEJANDRO CASTRO RUZ, wa.; JUAN MANUEL MARQUEZ</b>			CHARACTER OF CASE [redacted]

### SYNOPSIS OF FACTS:

INS files reflect one JUAN MANUEL MARQUEZ Y RODRIGUEZ, 141 West 75th Street, New York City, admitted to U. S. at San Antonio, Texas, 10/20/55. Admitted to 11/5/55.

- RUC ✓ [redacted]

DETAILS: AT WASHINGTON, D. C.

SE [redacted] caused a search to be made of the files of the Central Office of the United States Immigration and Naturalization Service (INS) and was advised on March 15, 1956, that these files reflect the following information regarding one JUAN MANUEL MARQUEZ Y RODRIGUEZ:

Birth date:	July 5, 1915
Birthplace:	Punta Brava, Cuba
Home address:	141 West 75th Street, New York City
Address in United States:	Transit
Hair:	Brown
Eyes:	Green
Height:	5 feet 3 inches

b6  
b7C  
  
b6  
b7C

APPROVED AND FORWARDED: [redacted]	SPECIAL AGENT IN CHARGE [redacted]	DO NOT WRITE IN THESE SPACES
COPIES OF THIS REPORT		Searched [redacted] Serialized [redacted] Indexed [redacted] Filed [redacted]
8 - Bureau [redacted] 3 - New York [redacted] (RM) 1 - Miami [redacted] (Info) (RM) ① - Washington Field [redacted]		

b3  
b6  
b7C  
b7E

PROPERTY OF FBI--This report is loaned to you by the FBI, and neither it nor its contents are to be distributed outside the agency to which loaned.

~~CONFIDENTIAL~~

~~CONFIDENTIAL~~

b3  
b7E

[REDACTED]

Weight: 165 pounds  
Nationality: Cuban  
Race: White  
Occupation: Constructor  
Passport: Cuban passport No. 18684 dated August 7, 1953.

MARQUEZ entered the United States at San Antonio, Texas, on October 20, 1955, and was admitted to November 5, 1955. He previously entered the United States on September 9, 1955. It was noted MARQUEZ was in transit when admitted to the United States on October 20, 1955. His nearest relative was noted to be Mrs. MARQUEZ, residing at 141 West 75th Street, New York City.

SA [REDACTED] caused a search to be made of the files of the Office of Security, United States Department of State, and was advised on February 15, 1956, that no record of subject was found in the Visa Office and that the files of the Office of Security contained no additional information.

b6  
b7C

- RUC -

~~CONFIDENTIAL~~

[REDACTED]

b3  
b7E

ADMINISTRATIVE DATA

Eight copies of this report are being furnished the Bureau because eight copies of referenced report were furnished the Bureau.

LEADS

MIAMI DIVISION: (INFORMATION)

One copy of this report is being furnished the Miami Division as Miami is a port of entry and will probably have other leads in this case.

REFERENCES

Report of SA [REDACTED] dated 1/4/56 at Miami, Florida.  
WFO letter to the Bureau dated 1/26/56.

b6  
b7C

ADMINISTRATIVE PAGE

# FEDERAL BUREAU OF INVESTIGATION

FD-72  
(3-9-54)

FORM NO. 1

THIS CASE ORIGINATED AT

BUREAU

REPORT MADE AT <b>NEW HAVEN</b>	DATE WHEN MADE <b>4/20/56</b>	PERIOD FOR WHICH MADE <b>3/19, 27; 4/12, 13, 17/56</b>	REPORT MADE BY SA <span style="border: 1px solid black; display: inline-block; width: 100px; height: 15px;"></span>
TITLE <b>FIDEL ALEJANDRO CASTRO RUZ, wa., Fidel Castro Ruz; JUAN MANUEL MARQUEZ</b>			CHARACTER OF CASE <div style="border: 1px solid black; width: 100%; height: 40px;"></div>

b3  
b6  
b7C  
b7E

**SYNOPSIS OF FACTS:**

Persons contacted advised never heard of subjects and have not heard of any club composed of Cubans in Bridgeport similar to "Patriotic Club of July 26". These persons noted "Licoo-Cubano de Bridgeport", recreational club, only Cuban club in Bridgeport to their knowledge.

RUC

**DETAILS: AT BRIDGEPORT, CONNECTICUT**

On March 27, 1956, T-1, who has furnished reliable information in the past, and who is familiar with certain phases of the activities of the Spanish speaking people in Bridgeport, Connecticut, advised that he has never heard of captioned subjects or of a Cuban club known as the "Patriotic Club of July 26", or any club with a similar name. T-1 stated that the local Cubans have a club known as "Licoo-Cubano de Bridgeport", but according to T-1, this club has been in existence for many years and is a recreational club. T-1 related that he would contact his Cuban sources and attempt to determine if such a club had been established in Bridgeport, Connecticut.

APPROVED AND FORWARDED  SPECIAL AGENT IN CHARGE	DO NOT WRITE IN THESE SPACES
COPIES OF THIS REPORT 6-Bureau 1-Miami (Info.) 1-INFO (Info.) 1-Newark (Info.) 1-Chicago (Info.) 1-Philadelphia (Info.) (cont. P2)	<div style="border: 1px solid black; width: 100%; height: 20px;"></div> <div style="display: flex; justify-content: space-around;"> <span>SEARCHED</span> <span>INDEXED</span> </div> <div style="display: flex; justify-content: space-around;"> <span>SERIALIZED</span> <span>FILED</span> </div> <div style="text-align: center; margin-top: 5px;"> <b>MAY 2 - 1956</b>              FBI - WASHINGTON         </div>

b3  
b6  
b7C  
b7E

**PROPERTY OF FBI—This report is loaned to you by the FBI, and neither it nor its contents are to be distributed outside the agency to which loaned.**

[redacted]

On April 12, 1956, T-1 advised that he had contacted several Cuban sources and all advised that they were not familiar with the above-captioned subjects and had not heard of any Cuban club being formed in Bridgeport with a name similar to "Patriotic Club of July 26".

On the dates indicated, the following individuals, who advised that they are familiar with certain phases of the activities of Spanish speaking people in the Bridgeport, Connecticut area were contacted and all advised that they had never heard of the subjects, and knew of no club in the Bridgeport, Connecticut area with a name similar to "Patriotic Club of July 26". All advised that the only Cuban Club with which they were familiar in the Bridgeport area was a recreational club known as "Liceo-Cubano de Bridgeport."

[redacted]

(contacted on 4/13/56)

[redacted]

(contacted on 4/13/56)

[redacted]

(contacted on 4/17/56)

b6  
b7C  
b7D

RUC

Copies continued

1-New Haven [redacted]

b3  
b7E



[Redacted]

b3  
b7E

Extra copies of this report are being furnished to the Bureau inasmuch as the Bureau may desire to disseminate copies to Mexico City.

Information copies are being forwarded to Miami, Washington Field Office, Newark, Chicago, and Philadelphia, in view of the interest of those offices in this matter.

It is noted that [Redacted] mentioned in the details of this report, are sources of information of the New Haven Office. All persons contacted related they would advise the New Haven Office if any information concerning such a club should come to their attention.

b6  
b7C  
b7D

Identity of Source	Date, Activity	Date Received	Agent	File
T-1. PCI [Redacted]	Negative	3/27/56	SA [Redacted] [Redacted]	Instant Report
	" "	4/12/56	" "	" "

b6  
b7C  
b7D

REFERENCE: Bureau letter to New York dated 3/12/56.  
Report of SA [Redacted] dated 2/10/56  
at Mexico, D.F.

b6  
b7C

ADMINISTRATIVE PAGE

TO: SAC, Washington Field

For information

XX

b3  
b7E

For appropriate action

SEARCHED \_\_\_\_\_ INDEXED \_\_\_\_\_  
 SERIALIZED \_\_\_\_\_ FILED \_\_\_\_\_  
 APR 12 1956  
 FBI - WASHINGTON

b3  
b6  
b7C  
b7E

~~CONFIDENTIAL~~

b6  
b7C

# FEDERAL BUREAU OF INVESTIGATION

Form No. 1  
THIS CASE ORIGINATED AT **BUREAU**

REPORT MADE AT <b>HAVANA, CUBA</b>	DATE WHEN MADE <b>3/27/56</b>	PERIOD FOR WHICH MADE <b>3/20,23/56</b>	REPORT MADE BY [ ]
TITLE <b>CHANGED FIDEL ALEJANDRO CASTRO RUIZ, wa. Fidel Castro Rusy JUAN MANUEL MARQUEZ RODRIGUEZ</b>		CHARACTER OF CASE [ ]	

b3  
b6  
b7C  
b7E

SYNOPSIS OF FACTS:

*Juan Manuel Marquez  
Fidel Castro Rusy  
Fidel Castro Rusy*

Background and descriptive information is set out re JUAN MANUEL MARQUEZ, who is allegedly associated with FIDEL CASTRO in collecting money to buy arms for use in Cuban insurrectional movement. He is reported to be in Mexico at the present time. His exact activities and address are unknown.

- F -

The title of this case has been changed to show the full name of subject JUAN MANUEL MARQUEZ RODRIGUEZ, as furnished by T-1, a confidential source abroad.

C

APPROVED AND FORWARDED:	SPECIAL AGENT IN CHARGE	[ ]	ACES
COPIES OF THIS REPORT		SEARCHED [ ] INDEXED [ ]	[ ]
<b>12-Bureau</b> <b>2-Havana</b> [ ] (Encls.-3)		SERIALIZED [ ] FILED [ ]	
		APR 12 1956	
		FBI - WASHINGTON	

b3  
b6  
b7C  
b7E

~~CONFIDENTIAL~~

~~CONFIDENTIAL~~



United States Department of Justice  
Federal Bureau of Investigation

Washington, D. C.  
March 27, 1956

Re: FIDEL ALEJANDRO CASTRO RUIZ,  
wa. Fidel Castro Rus;  
JUAN MANUEL MARQUEZ RODRIGUEZ

T-1, a confidential source abroad, advised on March 20, 1956, that JUAN MANUEL MARQUEZ RODRIGUEZ, who is ordinarily known as JUAN MARQUEZ, is alleged to have been associated with FIDEL CASTRO while he was in the United States collecting money with which to buy arms for use in Cuban insurrectional movement. T-1 reported that MARQUEZ is believed to be in Mexico with CASTRO at the present time. However, his exact activities and address are unknown.

T-1 claims that MARQUEZ has a long history of insurrectional activity in Cuba, and that he was a Communist in the year 1933. According to T-1, he took part in the uprising at Santiago, Cuba on July 26, 1953, when raiders led by CASTRO attacked the Cuban Army fortress, "Cuartel Moncada."

According to T-1, [redacted]

b7D

T-1 states that [redacted]

b6  
b7C  
b7D

T-2, who has furnished reliable information in the past, advised [redacted]

b7D

[redacted] No additional information is available from T-2 concerning this matter.

- 1 -  
~~CONFIDENTIAL~~

~~CONFIDENTIAL~~

T-1 furnished the following

[Redacted]

[Large Redacted Area]

b7D

~~- 2 -~~

ADMINISTRATIVE

A copy of this report has been disseminated to [redacted]

b3  
b7E

Four extra copies are being submitted to the Bureau for possible dissemination to the New York [redacted] Washington Field, Miami [redacted] and Mexico City [redacted] Offices.

b3  
b7E

One negative and two prints of photograph of JUAN MANUEL MARQUEZ RODRIGUEZ, which were furnished by T-1, are enclosed in the event it is desired to forward them to Mexico City or to have extra copies made for other offices.

Careful consideration has been given to each source concealed in this report and T symbols have been utilized only where the identity of the sources must be concealed.

INFORMANTS

<u>Identity of Source</u>	<u>Date of Activity and/or Description of Information</u>	<u>Date Received</u>	<u>Agent to Whom Furnished</u>	<u>File Number Where Located</u>
T-1 [redacted]	Information re subject JUAN MANUEL MARQUEZ RODRIGUEZ	3/20/56	[redacted]	Instant Report
T-2 Confidential Informant [redacted] of the Havana Office	Information re subject JUAN MANUEL MARQUEZ RODRIGUEZ	Sept. 1945	[redacted]	[redacted]

b6  
b7C  
b7D

b3  
b6  
b7C  
b7D  
b7E

LEADS

HAVANA:

At Havana, Cuba

Will continue efforts to obtain information concerning present residence and activities of subject.

ADMINISTRATIVE PAGE

REFERENCE

Report of SA  dated February 10, 1956, at  
Mexico, D. F.

b6  
b7c

ADMINISTRATIVE PAGE

Legal Attache  
Havana, Cuba

[Redacted]

April 30, 1956

Director, FBI

[Redacted]

FIDEL ALJANDRO CASTRO RUIZ, was;  
JUAN MANUEL MARQUEZ

[Redacted]

b3  
b7E

Reurlet 3-27-56 forwarding a copy of the fingerprints of  
Juan Manuel Marquez Rodriguez

[Redacted]

b7D

These prints have been searched through the records  
of the Identification Division and it has been determined that Juan  
Manuel Marquez Rodriguez, FBI Number 232 150 C, was fingerprinted  
as an alien on 12-14-53, place and fingerprinting agency not shown.

The foregoing is for your information.

- cc - 1 - New York [Redacted] (Info)
- Miami [Redacted] (Info) ✓
- Washington Field [Redacted] (Info)
- Newark [Redacted] (Info)
- Mexico City (Info)

b3  
b7E

W

b3  
b6  
b7C  
b7E

[Redacted]

SEARCHED	INDEXED
SERIALIZED	FILED
APR 30 1956	
FBI - WASHINGTON	

[Redacted]



# FEDERAL BUREAU OF INVESTIGATION

FORM No. 1  
THIS CASE ORIGINATED AT

BUREAU

~~CONFIDENTIAL~~

C

REPORT MADE AT MEXICO, D. F.	DATE WHEN MADE OCT 2 1956	PERIOD FOR WHICH MADE 9/19,20/56	REPORT MADE BY [redacted]
TITLE FIDEL ALEJANDRO CASTRO RUZ, WA; JUAN MANUEL MARQUEZ		CHARACTER OF CASE [redacted]	

b3  
b6  
b7C  
b7E

**SYNOPSIS OF FACTS:**

Subject CASTRO and alleged associates arrested by agents of the Mexican National Security Police on 6/21/56 and thereafter and charged with "illegal political activity." Most of the group were released on 7/9/56, and CASTRO was released 7/21/56, allegedly on condition that he leave Mexico as soon as possible and abstain from political activity prior to his departure. As of 9/18/56 CASTRO reported to be still residing in Mexico City at Calle Panuco #221 and to be continuing his efforts to organize a revolutionary attack against the BATISTA government.

[redacted]

b7D

-P-

~~CONFIDENTIAL~~

APPROVED AND FORWARDED: [redacted]	SPECIAL AGENT IN CHARGE [redacted]	DO NOT WRITE IN THESE SPACES [redacted]
COPIES OF THIS REPORT 11 - Bureau [redacted] 1 - American Embassy [redacted] (circulation) 1 - Mexico City [redacted]		SEARCHED [redacted] INDEXED [redacted] SERIALIZED [redacted] FILED [redacted] OCT 23 1956 FBI WASHINGTON [redacted]

b3  
b6  
b7C  
b7E

PROPERTY OF FBI—This ~~confidential~~ report and its contents are loaned to you by the FBI and are not to be distributed outside of agency to which loaned.

[redacted]

UNITED STATES DEPARTMENT OF JUSTICE  
FEDERAL BUREAU OF INVESTIGATION

In Reply, Please Refer to  
File No.

Washington 25, D. C.

OCT 2 1956

RE: FIDEL ALEJANDRO CASTRO RUZ, WA;  
JUAN MANUEL MARQUEZ

I. BACKGROUND DATA

A. Residence

On September 19, 1956, T-1, who has furnished reliable information in the past, advised that he had received unconfirmed information [redacted]

b7D

[redacted] to the effect that CASTRO is presently residing in Mexico City at Calle Panuco #221.

B. Employment

T-1 reported that CASTRO continues in his efforts to further a revolutionary attempt against the government of Cuban President FULGENCIO BATISTA.

T-2, who has furnished reliable information in the past, advised on September 18, 1956, [redacted]

b7D

[redacted]

II. ARREST OF SUBJECT AND ASSOCIATES  
BY MEXICAN NATIONAL SECURITY POLICE

On June 22, 1956, T-3, who has furnished reliable information in the past, advised that on the early morning of the previous day agents of the Mexican National Security Police (Direccion Federal de Seguridad--DFS) had arrested FIDEL CASTRO RUZ and a number of his followers when they had been observed openly carrying firearms. According to T-3, those arrested were FIDEL CASTRO RUZ, [redacted]

b6  
b7C

[REDACTED]

T-3 reported that [REDACTED]

[REDACTED]

b6  
b7C  
b7D

The Mexico City daily newspaper "Excelsior" of June 26, 1956, reported that, on the basis of information obtained through interrogation of the subjects arrested earlier and examination of documents in their possession, the following other persons had been arrested:

[REDACTED]

b6  
b7C

The above-mentioned article stated that at the time of his arrest CASTRO RUZ and several of his associates were traveling in a 1950 model Packard bearing Florida license plates [REDACTED].

b6  
b7C

T-4, who has furnished reliable information in the past, advised on June 28, 1956, [REDACTED]

[REDACTED]

b6  
b7C  
b7D

The Mexico City daily newspaper "Novedades" of June 27, 1956, carried an article which claimed that the DFS had uncovered "Red infiltration of the plot against F. BATISTA." In explanation of the foregoing, the article stated that among the

subjects detained was ERNESTO GUEVARA SERNA, an Argentine national and a political refugee from Guatemala following the overthrow of the ARBENZ government. The article continued that GUEVARA SERNA is an active member of the Mexican-Russian Cultural Institute and that his wife, HILDA GODEA DE GUEVARA, is a Peruvian political refugee. The foregoing article stated the Cuban group had been carrying out an active training program in the use of firearms at a ranch known as "Rancho de Santa Rosa," located near Chalco, State of Mexico, and that the training had been directed by ALBERTO BAYO GIROUT, a naturalized Mexican citizen of Spanish origin who had been a Colonel in the Spanish Civil War.

The article continued that the newspaper had received a letter from BAYO stating that he was being sought by the police and accepting full responsibility for the training and preparation of the Cuban revolutionaries. In the letter he claimed to be the "sole leader of the group" and stated that he would deliver himself to the police if he were promised that he would not be interrogated concerning the movement.

The "Excelsior" of July 10, 1956, reported that on the previous day nineteen subjects had been released by the Ministry of Interior (Gobernacion) and stated that only FIDEL CASTRO RUZ, ERNESTO GUEVARA, CALIXTO GARCIA, and SANTIAGO HIRZEL had been retained because it had been determined that their residence permits for Mexico had expired. Among those listed as having been released was ALBERTO BAYO COSGAYA.

The Mexico City daily newspaper "Novedades" of July 10, 1956, reported the release of nineteen Cubans and the naturalized Mexican citizen, ALBERTO BAYO, and quoted the Director of the Immigration Section of the Mexican Ministry of Interior, Mr. ARCADIO OJEDA, to the effect that the subjects had been released when it was determined that their tourist cards were in order. The article continued that upon being released the Cubans were "invited" to leave Mexico.

The "Novedades" of July 11, 1956, reported that SANTIAGO LIBERATO HIRZEL had been released by Mexican Immigration authorities on the previous day.

The "Excelsior" of July 26, 1956, reported that FIDEL CASTRO RUZ and his two remaining "accomplices" who had continued

in confinement with him had been released by Mexican Immigration authorities and that they immediately had begun seeking entry permits for other countries in order to carry out the requirement of the Mexican authorities that they leave Mexico as soon as possible.

T-5, who has furnished reliable information in the past, advised that

b7D

b7D

b3  
b6  
b7C  
b7E

~~CONFIDENTIAL~~

[REDACTED]

b3  
b6  
b7C  
b7E

V. PRESENT ACTIVITIES OF FIDEL CASTRO RUZ

T-1 advised on September 19, 1956, that he had received information from a person of unknown reliability, [REDACTED]

b7D

[REDACTED]

T-2 advised on September 18, 1956, that [REDACTED]

b7D

[REDACTED]

According to T-2, [REDACTED]

b7D

[REDACTED]

~~CONFIDENTIAL~~

ADMINISTRATIVE PAGE

Extra copies of this report are being provided for possible dissemination to the New York [redacted] Washington Field (WFO [redacted] and Miami [redacted] Offices, and the Legat at Havana ([redacted]). A copy hereof has been disseminated on a circulation basis to the Political Section of the American Embassy [redacted]

b3  
b7E

Contradictory reports have been received to the effect that CASTRO RUZ is in Mexico City and that he has traveled to Costa Rica. Information from [redacted] and [redacted] indicates he is still in Mexico and still active. This office is endeavoring to verify his reported residence address and obtain additional information concerning his activities.

b6  
b7C  
b7D

Careful consideration has been given to each source concealed in this report, and T symbols have been utilized only where the identities of the sources must be concealed.

<u>Identity of Source</u>	<u>Date of Activity and/or Description of Information</u>	<u>Date Received</u>	<u>Agent to Whom Furnished</u>	<u>File No. Where Located</u>
T-1 Confidential Contact [redacted]	Residence and employment of FIDEL CASTRO; continues revolutionary activities	9/19/56	SA [redacted] [redacted] (orally)	Instant report
(concealed by request)	[redacted]	9/19/56	SA [redacted] [redacted] (orally)	Instant report
T-2 Confidential Contact [redacted]	Employment and CASTRO continues revolutionary activities	9/18/56	SA [redacted] [redacted] (orally)	Instant report
(concealed by request)	[redacted]	9/18/56	SA [redacted] L. [redacted] (orally)	Instant report
		7/27/56	SA [redacted] [redacted] (orally)	[redacted]

b6  
b7C  
b7D

b3  
b6  
b7C  
b7D  
b7E

ADMINISTRATIVE PAGE

<u>Identity of Source</u>	<u>Date of Activity and/or Description of Information</u>	<u>Date Received</u>	<u>Agent to Whom Furnished</u>	<u>File No. Where Located</u>	
T-3 [redacted]	Arrest of subject and associates, 6/21/56	6/22/56	SA [redacted] [redacted]	[redacted]	b6 b7C b7D b7E
T-4 [redacted] [redacted] (concealed by request)	[redacted]	6/29/56	SA [redacted] [redacted] (orally)	Instant report	
T-5 SA [redacted] [redacted] who obtained info from [redacted]	[redacted]	9/12/56	SA [redacted] [redacted] (orally)	Instant report	b6 b7C b7D
[redacted]	[redacted]	[redacted]	[redacted]	[redacted]	
[redacted]	[redacted]	[redacted]	[redacted]	[redacted]	
Info from [redacted] [redacted] [redacted]	[redacted]	6/26/56	SA [redacted] [redacted] (orally)	Instant report	b6 b7C b7D
T-6 [redacted] [redacted]	[redacted]	[redacted]	Legat	[redacted]	b3 b7E
[redacted]	[redacted]	[redacted]	[redacted]	[redacted]	

LEAD

MEXICO CITY

AT MEXICO, D. F., MEXICO:

Will endeavor to verify subject's residence in Mexico City and continue to follow and report his activities and status.



ADMINISTRATIVE PAGE

REFERENCES

Report of SA  Havana, 8/14/56.  
Mexico City airgram to Bureau dated 8/6/56.

b6  
b7c

TO: SAC, Washington Field

For information

For appropriate action

[Redacted]	
SEARCHED [Redacted]	INDEXED [Redacted]
SERIALIZED [Redacted]	FILED [Redacted]
OCT 23 1956	
FBI - WASHINGTON	
[Redacted]	[Redacted]
[Redacted]	

b3  
b6  
b7C  
b7E

# FEDERAL BUREAU OF INVESTIGATION

C

REPORTING OFFICE <b>MEXICO, D. F.</b>	OFFICE OF ORIGIN <b>BUREAU</b>	DATE <b>MAR 18 1957</b>	INVESTIGATIVE PERIOD <b>3/8, 11/57</b>
TITLE OF CASE <b>FIDEL ALEJANDRO CASTRO RUZ, wa.; JUAN MANUEL MARQUEZ</b>		REPORT MADE BY [REDACTED]	TYPED BY [REDACTED]
		CHARACTER OF CASE [REDACTED]	

b3  
b6  
b7C  
b7E

SYNOPSIS:

FIDEL ALEJANDRO CASTRO RUZ and a group of his revolutionary followers are reported to have departed Mexico clandestinely by private yacht on 11/25/56. In a twelve-page leaflet-size newspaper entitled, "Revolucion," and dated "the first half of February, 1957," the claim is made that CASTRO and his group continue to combat the BATISTA Government from their hideout in the "Sierra Maestra" mountains of Cuba. JUAN MANUEL MARQUEZ arrived in Mexico City from Miami on 1/4/56, and reportedly was in consultation with CASTRO before he returned to Miami. Informant speculates

[REDACTED]

b7D

- RUC -

APPROVED	SPECIAL AGENT IN CHARGE	DO NOT WRITE IN SPACES BELOW	
COPIES MADE: 11 - Bureau [REDACTED] 1 - American Embassy [REDACTED] 1 - Mexico City [REDACTED]		[REDACTED]	[REDACTED]

b3  
b6  
b7C  
b7E

SEARCHED [REDACTED] INDEXED [REDACTED]  
SERIALIZED [REDACTED] FILED [REDACTED]  
**APR 8 1957**  
FBI - WASHINGTON  
[REDACTED]

~~CONFIDENTIAL~~

UNITED STATES DEPARTMENT OF JUSTICE  
FEDERAL BUREAU OF INVESTIGATION

In Reply, Please Refer to  
File No.

Washington, D. C.

MAR 18 1957

RE: FIDEL ALEJANDRO CASTRO RUZ,  
wa.;  
JUAN MANUEL MARQUEZ

I. PRESENT WHEREABOUTS OF  
FIDEL CASTRO RUZ

On February 25, 1957, T-1, who has furnished reliable information in the past, made available a copy of a twelve-page leaflet-size newspaper bearing the title, "Revolucion," and the designation, "Official Organ of the July 26 Revolutionary Movement, published somewhere in Cuba, first half of February, 1957." T-1 stated that



b7D

One of the principal articles in the above-described leaflet was entitled, "From Mexico to the Sierra Maestra." This article purported to be written by one of the companions of FIDEL CASTRO RUZ and discussed the arrangements made in Mexico in advance for the shipment of arms and personnel and the training of personnel in Mexico prior to their embarking for Cuba. The article related that the group had been betrayed to the Mexican Police by a "traitor" and as a result had lost some equipment as well as three companions who were incarcerated. It continued that on November 25, 1956, eighty-two men had boarded the yacht "Grama" to begin their ocean voyage to Cuba.

On a one-page supplement to the publication, "Revolucion", there appeared a reproduction of a photograph of FIDEL CASTRO RUZ and the following statement:

"Our great leader, Fidel Castro, continues to fight valiantly against the forces of the dictatorship from the Sierra Maestra (mountains), continually gaining to a greater extent the admiration and the support of the Cuban people who see in the movement which he represents the greatest hope for national liberation."

With respect to the activities of subject immediately prior to the departure of his group from Mexico, the following was provided by T-2, who has furnished reliable information in the past, on December 3, 1956:

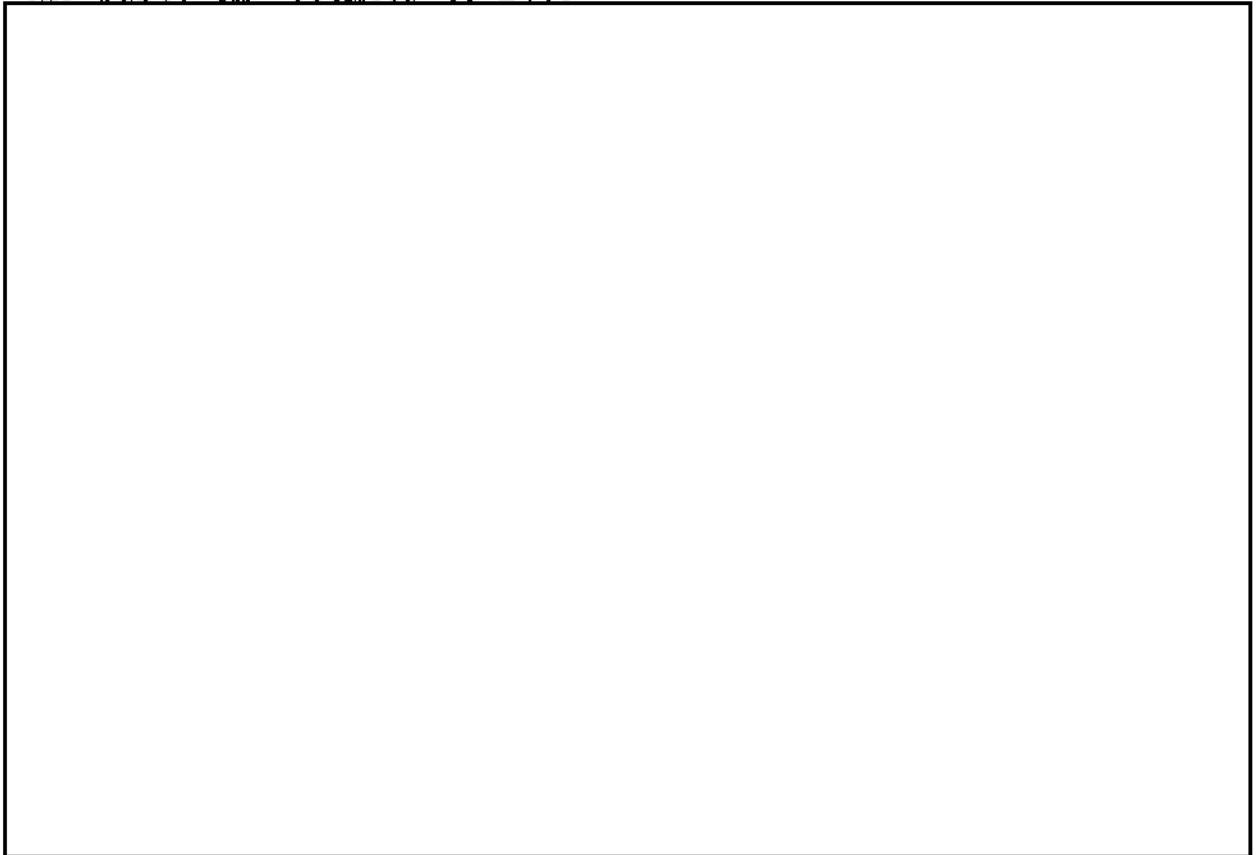

b6  
b7C  
b7D

b7D



b7D

II. TRAVEL TO MEXICO OF  
JUAN MANUEL MARQUEZ

The following information was furnished by T-3, who has furnished reliable information in the past, on November 19, 1956:

[REDACTED]

b6  
b7C  
b7D

On November 22, 1956, T-3 advised that he had

[REDACTED]

b6  
b7C  
b7D

T-4, who has furnished reliable information in the past, advised that JUAN MANUEL MARQUEZ had returned to Miami from Mexico by bus [REDACTED]

[REDACTED]

T-1 advised on November 22, 1956, that he had heard from Cuban acquaintances in Mexico City that JUAN MANUEL MARQUEZ had arrived in Mexico City and was said to be in contact with FIDEL CASTRO RUZ. T-1 also stated that

b6  
b7C  
b7D

[REDACTED]

III. [REDACTED]  
CONCERNING CASTRO RUZ

b7D

The following extract of information relating to CASTRO RUZ was furnished by T-3 on January 28, 1957:

[REDACTED]

b7D

ADMINISTRATIVE

Extra copies of this report are being provided for dissemination to the New York [redacted], Washington Field (WFO [redacted] and Miami (MM [redacted] offices and the Legat at Havana [redacted]

b3  
b7E

A copy hereof has been disseminated on a circulation basis to the Political Section of the American Embassy [redacted]

In view of the fact that it appears to be clearly established that FIDEL CASTRO is presently operating against the BATISTA Government from within Cuba, no further investigation of this case is contemplated by this office, UACB. This office will, however, continue to report such information as is received from its sources concerning other Cuban revolutionary activities in Mexico.

Careful consideration has been given to each source concealed in this report and T symbols have been utilized only where the identities of the sources must be concealed.

SOURCES

<u>Identity of Source</u>	<u>Date of Activity and/or Description of Information</u>	<u>Date Received</u>	<u>Agent to Whom Furnished</u>	<u>File Number Where Located</u>
T-1 Confidential Contact [redacted]	Whereabouts of FIDEL CASTRO and newspaper "Revolucion"	2/25/57	[redacted] (orally)	Instant report
(concealed by request)	Activities of JUAN MANUEL MARQUEZ	11/22/56	[redacted] (orally)	Instant report
T-2 [redacted]	All information	12/3/56	[redacted]	

b6  
b7C  
b7D

ADMINISTRATIVE PAGE

SOURCES

<u>Identity of Source</u>	<u>Date of Activity and/or Description of Information</u>	<u>Date Received</u>	<u>Agent to Whom Furnished</u>	<u>File Number Where Located</u>
---------------------------	---	----------------------	--------------------------------	----------------------------------

T-3

[Redacted]

Arrival of MARQUEZ in Mexico 11/19/56

MARQUEZ outside Mexico City 11/22/56

[Redacted]

1/28/57

[Redacted] re FIDEL CASTRO

[Redacted]

b6  
b7C  
b7D

T-4

[Redacted]

Return of MARQUEZ to Miami (Information in Miami teletype to Bureau dated 11/29/56)

b6  
b7C  
b7D

REFERENCE: Bureau airgram dated 2/6/57

Report of SA [Redacted] dated at Mexico, D. F., 10/2/56.

b6  
b7C

ADMINISTRATIVE PAGE



TO: SAC, Washington Field

For information

For appropriate action

~~Handwritten signature~~

b3  
b6  
b7C  
b7E

[Redacted]	
SEARCHED [ ]	INDEXED [ ]
SERIALIZED [ ]	FILED [ ]
APR 8 1957	
FBI - WASHINGTON	
[Redacted]	

# FEDERAL BUREAU OF INVESTIGATION

~~CONFIDENTIAL~~

REPORTING OFFICE <b>MIAMI</b>	OFFICE OF ORIGIN <b>NEW YORK</b>	DATE <b>JUN 19 1957</b>	INVESTIGATIVE PERIOD <b>11/7,23/56;6/6/57</b>
TITLE OF CASE <b>FIDEL ALEJANDRO CASTRO-RUZ, wa. JUAN MANUEL MARQUEZ</b>		REPORT MADE BY [redacted]	TYPED BY [redacted]
		CHARACTER OF CASE [redacted]	

b3  
b6  
b7C  
b7E

**SYNOPSIS:**

MARQUEZ reportedly last departed Miami clandestinely in 11/56; was reportedly killed fighting in Cuba.

-RUC-

**DETAILS: AT MIAMI, FLORIDA**

On November 7, 1956, [redacted] Aerovias Guest Airlines, Miami, advised that JUAN MANUEL MARQUEZ, described as a Cuban, departed Miami for Mexico on November 4, 1956.

b6  
b7C

On November 23, 1956, Miami Informants T-1 and T-2, both of whom have reported reliable information in the past, advised that MARQUEZ returned to Miami by bus on the night of November 22, 1956. [redacted]

b6  
b7C  
b7D

Subsequently, newspaper reports reflected that JUAN MANUEL MARQUEZ had reportedly been killed in fighting following his landing in Cuba with a contingent of Cuban revolutionaries led by FIDEL CASTRO, which landing took place

APPROVED	SPECIAL AGENT IN CHARGE	DO NOT WRITE IN SPACES BELOW
COPIES MADE: 11 - Bureau [redacted] (RM) 3 - New York [redacted] (RM) 2 - Washington Field [redacted] (RM) 2 - Miami [redacted]		[Large handwritten signature and stamp area] [redacted] SEARCHED _____ INDEXED _____ SERIALIZED _____ FILED _____ <b>JUN 20 1957</b> FBI - WASHINGTON [redacted]

b3  
b6  
b7C  
b7E

DELETE CLASSIFICATION

6-18/25/57

[REDACTED]

b3  
b7E

November 30, 1956.

On several different occasions in December, 1956  
and January and February, 1957, T-1 advised that [REDACTED]

[REDACTED]

[REDACTED] T-1 said that MARQUEZ allegedly  
left the United States by clandestine means in November,  
1956.

b7D

-RUC-

[redacted]

b3  
b7E

-INFORMANTS-

T-1 is [redacted]  
[redacted] who furnished information to SA [redacted]  
on 11/23/56 and on several occasions in December, 1956 and  
January and February, 1957.

b6  
b7C  
b7D

T-2 is [redacted] who reported on  
November 23, 1956 to SA [redacted] instant case.

Careful consideration has been given to each source  
concealed in this report and T-symbols have been used only in  
those instances where identity must be concealed.

-LEADS-

WASHINGTON FIELD:

AT WASHINGTON, D. C.

At Central Office, INS, will check entry and  
departure records for last departure and destination of subject  
JUAN MANUEL MARQUEZ.

-REFERENCES-

5/27/57. Report SA [redacted] New York,

b6  
b7C

-ADMINISTRATIVE PAGE-

DIRECTOR, FBI [redacted] *DR*

7/15/57

b3  
b7E

SAC, WFO [redacted]

FIDEL ALEJANDRO CASTRO-RUZ, was,  
JUAN MANUEL MARQUEZ

b3  
b7E

[redacted]

(OO:NY)

Re report of SA [redacted] dated 6/19/57, at Miami, requesting WFO to check Central Office, INS, for last departure and destination of subject, JUAN MANUEL MARQUEZ.

b6  
b7C

On 7/2/57, SE [redacted] obtained from the Central Office, INS, Washington, D. C., a photostat of the Non-Immigrant Visa and Alien Registration Card of JUAN MANUEL MARQUEZ, which contained the following information:

b6  
b7C

Name	JUAN MANUEL RODRIQUEZ
Home Address	Luisa Quijano #508, Marianao, Cuba
Date of Birth	July 5, 1915 Habana, Cuba
Address in U.S.	Hotel Cortex Miami, Florida
Nearest Relative	[redacted]
Travel Document	Cuban Passport #18684; 8/7/53 to 8/5/58
Race	White
Hair	Brown
Height	5' 7"
Nationality	Cuban
Complexion	Fair
Marital Status	Married
Occupation	Constructor
Purpose of Trip	Pleasure (1 month)
Arrived	PAA FLT. 502, July 19, 1956
Date to Which	August 19, 1956
Admitted	

b6  
b7C

[redacted] Searched \_\_\_\_\_  
Serialized \_\_\_\_\_  
Indexed \_\_\_\_\_  
Filed \_\_\_\_\_

The above card did not list the date of departure or the destination of the subject. RUC.

b3  
b6  
b7C  
b7E

2 = Bureau [redacted] (RM)  
1 = New York [redacted] (RM)  
1 = Miami [redacted] (info) (RM)  
1 = WFO [redacted]

(6)

*RUC*

[redacted]

# Rebels' Leader Predicts Batista's Fall by April 15

By Charles Schuman  
HAVANA, March 30 (AP) — Cuban rebel leader Fidel Castro predicted to this correspondent that the Government of President Fulgencio Batista



United Press

Fidel Castro, leader of rebel forces in Cuba, carries his supper with him in Oriente Province. A Sierra Maestra farmer, who supports the 26th of July Movement, gave the chicken to Castro as he marched through a small town.

and Times Herald guaranteed home delivery.

## "Will Be Different"

"This one will be different," he said.

"While I have been fighting in the Sierras the civilian arm of the 26th of July Movement has been busy laying plans for the strike in the cities.

"All segments of the population are behind us, according to the reports I get. Not labor alone, but doctors and lawyers and students and shopkeepers as well. Just about everybody. And when the strike comes, the Government will be helpless.

"Even Batista's soldiers, trained as they are in bloodletting, cannot kill a whole population."

Castro's organization is called the 26th of July Movement because on that date in 1953 he led a group of 80 students in an attack on the Moncada army barracks in Santiago de Cuba, capital of Oriente Province. The attack failed and Castro spent a period in exile reorganizing his movement.

## Deadline for Troops

Castro said flatly that many Batista soldiers would join his troops "when the time comes." He has given them until April 5 to join him or be marked as "traitors."

"Batista no longer controls his army," Castro said. "He controls only the top brass in the army."

He said he realized he was going out on a limb predicting a quick victory but "that's how the picture looks to me, based on the information I get."

Castro said there was no chance of a negotiated peace now.

"I would speak with Batista only to sign his articles of surrender," Castro said. "He is a gangster and a criminal."

Castro emphasized that he did not plan to assume the presidency himself if he won the war and he said his movement planned no social changes.

"Let me make this clear—ours is a special kind of revolution," he said. "It is political, not social. It is not a revolution of class against class, but of all social classes

*Index  
numbers  
Fidel Castro*

WASHINGTON POST  
& TIMES HERALD 3/31/58  
PAGE A-5 COLUMN 1

SEARCHED	INDEXED
SERIALIZED	FILED
MAR 31 1958	
FBI WASH DC	

b3  
b6  
b7C  
b7E

# Rebels' Leader Predicts Batista's Fall by April 15

By Charles Schuman  
 HAVANA, March 30 (AP)—Cuban rebel leader Fidel Castro predicted to this correspondent that the Government of President Fulgencio Batista will fall by April 15 after a bloody civil war.

"Blood will flow in the streets within the next two weeks," the bearded, 31-year-old revolutionist said.

He made his statement in the course of two formal interviews and several informal conversations during 17 days I spent in and around the rebel mountain hideaway in eastern Cuba's Oriente Province.

Castro plans to open the final phase of his revolution by paralyzing transportation throughout Oriente Province starting Tuesday. He has threatened to embroil Cuba in "total war" unless Batista resigns by next Saturday.

Castro, who has been fighting a guerrilla war against Batista for nearly 16 months, predicted the Government would cave in under the combined pressure of a general strike by the populace and a series of military attacks by his own small armed forces.

### No Date Firm

No precise date for the strike has been announced, but it is expected to begin during the first days of April.

Squatting on the ground at his camp in the Sierra Maestra range, Castro stroked his bushy brown beard, adjusted horn-rimmed glasses on his nose and took a deep puff on a cigarette.

"Batista is a master of repression," he said intently.

"He'll use soldiers against the strikers and blood will flow in the streets within the next two weeks—the blood of soldiers as well as that of bus drivers who refuse to work, of shopkeepers who refuse to open their stores, of cooks and bakers and office workers."

Lean and hard from months of guerrilla fighting and mountain living, Castro stroked a chicken in his arms as he spoke.

"It will be a hard fight but the people are ready this time," he said.

"The revolution is at hand and the people of Cuba are willing to make any sacrifice to rid themselves of this tyrant they have been saddled with for so many years."

### Batista Digs In

The Batista regime, for its part, is digging in to withstand what Castro calls "the final phase" of his campaign.

Batista has asked for emergency powers to declare martial law and impose a country-wide curfew. Congress is expected to give them to him Monday. He is gathering a list of employees and their home addresses so troops can be dispatched to the houses of those who heed the general strike call.

Castro's plan is to start the ball rolling in Oriente, easternmost of Cuba's six provinces and cradle of the revolution. He has called for a halt to all land transportation in Oriente starting Tuesday.

With Oriente as an example, he hopes that by the time the general strike is called the entire country will fall in with it.

He has given orders to his followers to shoot at any vehicle moving in the province after April 1.

Castro said the general strike attempted in Cuba last August failed because it lacked organization.



United Press

Fidel Castro, leader of rebel forces in Cuba, carries his supper with him in Oriente Province. A Sierra Maestra farmer, who supports the 26th of July Movement, gave the chicken to Castro as he marched through a small town.

against the Government against a small army group.

"Batista represents no social class or interest, only the handfuls. Everybody in this country has felt the heavy hand of the Batista dictatorship."

I asked Castro if he was a Communist or if there were Communists in his movement.

"In all its program, the 26th of July Movement has nothing at all to do with communism," he said. "It is possible there are two or three persons in the movement with radical social ideas."

"In this world not every man thinks alike, and in any political movement there may be several Communists. As for myself, I am not at all a Communist."

Castro said he had "no personal ambitions."

"The movement wants magistrate Manuel Urrutia (now in exile in New York) as provisional president until new elections can be held," he said.

"I will remain in the movement which will be the guiding force in the interim government. I seek no material regard other than to satisfy my conscience that I have done my best to help bring democracy and prosperity to my country."

### "Will Be Different"

"This one will be different," he said.

"While I have been fighting in the Sierras the civilian arm of the 26th of July Movement has been busy laying plans for the strike in the cities."

"All segments of the population are behind us, according to the reports I get. Not labor alone, but doctors and lawyers and students and shopkeepers as well. Just about everybody. And when the strike comes, the Government will be helpless."

"Even Batista's soldiers, trained as they are in blood-letting, cannot kill a whole population."

Castro's organization is called the 26th of July Movement because on that date in 1953 he led a group of 80 students in an attack on the Montecada army barracks in Santiago de Cuba, capital of Oriente Province. The attack failed and Castro spent a period in exile reorganizing his movement.

### Deadline for Troops

Castro said flatly that many Batista soldiers would join his troops "when the time comes." He has given them until April 5 to join him or be marked as "traitors."

"Batista no longer controls his army," Castro said. "He controls only the top brass in the army."

He said he realized he was going out on a limb predicting a quick victory but "that's how the picture looks to me, based on the information I get."

Castro said there was no chance of a negotiated peace now.

"I would speak with Batista only to sign his articles of surrender," Castro said. "He is a gangster and a criminal."

Castro emphasized that he did not plan to assume the presidency himself if he won the war and he said his movement planned no social changes.

"Let me make this clear—ours is a special kind of revolution," he said. "It is political, not social. It is not a revolution of class against class, but of all social classes."

*Index  
 Documents  
 X  
 Fidel Castro*

SEARCHED	INDEXED
SERIALIZED	FILED
MAR 31 1956	
FBI - WASH. F. O.	

b3  
 b6  
 b7C  
 b7E

Washington Post & Times Herald  
Sunday, 4/6/58, Pg A5, Col 3

Francis L. McCarthy

HAVANA, April 5 (UP)—The Cuban army chief of staff said tonight that a rebel group personally led by Fidel Castro has been "cut off" from his main force and is being pursued into the mountains of Oriente Province, the Castro stronghold.

Lt. Gen. Pedro Rodriguez Avila said "the saboteurs" operating in the eastern province have been "broken up" and that the body of troops led by Castro has been "isolated" with government forces hot in pursuit.

The announcement indicated a break in the otherwise Easter calm of the island where Castro has threatened "total war" in the "very near future" to overthrow the government of President Fulgenio Batista.

#### Havana Is Quiet

Havana was quiet throughout the day. Rodriguez Avila said Santiago de Cuba and Manzanillo, key cities in Oriente and prime rebel targets, were "completely quiet." No disturbances were reported elsewhere.

Castro has said he commands a fighting force of 2000 men in his 15-month-old campaign against the Batista regime which now appears reaching its climax.

There was belief his threatened "total war" would begin with a general strike, probably on Monday.

Rodriguez Avila said "totally misinformed" and false press reports had given the impression that Castro had been advancing on Santiago and Manzanillo.

Castro's rebel headquarters radio, in the Easter calm before the expected storm, appealed to women and workers to join him and die, if necessary, in the war he has promised to touch off.

Former Cuban President Ramon Grau San Martin gave his blessings to a general strike but was pessimistic about the outcome.

"I'm in favor of any legal means to oust the Batista Government," he said, "but I think the strike will fail because leaders of the Cuban Confederation of Labor are opposing it."

#### Labor Union Denounced

The rebel radio today denounced the confederation leaders and accused them of growing rich at the expense of workers.

[In Washington, a group of political exiles picketed the White House in a campaign to stop U. S. military and economic aid to Cuba and the Dominican Republic.

[They carried signs and banners protesting "illicit" arms shipments by Dominican strongman Rafael Trujillo to Batista.

[In a letter to President Eisenhower and Secretary of State John Foster Dulles, the Dominican and Cuban exiles said the arms were transported in five American-made C-47 airplanes.

They called it an "arrogant attempt" by Trujillo "to crush the Cuban people just as he crushed the Dominicans for 28 years."

In Miami, meantime Cuban air force men today flew three Cuban transport planes out of Miami where they had been stranded when their pilots refused to transport arms, the Associated Press reported. No flight was filed but it was assumed the planes returned to Havana.

[Three other C46 transports belonging to Expresso Aereo Interamericano remain in Miami. Local officials of the company have ordered them stored to prevent their being commandeered by the military pilots.]

b3  
b6  
b7C  
b7E

SEARCHED	INDEXED
SERIALIZED	FILED
APR 6 1958	
FBI - W	F. O.



Washington Post & Times Herald  
Sunday, 4/6/58, P. A5, Col 1 + 2

C

# Group Led by Castro Is Reported 'Cut Off'



Associated Press

**PRESIDENT BATISTA**  
... confident



Associated Press

**FIDEL CASTRO**  
... pledges total war

b3  
b6  
b7C  
b7E

SEARCHED		INDEXED	
SERIALIZED		FILED	
APR 6 1958			
FBI - WASH DC			



[REDACTED]

SEARCHED	INDEXED
SERIALIZED	FILED
JUN 6 1958	
FBI - WASH. F. O.	

[REDACTED]



b3  
b6  
b7C  
b7E

Date

11/5/58

SAC: W. F. O. Field Office

Re:

The enclosed is for your information. If used in a future report  conceal all sources,  paraphrase contents.

Enclosed are corrected pages from report of SA \_\_\_\_\_ dated \_\_\_\_\_

For information.

For appropriate action.

Remarks:

b3  
b6  
b7C  
b7E

40

Enclosure(s)

SEARCHED	INDEXED
SERIALIZED	FILED
NOV 10 1958	
[Redacted]	

*See memo refer  
2-0-66  
Fidel Castro*

### Bullets Spray Castro's Home

HAVANA, Feb. 27 (AP)—Police reported gunfire from a passing car sprayed Fidel Castro's home tonight, but that no one was injured. The Premier was at the Palace at the time attending a Cabinet meeting.

*File*



b3  
b7E

The Washington Post and  
Times Herald.  
Feb. 28, 59.  
Sec. A. P. 1.

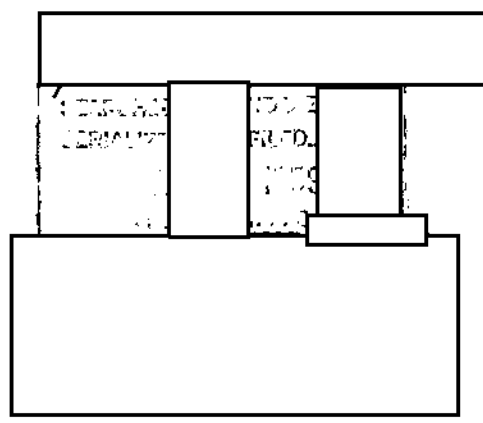

b3  
b6  
b7C  
b7E

[Redacted]

SEARCHED [Redacted] INDEXED [Redacted]  
SERIALIZED [Redacted] FILED [Redacted]  
APR 2 1959  
FBI - St. L. O.

[Redacted]

b3  
b6  
b7C  
b7E

[Redacted]

FBI

Date: *March 31, 1959*

Transmit the following in \_\_\_\_\_

(Type in plain text or code)

Via Airtel

(Priority or Method of Mailing)

- To: SAC, Washington Field
- 2 - Havana (Enclosure)
  - 2 - Jacksonville (Enclosure)
  - 2 - Miami (Enclosure)
  - 2 - New York (Enclosure)
  - 2 - Ottawa (Enclosure)
  - 2 - San Juan (Enclosure)



From: Director, FBI [Redacted]

FIDEL CASTRO

b3  
b7E

ReBulet to State 3/19/59.

Enclosed for each recipient is a copy of [Redacted]

[Redacted]

b3  
b7E

The offices receiving this communication should be alert for any data indicating subversive or anti-Castro demonstrations which may be fomented and any data indicating a threat to Castro's personal safety or that of his group. Sources and informants in a position to acquire this data should be alerted to the necessity for prompt reporting. The Bureau should be promptly advised of any pertinent data received, and any indication of violence against Castro and members of his group should, in addition, be furnished local police officials.

Enclosure [Redacted]

b6  
b7C

SEARCHED.....INDEXED.....  
SERIALIZED.....FILED.....

APR 2 1959

FBI WASH. F. O.

b3  
b6  
b7C  
b7E

Sent Via \_\_\_\_\_

Per [Redacted]

[Redacted]

SEARCHED [Redacted] INDEXED [Redacted]  
SERIALIZED [Redacted] FILED [Redacted]  
APR 7 1959  
[Redacted]

[Redacted]

[Redacted]

b3  
b6  
b7C  
b7E

F B I

Date: 4-7-59

Transmit the following in \_\_\_\_\_  
(Type in plain text or code)

Via Airtel \_\_\_\_\_  
(Priority or Method of Mailing)

To: SAC, Washington Field (Enclosure)  
2 - Newark (Enclosure)  
2 - Boston (Enclosure)

From: Director, FBI [Redacted]

FIDEL CASTRO  
[Redacted]

Re New York tel 4-3-59 captioned "Anti-Fidel Castro Activities." Enclosed for each office is a copy of [Redacted]

WFO immediately advise the local police authorities of the threat against Castro's life, as well as the information concerning the picketing being planned mentioned in retel.

For the information of Newark and Boston, retel reported that New York's source learned that there was allegedly a definite plan to kill Castro when he comes to the U.S. The source did not know where this attack would take place nor the identities of the participants. Since Castro plans to visit Newark and Boston areas, these offices will advise the appropriate local authorities of the threat to kill Castro while he is in the U.S.

The offices receiving this communication should be alert for any data indicating subversive or anti-Castro demonstration which may be fomented and any data indicating a threat to Castro's personal safety or that of his group. Sources and informants in a position to acquire this data should be alerted to the necessity for prompt reporting. The Bureau should be promptly advised of

- 1 - New York (Enclosure)
- 1 - Miami (Enclosure)
- 1 - Ottawa (Enclosure)
- 1 - Havana (Enclosure)

*Handwritten signature*

[Redacted]

SEARCHED \_\_\_\_\_ INDEXED \_\_\_\_\_  
SERIALIZED \_\_\_\_\_ FILED \_\_\_\_\_  
APR 7 1959  
[Redacted]

b3  
b7E

b3  
b7E

b3  
b6  
b7C  
b7E



*Airtel to Washington Field  
Fidel Castro*

*any pertinent data received and any indication of violence  
against Castro and members of his group should, in addition,  
be furnished local police officials.*

b3  
b7E

April 8, 1959

**Airtel**

To: SAC, New Orleans  
- 2 - New York [redacted]

From: Director, FBI [redacted]

**FIDEL CASTRO**  
[redacted]

b3  
b6  
b7C  
b7E

Re New York airtel 4/6/59 which noted Castro plans visit to New Orleans 4/16/59.

For information of New Orleans, a New York source has learned that there is allegedly a definite plan to kill Castro when he comes to the U. S. The source did not know where this attack would take place nor the identities of the participants. Since Castro plans to visit New Orleans, New Orleans will immediately advise the appropriate local authorities of the threat to kill Castro while he is in the U. S.

New Orleans should be alert for any data indicating subversive or anti-Castro demonstrations may be fomented and any data indicating a threat to Castro's personal safety or that of his group. Sources and informants in a position to acquire this data should be alert to the necessity for prompt reporting. The Bureau should be promptly advised of any pertinent data received and any indication of violence against Castro and members of his group should, in addition, be furnished local police officials.

For information of New York any pertinent information relating to Castro's itinerary which differs from that in possession of NYC developed by the Bureau will be furnished NYC for referral to NYCPD. If the NYCPD has not already done so, it should be suggested that it contact the Department of State.

- 1 - Boston
- 1 - Miami
- ① - Washington Field

*Make sure be advised of any info received*

SEARCHED	INDEXED
SERIALIZED	FILED
APR 7 1959	
FBI WASHINGTON	

b3  
b6  
b7C  
b7E

4/6/59

PLAIN TEXT

AIRTEL

TO : DIRECTOR, FBI

FROM : SAC, NEW YORK [redacted]

SUBJECT: FIDEL CASTRO  
[redacted]

*Handwritten:* [redacted]

*Handwritten:* 4-3-59

b3  
b6  
b7C  
b7E

The NY "Daily Mirror" of 4/3/59 contained an article stating that FIDEL CASTRO, Prime Minister of Cuba, had accepted an invitation to speak in NYC on 4/23/59 at a luncheon being given by the Overseas Press Club (OPC). This announcement was made by [redacted]

b6  
b7C

The NY "Journal American" on 4/6/59 in the editorial by BOB CONSIDINE entitled, "On The Line" states that FIDEL CASTRO will visit Columbia University on 4/21/59, the UN on 4/22/59, the OPC luncheon on 4/23/59, and on the evening of 4/23/59 will attend a celebration given by the Cuban colony in NYC.

Detective [redacted] advised on 4/6/59 that he and Detective Sergeant [redacted] Bureau of Special Services, NYC PD, interviewed [redacted]

b6  
b7C

- 3 - Bureau (RM)
- 1 - Boston (INFO) (RM)
- 1 - Miami (INFO) (RM)
- 1 - New Orleans (INFO) (RM)
- ① - Washington Field (INFO) (RM)
- 1 - New York [redacted]
- 1 - New York [redacted]

b3  
b6  
b7C  
b7E

[redacted]  
(10)

SEARCHED	INDEXED
SERIALIZED	FILED
APR 7 1959	
F. O.	

[redacted]  
[redacted], NYC. [redacted] stated that the latest  
itinerary for CASTRO during his visit to the US included the  
following:

4/16/59  
New Orleans

4/17-20/59  
Washington, DC

4/21/59  
Leave Washington via train for Princeton University,  
Princeton, NJ

4/21/59  
Arrive NYC and go to Columbia University and  
then visit to NY "Times"

4/22/59 <sup>R FOUR HOUR</sup>  
UR (for an affair)

4/23/59  
Luncheon, OPC (Astor Hotel)

4/23/59  
Address council on Foreign Relations

4/24/59  
Address Cuban colony at an armory or some other  
appropriate location

[REDACTED]

4/25/59

Leave NYC en route to Boston, Mass.

[REDACTED] stated that while CASTRO is in the NY area he will stay in one of the Hilton hotels and in all probability will not be at the Waldorf-Astoria Hotel as Mrs. MARTA BATISTA is now there.

[REDACTED] stated that [REDACTED] was not too definite about the above itinerary and indicated that it was subject to a change at any moment.

Detective [REDACTED] also stated that he had made an inquiry at the Cuban Tourist Bureau at Rockefeller Center on 4/6/59 and was advised that CASTRO was expected to arrive in New Orleans, La., on 4/16/59 and then proceed to Washington for his official visit. [REDACTED] also stated that it was indicated that CASTRO would be travelling in his private plane to the US which is named "Sierra Maestra."

Lieutenant [REDACTED] Bureau of Special Services, NYC PD, is quite concerned over the planned visit of CASTRO to NYC. Lieutenant [REDACTED] desired to know whether or not the Bureau had any definite itinerary for CASTRO and whether or not any definite plans for appearances have been made as of this date.

[Redacted]

b3  
b7E

The Bureau is respectfully requested to advise the  
NYO of any information received concerning CASTRO'S visit  
to the US and, in particular, in the NYC area in order that  
Lieutenant [Redacted] of the Bureau of Special Services may be  
immediately advised if all security precautions are being taken  
by the NYC PD.

b6  
b7C

4/7/59

PLAIN TEXT

AIRTEL

TO : DIRECTOR, FBI

FROM : SAC, NEW YORK [redacted]

SUBJECT: FIDEL CASTRO [redacted]

*Handwritten:* C  
[redacted]  
[redacted] C.O.  
[redacted] 4-3

b3  
b6  
b7C  
b7E

ReNYairtel 4/6/59.

Detective [redacted] Bureau of Special Services, NYC PD, on 4/7/59, advised USS received telephone call from [redacted] US State Department, NYC, who advised CASTRO'S itinerary in NY as follows:

b6  
b7C

4/21/59  
Columbia University (2:00 p.m. - 5:00 p.m.)  
NY Times (5:30 p.m.)

4/22/59  
UN - luncheon by UN correspondants (12:30 p.m. - 5:00 p.m.)

4/23/59  
Overseas Press Club luncheon (12:30 p.m.)

b3  
b6  
b7C  
b7E

- 3 - Bureau (RM)
- 1 - Boston (Info) (RM)
- 1 - Miami (Info) (RM)
- 1 - New Orleans (Info) (RM)
- 1 - Washington Field (Info) (RM)
- 1 - New York [redacted]
- 1 - New York [redacted]

[redacted] (#31)  
(10)

[redacted]

SEARCHED	INDEXED
SERIALIZED	FILED
APR 8 1959	
F.O.	

[redacted]

b3  
b7E

4/24/59  
Celebration by Cuban colony, NYC  
(no location as yet)

4/25/59  
Leave NYC en route Boston, Mass.

[redacted] according to [redacted], said travelling  
with CASTRO will be the following:

b6  
b7C

[redacted]

b6  
b7C

For information of Bureau and other offices, [redacted]  
[redacted] is probably identical with [redacted]  
[redacted] and [redacted] is probably  
identical with [redacted], who is [redacted]  
[redacted]

b6  
b7C



[redacted]

b3  
b6  
b7C  
b7E

[redacted] also stated that [redacted] said that threats had already been received against CASTRO'S life and that four State Department Agents from Washington, DC, will travel with CASTRO throughout the US. [redacted] stated that the US State Department has requested NYC to afford adequate security at all times for CASTRO'S party while in NYC and that NYC PD afford a lead and follow-up car for the motorcade while in NYC.

[redacted] further advised that all information has been furnished to Police Commissioner STEPHEN P. KENNEDY, NYC PD Commissioner, and that a special conference will be held by NYC PD to map out all arrangements concerning CASTRO'S trip.

b6  
b7C

[Redacted]

b3  
b7E

**Date:** April 6, 1959  
**To:** Mr. E. Tomin Bailey  
Director  
Office of Security  
Department of State  
515 2nd Street, N. W.  
Washington 25, D. C.

Post  
[Redacted]

**From:** John Edgar Hoover, Director  
Federal Bureau of Investigation

**Subject:** FIDEL CASTRO [Redacted]  
[Redacted]

b3  
b7E

A source who is in a position to furnish reliable information advised on April 3, 1959, that he had recently returned from Cuba.

With regard to the anticipated visit of Fidel Castro, Prime Minister of Cuba, to the United States on April 17, 1959, the source stated that [Redacted]

b6  
b7C  
b7D

[Large Redacted Block]

- 2 - Ottawa (See Note, Page 3)
- 1 - Havana
- ① - Washington Field

[Redacted]

SEARCHED	[Redacted]	INDEXED	[Redacted]
SERIALIZED	[Redacted]	FILED	[Redacted]
APR 8 1959			

[Redacted]

b3  
b6  
b7C  
b7E

**Mr. E. Tomlin Bailey**

**Another source who is in a position to furnish reliable information advised on April 2, 1959.**

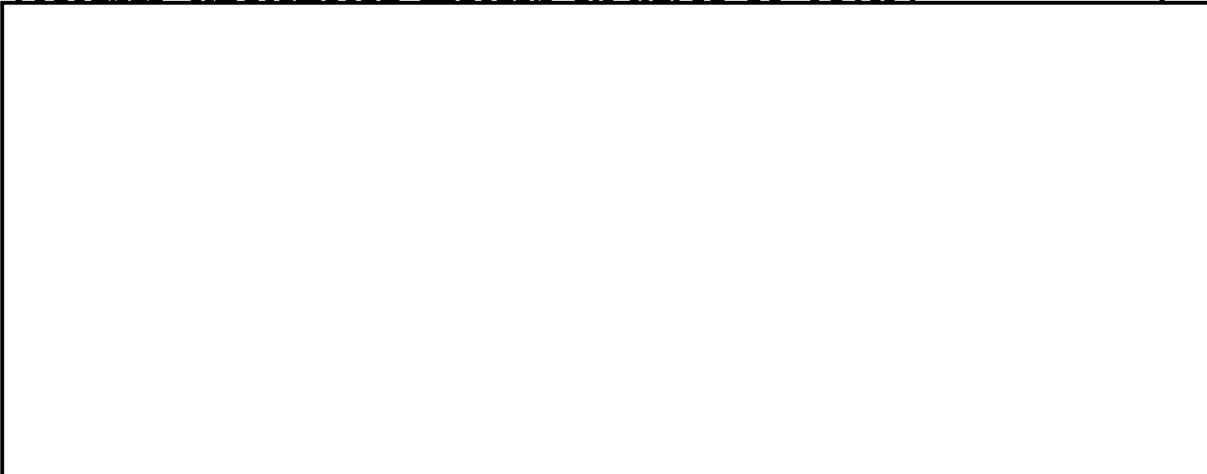

b6  
b7C  
b7D

**The New York City Police Department has been advised of the alleged threat against Castro's life since Castro is expected to be in New York City on April 25, 1959.**

**The above is for your information.**

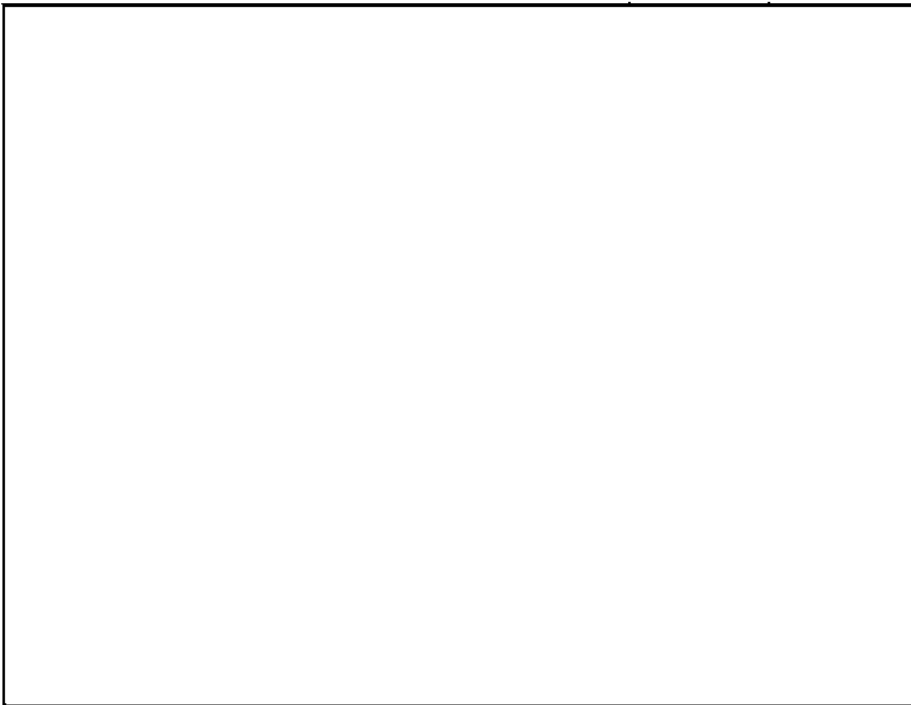

b3  
b6  
b7C  
b7E

Mr. S. Tomlin Bailey

NOTE FOR LEGAL ATTACHE, OTTAWA:

Advice

b7D

F B I

Date: April 8, 1959

Transmit the following in \_\_\_\_\_  
(Type in plain text or code)

Via AIRTEL \_\_\_\_\_  
(Priority or Method of Mailing)

TO: SAC, Washington Field

✓ FROM: Director, FBI [Redacted]

FIDEL CASTRO  
[Redacted]

[Redacted] on 4/7/59 furnished the following information [Redacted]

[Large Redacted Area]

- 1 - Boston
- 1 - New York
- 1 - New Orleans
- 1 - Miami
- 1 - Havana
- 1 - Ottawa
- 1 - Newark

[Redacted]

SEARCHED \_\_\_\_\_ INDEXED \_\_\_\_\_  
SERIALIZED \_\_\_\_\_ FILED \_\_\_\_\_  
APR 10 1959  
FBI - WASH. F. O.

[Redacted]

Sent Via \_\_\_\_\_ M Per \_\_\_\_\_

b3  
b7E

b3  
b6  
b7C  
b7E

b3  
b6  
b7C  
b7E

Airtel to Washington Field  
Re: FIDEL CASTRO

[Redacted]

[Redacted]

b3  
b6  
b7C  
b7E

[Redacted]

b3  
b7E

Washington Field Office should immediately make  
the foregoing information available to the local police  
authorities in paraphrased form

[Redacted]

[Redacted]

b3  
b6  
b7C  
b7E

VPD  
Capt. [Signature]  
4/16/59  
[Redacted]

Director, FBI [redacted]

April 1, 1959

Legat, Havana [redacted]

*P.ell*

b3  
b7E

FIDEL CASTRO [redacted]

[redacted]

[redacted]

ReBulet March 19, 1959, to the State Department.

This office is attempting to ascertain the identities of the individuals who will accompany FIDEL CASTRO to the United States on his proposed trip on April 17, 1959. To date, only one individual has applied for a U. S. visa in connection with this trip, namely, [redacted]. The Bureau was advised concerning this by cable dated March 31, 1959, entitled [redacted].

b3  
b6  
b7C  
b7E

It is to be noted that the U. S. Ambassador at staff conferences has advised that he intends consulting with the Cuban Ambassador to the United States, who is in Havana at the present time, to determine the identities of the individuals planning to accompany CASTRO and also to ascertain CASTRO's itinerary in the United States. The U. S. Ambassador to date has received no official word concerning these plans.

Two extra copies of this letter have been prepared in the event the Bureau desires to furnish them to the New York and Miami offices for information.

4 - Bureau (1-cc: New York  
Miami)

1 - Havana

[redacted]

(5)

b3  
b6  
b7C  
b7E

[redacted]

SEARCHED [redacted]	INDEXED [redacted]
SERIALIZED [redacted]	FILED [redacted]
APR 8 1959	

[redacted]

Date \_\_\_\_\_

SAC: WFD

X For Info.

[REDACTED]	
SEARCHED	INDEXED
SERIALIZED	FILED
APR 8 1959	
[REDACTED]	
[REDACTED]	

b3  
b6  
b7C  
b7E



FBI

Date: April 9, 1959

Transmit the following in \_\_\_\_\_  
(Type in plain text or code)

Via Airtel \_\_\_\_\_  
(Priority or Method of Mailing)

- To: SAC, Washington Field
- 2 - Boston
- 2 - Miami
- 2 - Newark
- 2 - New York
- 2 - New Orleans
- 2 - Ottawa

✓ From: Director, FBI [redacted]

FIDEL CASTRO

[redacted]

[Large redacted block]

An informant who has furnished reliable information in the past advised [redacted]

[redacted]

U.S. offices receiving this communication will immediately make this information available to the local police authorities. Do not identify source named above. Ottawa advise [redacted]

*advised 4/10/59 MPD*  
[redacted]

SEARCHED [redacted]	INDEXED [redacted]
SERIALIZED [redacted]	FILED [redacted]
APR 10 1959	
FBI - WASH. F. O.	

Sent Via \_\_\_\_\_ M

b3  
b7E

b6  
b7C  
b7D

b7D

b3  
b6  
b7C  
b7E

April 9, 1959

**Airtel**

To: SAC, New York

From: Director, FBI

**FIDEL CASTRO**

In connection with forthcoming visit of Castro to the U. S., it is noted he has made numerous statements of derogatory nature concerning current regime in the Dominican Republic and has encouraged Dominican exile groups to overthrow the Trujillo Government. Possibility exists that Dominican agents may attempt reprisals against Castro while he is in U. S.

All offices alert Dominican sources to promptly advise of any data received concerning Dominican-inspired action against Castro or his party. Furnish pertinent information received to Bureau immediately and, where warranted, local police authorities should also be immediately advised.

- 1 - Boston
- 1 - Chicago
- 1 - Miami
- 1 - New Orleans
- 1 - Newark
- 1 - Ottawa
- ① - Washington Field
- 1 - San Juan

*advised*

SEARCHED	INDEXED
SERIALIZED	FILED
APR 10 1959	
FBI - NEW YORK	

b3  
b7E

b3  
b6  
b7C  
b7E

[Redacted]

SEARCHED [Redacted] INDEXED [Redacted]  
SERIALIZED [Redacted] FILED [Redacted]

APR 13 1969

FBI - WASH. F. O.

[Redacted]

b3  
b6  
b7C  
b7E

April 10, 1959

**AIRTEL**

**TO: 540, Washington Field**  
**2 - Boston (Enclosure)**  
**2 - Miami (Enclosure)**  
**2 - Newark (Enclosure)**  
**2 - New York (Enclosure)**  
**2 - New Orleans (Enclosure)**

**From: Director, FBI** [redacted]

**VINCE BARBERO**  
[redacted]

b3  
b7E

**Enclosed for each office is a copy of** [redacted]  
[redacted]

**All offices will note the information contained therein to the effect that Cuban exiles in New York and Washington are planning to spoil Castro's trip to the United States, and that certain persons are hiring Nicaraguans, Puerto Ricans and Cubans to provoke incidents against Castro. All offices will also note the names of the persons listed on page two of the enclosed communication who are named as leaders in provoking unfavorable demonstrations against Castro.**

**All offices will immediately advise the Bureau of any information received concerning this matter particularly on the part of the specific persons named in the enclosure.**

**Enclosure**

**1 - Bureau (Enclosure)**

b3  
b6  
b7C  
b7E

SEARCHED	INDEXED
SERIALIZED	FILED
APR 13 1959	
FBI - WASH. F. O.	

4/10/59

**AIRTEL**

**TO: DIRECTOR, FBI** [redacted] (RM)

**FROM: SAC, BOSTON** [redacted]

**FIDEL CASTRO**  
[redacted]

*Public*  
[redacted]

b3  
b6  
b7C  
b7E

Re Bureau airtel 4/7/59.

On April 9, 1959, [redacted] Harvard Law School, Cambridge, Mass., advised CASTRO visiting Harvard at invitation of Harvard Law School Forum, a student organization. Invitation to CASTRO was extended by [redacted] a Harvard Law School student on behalf of the Harvard Law School Forum.

b6  
b7C

[redacted] stated he will meet with CASTRO as personal representative of Harvard University at Hotel Statler, New York City, on April 24, 1959 and expects to leave New York with CASTRO and group morning April 25, 1959, estimated arrival at Boston noonline, April 25, 1959. CASTRO and party will stay overnight at Ritz-Carlton Hotel, Boston, Mass. and depart Boston April 26, 1959. [redacted] stated reportedly CASTRO and group will have 15 radio, television and newspaper men from Cuba, 13 members of CASTRO's government and 6 Cuban Army guards.

b6  
b7C

[redacted] Harvard University Marshal, advised on April 10, 1959 that FIDEL CASTRO is not a guest of Harvard University. [redacted] stated [redacted] Harvard Law School student, invited CASTRO to address the Harvard Law School

b6  
b7C

- 3 - Bureau [redacted] (RM)
- 1 - Miami (RM)
- 1 - Newark (RM)
- 1 - New Orleans (RM)
- 1 - New York (RM) [redacted]
- 1 - WFO (RM) [redacted]
- 1 - Boston [redacted]

b3  
b6  
b7C  
b7E

[redacted]  
(9)

SEARCHED	INDEXED
SERIALIZED	FILED
APR 13 1959	
[redacted]	

[redacted]

Forum without the courtesy of notifying the University Marshal's Office and CASTRO's acceptance came as a surprise to the University. [redacted] stated that since the Harvard Law School Forum is an organization recognized by Harvard, the University has sanctioned [redacted] action and will make Harvard facilities available to CASTRO and group as guests of the Harvard Law School Forum.

b3  
b6  
b7C  
b7E

Tentatively, to date, according to [redacted] CASTRO and group will dine at Harvard Faculty Club on April 25, 1959 and in the evening of April 25, 1959 Harvard plans to make Harvard Football Stadium available for meeting if weather is fair, otherwise the Harvard Athletic Cage. The Stadium and Cage are located in the City of Boston.

b6  
b7C

To date no anti CASTRO commitments have been reported in the Greater Boston Area.

Appropriate local authorities will be advised of threat to kill CASTRO while in the United States.

[redacted]

b6  
b7C

April 10, 1959

PLAIN TEXT

AIR TEL - AIR MAIL

To: Director, FBI  
 From: SAC, New Orleans [redacted]  
 Re: FIDEL CASTRO  
 [redacted]

*Full*

b3  
 b6  
 b7C  
 b7E

Rebairtel to New Orleans and New York 4/8/59, and New York airtels to Bureau 4/6/59 and 4/7/59, entitled as above. Re New Orleans letter to Bureau 4/8/59 entitled "ANTI-FIDEL CASTRO ACTIVITIES, [redacted]"

b3  
 b7E

PROVOOSTY A. DAYRIES, Superintendent, New Orleans Police Department, was advised 4/10/59 by SA [redacted] that FIDEL CASTRO is alleged to have New Orleans on his itinerary of his visit to the United States, with scheduled arrival in New Orleans on April 16, 1959. DAYRIES was advised that there is allegedly a definite plan to kill CASTRO when he comes to the United States, but that the source of this information was not aware where this attack would take place, nor the identities of the participants.

b6  
 b7C

DAYRIES stated that he has not received any data regarding the impending arrival of CASTRO in New Orleans, nor has he received any request for police protection, and that in the absence of such a specific request, without any specific knowledge of the exact time or place of arrival of CASTRO, that no efforts would be made by him to have police guard present upon CASTRO's arrival.

The Bureau's attention is respectfully directed to

- 3 - Bureau [redacted] (AM - Registered)
- 1 - New York (Info) [redacted] (AM - Registered)
- 1 - Miami (Info) (AM - Registered)
- 1 - Washington Field Office (Info) (AM - Registered)
- 1 - Boston (Info) (AM - Registered)
- 2 - New Orleans

b3  
 b6  
 b7C  
 b7E

[redacted]

(9)

SEARCHED	INDEXED
SERIALIZED	FILED
APR 13 1959	

[redacted]

[REDACTED]

b3  
b7E

referenced New Orleans letter entitled "ANTI-FIDEL CASTRO ACTIVITIES, [REDACTED] concerning the invitation extended to FIDEL CASTRO to speak before a meeting of the Optimist Club in New Orleans on 4/15 or 4/16/59.

As of 4/10/59, [REDACTED] (PROTECT IDENTITY) has advised that [REDACTED]

b6  
b7C  
b7D

Sources at New Orleans have been alerted for any data indicating subversive or anti-Castro demonstrations which may be fomented and any data indicating a threat to CASTRO's personal safety or that of his group. If such information is received, New Orleans will immediately advise the Bureau and appropriate offices.

New Orleans has also alerted Immigration & Naturalization Service authorities at New Orleans to advise of any information in their possession, or which they may receive, relative to the arrival of CASTRO and his group in the area of the New Orleans Division via CASTRO's personal plane or by other mode of travel.

[REDACTED]

b6  
b7C



FEDERAL BUREAU OF INVESTIGATION  
U. S. DEPARTMENT OF JUSTICE  
COMMUNICATIONS SECTION

C

APR 13 1959

[REDACTED]

TELETYPE

b6  
b7C

URGENT 4-13-59 7-29 PM [REDACTED]

TO DIRECTOR, FBI 4 AND SAC, WASHINGTON FIELD  
FROM SAC, NEW YORK 5P

b3  
b6  
b7C  
b7E

FIDEL CASTRO, [REDACTED] DETECTIVE [REDACTED]

NYCPD, ADVISED HE AND LIEUTENANT [REDACTED] MET

WITH [REDACTED] NYC, THIS

DATE. [REDACTED] STATED ALSO PRESENT AT THIS MEETING IN

CONNECTION WITH CASTRO-S VISIT TO US WERE [REDACTED]

b6  
b7C

[REDACTED]

[REDACTED] AND

[REDACTED] STATED THAT ALSO IN NY AT THE PRESENT

TIME IS [REDACTED]

b6  
b7C

AND THE MAN IN CHARGE OF THE SECURITY FOR CASTRO-S VISIT TO  
THE US, WHO IS NOW IN NYC. [REDACTED] THAT THEY WERE MUCH

CONCERNED OVER CASTRO-S TRIP TO THE US AS THEY HAVE INFORMATION  
THAT THERE IS A PLOT TO ASSASSINATE CASTRO WHO IS IN NYC.

END PAGE ONE

SEARCHED [REDACTED] INDEXED [REDACTED]  
SERIALIZED [REDACTED] FILED [REDACTED]

b3  
b6  
b7C  
b7E

APR 13 8 45 PM '59

FBI-WASH. F. O.

BUREAU ADVIS: [REDACTED]

[REDACTED]

[REDACTED]

PAGE TWO

[REDACTED] STATED THAT [REDACTED]

[REDACTED]

b6  
b7C  
b7D

[REDACTED] FURTHER  
STATED, ACCORDING TO [REDACTED] THAT [REDACTED]

[REDACTED]

[REDACTED] SEVERAL DAYS AGO. [REDACTED]

[REDACTED] ON APRIL THIRTEEN, INSTANT, STATED THAT  
IN CONNECTION WITH ANOTHER INVESTIGATION THEY HAD ASCERTAINED  
THAT [REDACTED]

b6  
b7C  
b7E

END PAGE TWO

PAGE THREE



b6  
b7C  
b7E

[REDACTED] ADVISED THAT [REDACTED]

b6  
b7C  
b7D

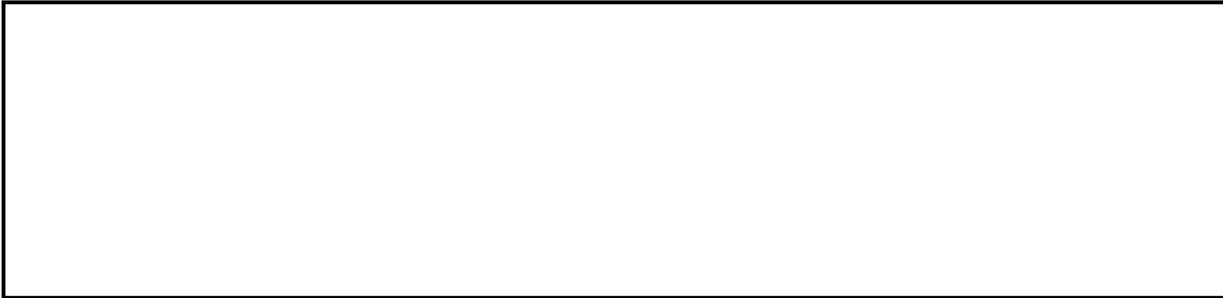

[REDACTED] ADVISED THAT [REDACTED]

b6  
b7C  
b7D



END PAGE THREE

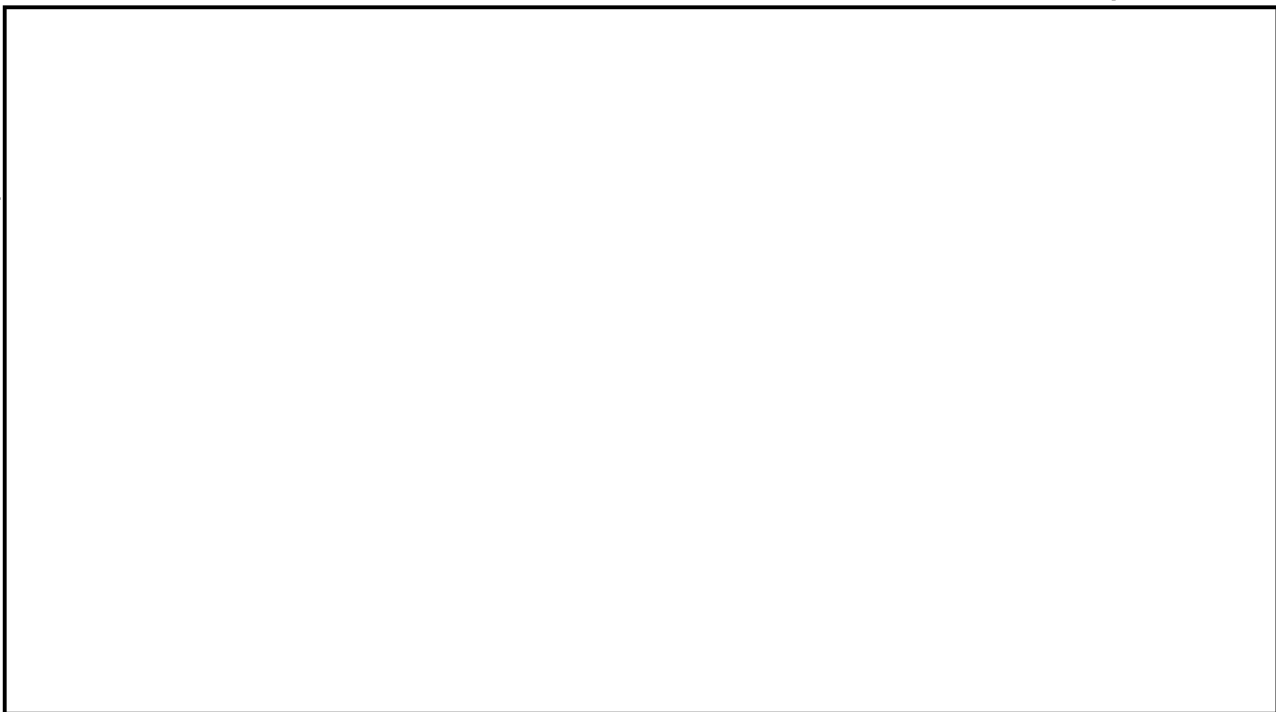

b6  
b7C  
b7D

[REDACTED] ADVISED THAT THE CELEBRATION PLANNED BY THE CUBAN COLONY FOR CASTRO FOR APRIL TWENTY FOUR, NEXT, HAS NOT YET DECIDED ON A PLACE. [REDACTED] SAID THAT THEY CANCELLED THE RESERVATION ON THE THIRTY FOUR STREET ARMORY BECAUSE IT ONLY HAD A CAPACITY OF TEN THOUSAND. [REDACTED] STATED THAT THEY WERE ATTEMPTING TO GET MADISON SQUARE GARDEN, BUT IF THEY CANNOT BECAUSE OF THE CIRCUS, THEY WILL THEN HAVE THE CELEBRATION IN  
END APGE FOUR

b6  
b7C

PAGE FIVE

CENTRAL PARK MALL. [ ] STATED THAT CASTRO IS PREPARED TO  
SPEAK FOR SIX FOR SEVEN HOURS TO THE CUBAN COLONY AT THIS  
CELEBRATION. [ ] ADVISED THAT THE NYO WILL BE KEPT  
ADVISED OF ANY ADDITIONAL INFORMATION REGARDING THIS PLOT TO  
ASSASSINATE CASTRO AND ANY CHANGES IN CASTRO-S ITINERARY.  
MAIL COPIES SENT BOSTON, MIAMI, NEW ORLEANS, NEWARK, SAN JUAN.

END AND ACK PLS

R NY 4 WA CRA

TP

b6  
b7c

Director, FBI [redacted]

April 7, 1959

b3  
b7E

Legat, Havana [redacted]

FIDEL ALBANDRO CASTRO RUZ  
[redacted]

[redacted] advised on April 6, 1959,

[Large redacted block]

b3  
b6  
b7C  
b7E

Extra copies of this letter have been prepared for forwarding by the Bureau to the Washington Field office.

4 - Bureau (2-cc: WFO)

1 - Havana  
[redacted]

(5)

b6  
b7C

[redacted]

b3  
b6  
b7C  
b7E

[redacted]

[redacted]

Date \_\_\_\_\_

SAC: WFO

Legal Attache: \_\_\_\_\_

Re:

The enclosed is for your information. If used in a future report  conceal all sources,  paraphrase contents.

Enclosed are corrected pages from report of SA \_\_\_\_\_ dated \_\_\_\_\_

For information.

For appropriate action.

Remarks:

[Redacted]

SEARCHED	INDEXED
SERIALIZED	FILED
APR 14 1959	

[Redacted]

b3  
b6  
b7C  
b7E

Enclosure(s)

FBI

Date: 4-14-59

Transmit the following in \_\_\_\_\_  
(Type in plain text or code)

Via Airtel \_\_\_\_\_  
(Priority or Method of Mailing)

To: SAC, WFO  
✓ From: Director, FBI [redacted]  
FIDEL CASTRO  
[redacted]

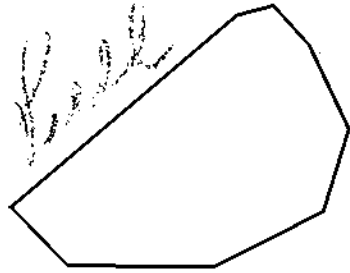

Enclosed for your information is a copy of  
[redacted]  
[redacted]

Enclosure

[redacted]

SEARCHED [ ] INDEXED [ ]  
SERIALIZED [ ] FILED [ ]  
APR 17 1959

[redacted]

Sent Via \_\_\_\_\_

Per \_\_\_\_\_

b3  
b6  
b7C  
b7E

b3  
b7E

b3  
b6  
b7C  
b7E



F B I

Date: 4-15-59

Transmit the following in \_\_\_\_\_  
(Type in plain text or code)

Via Airtel \_\_\_\_\_  
(Priority or Method of Mailing)

To: SAC, WFO - Enclosures (4)  
2 Boston - Enclosures (4)  
2 Miami - Enclosures (4)  
2 Newark - Enclosures (4)  
2 New York - Enclosures (4)  
2 New Orleans - Enclosures (4)  
2 Houston - Enclosures (4)

From: Director, FBI [redacted]

FIDEL CASTRO  
[redacted]

b3  
b7E

ReBuairtel 4-9-59 to WFO and Buairtel to Houston dated 4-14-59. Information was contained in the referenced communications indicating that [redacted]

[redacted]

b6  
b7C  
b7D

The source who furnished the information has [redacted]

[redacted]

b6  
b7C  
b7D

One copy of each of these photographs should be made available to the local police department.

For your additional information, information from [redacted]

[redacted]

b3  
b6  
b7C  
b7E

SEARCHED	INDEXED
SERIALIZED	FILED
APR 15 1959	
[redacted]	
[redacted]	

Sent Via \_\_\_\_\_ M

Per \_\_\_\_\_

April 15, 1959

AIRTEL

TO: DIRECTOR, FBI [redacted]

b3  
b7E

FROM: SAC, WFO [redacted]

FIDEL CASTRO RUZ  
[redacted]

For the information of the Bureau, all pertinent information received by WFO from the Bureau, auxiliary offices and informant coverage has been furnished to the Metropolitan Police Department, Washington, D. C. (MPD) and <sup>and Fairfax Police</sup> in light of information set forth below indicating security responsibility within grounds Mount Vernon, Virginia, will lie with Fairfax County Police Department, this police department will be advised generally of alleged plot for assassination of CASTRO.

On 4/15/59 Captain [redacted] Special Services Squad, MPD, furnished following to SA [redacted]

b6  
b7C

Regarding security measures to be taken concerning CASTRO, a State Security cruiser will be manned by a [redacted] of the State Security Office and two MPD detectives who speak Spanish and who will mingle with CASTRO crowd to pick up any information of value. These detectives are [redacted]

b6  
b7C

According to [redacted] ten men from the State Security Office will be assigned as security detail.

b3  
b6  
b7C  
b7E

- 3 - Bureau
- 1 - Miami (Info)(RM)
- 1 - New York (Info)(RM)
- 1 - Richmond (Info)(RM)
- ① - WFO

[redacted] [redacted]

[redacted]  
(7) [redacted]

A I R T E L

[redacted]

Searched \_\_\_\_\_  
Serialized \_\_\_\_\_  
Indexed \_\_\_\_\_  
Filed \_\_\_\_\_

[redacted]

MPD Cruiser [redacted] will be manned by Detectives [redacted] They will travel with CASTRO at all times, including Embassy functions.

MPD Cruiser [redacted] will be manned by Captain [redacted] and Lieutenant [redacted]

Ten uniformed MPD officers will be stationed at buildings wherein CASTRO will appear, including Embassy, in out of way places to avoid entrance by undesirable persons.

At CASTRO's appearance on "Meet the Press" and "Face the Nation" two additional detectives and 50 additional uniformed officers will be on duty.

[redacted] advised that CID will have 80 men assigned to security detail for CASTRO.

The Park Police will convoy CASTRO from National Airport to ~~White House~~ and to Mount Vernon on 4/19/59.

*Chief of Park Bureau*

Liaison established with Captain [redacted] whereby he will keep WFO advised constantly and on the spot concerning happenings during CASTRO visit. WFO to take no active participation in security measures.

Lieutenant [redacted] Park Police, advised that security of CASTRO at National Airport being supplemented by military. Stated Park Police will detail six men to cover route from Airport to Washington, D. C., including coverage of bridges. Will also maintain coverage on trip to Mount Vernon; however, security within grounds of Mount Vernon will lie with Fairfax County Police Department. Park Police will also provide security, supplemented by MPD officers, at Meridian Hill Park (vicinity of Cuban Embassy), Jefferson and Lincoln Memorials.

On 4/15/59 pursuant to Bureau authority. SAs

[redacted]	PSI
[redacted]	PSI indicated
[redacted]	[redacted]

Shortly after physical contact PSI telephonically advised SA [redacted] of following and stated he would attempt to enlarge on this information and would keep WFO advised on current basis.

b3  
b6  
b7C  
b7E

b6  
b7C

b6  
b7C

b6  
b7C  
b7D

[redacted]

[redacted]

b3  
b6  
b7C  
b7D  
b7E

Captain [redacted] interviewed [redacted] at MPD this date and was advised that 200 anti-CASTRO people to be brought Washington, D. C., from New York City 4/17/59 at instigation of [redacted]. After picketing Washington, D.C., this group will return New York City 9:00 P.M. 4/17/59. This group to be led by [redacted]

b6  
b7C

[redacted] whose identities are known to the Bureau. [redacted] also ascertained from [redacted] that 150 pro-CASTRO people to arrive Washington, D. C., 5:00 P.M. 4/15/59 from New York City to picket at Statler Hotel and then at the Washington National Airport.

It is noted that contact is had with [redacted] twice daily by SA [redacted] and more frequently in the event informant has information of value. On 4/15/59 informant learned [redacted]

b6  
b7C  
b7D

\* [redacted]

According to informant, [redacted]

[redacted]

b6  
b7C  
b7D

Informant also stated [redacted]

[redacted]

\* [redacted]

b7D



b3  
b7E

*Information received from above sources will be furnished the Bureau on a daily basis.*

*Information ascertained from different sources of value to other agencies is being submitted in a form suitable for dissemination.*

April 14, 1959

Airtel

To: SAC, Houston

From: Director, FBI [redacted]

FIDEL CASTRO [redacted]

b3  
b6  
b7C  
b7E

The Washington Capital News Service on 4/11/59 reported the following:

[redacted] "Houston-- [redacted] said today Revolutionary Frontier Fidel Castro of Cuba has tentatively accepted an invitation to visit Houston about April 25.

b6  
b7C

[redacted] said the Cuban leader is expected to spend two days in Houston during his tour of the United States and Canada. He was invited here by the Houston Junior Chamber of Commerce."

For the information of Houston, a New York source has learned that there is allegedly a definite plan to kill Castro when he comes to the U. S. The source did not know where this attack would take place nor the identities of the participants.

Enclosures - 2

- 1 - Boston
- 1 - Miami
- 1 - Newark
- 1 - New Orleans
- 1 - New York
- ① - Washington Field

[redacted]

SEARCHED	[redacted]	INDEXED	[redacted]
SERIALIZED	[redacted]	FILED	[redacted]

APR 15 1959

[redacted]

b3  
b6  
b7C  
b7E

Airtel to SAC, Houston  
Re: FIDEL CASTRO

[Redacted]

b3  
b7E

Enclosed for Houston is one copy each of the following:

- (1) Bulet to State Department 4/9/59.
- (2) [Redacted]

Houston will immediately furnish the information given by the New York source and the information in Bulet to State 4/9/59, both referred to above, to local police authorities.

Houston should be alert for any data indicating subversive or anti-Castro demonstrations may be fomented and any data indicating a threat to Castro's personal safety or that of his group. Sources and informants in a position to acquire this data should be alerted to the necessity for prompt reporting. The Bureau should be promptly advised of any pertinent data received and any indication of violence against Castro and members of his group should in addition be furnished local police authorities.

[Redacted] is for your information.

b3  
b7E

SEARCHED	INDEXED
SERIALIZED	FILED
APR 15 1959	
FBI - WASHINGTON	

b3  
b6  
b7C  
b7E

FEDERAL BUREAU OF INVESTIGATION  
U. S. DEPARTMENT OF JUSTICE  
COMMUNICATIONS SECTION

APR 14 1959

TELETYPE

b6  
b7C

URGENT 4-14-59 7-04 PM [redacted]

TO DIRECTOR, FBI 2 AND SAC, WASHINGTON FIELD  
FROM SAC, NEW YORK 2P *fulled* [redacted]

b3  
b6  
b7C  
b7E

FIDEL CASTRO, [redacted] RENVTEL APRIL FOURTEEN, INSTANT.

DETECTIVE [redacted] BSS, NYCPD, ADVISED APRIL FOURTEEN,

INSTANT, THAT THEY HAS SPOKEN TO [redacted]

[redacted] WHO ADVISED THAT

MORE THAT TWO HUNDRED FIFTY DOMINICANS OPPOSED TO FIDEL CASTRO

WILL LEAVE NYC FROM [redacted] VIA

GREYHOUND BUS TO PICKET CASTRO IN WASHINGTON, D.C., ON APRIL

SEVENTEEN. NEXT. CONTRACT FOR SIX BUSES AT GREYHOUND LINES WAS

MADE PER [redacted] AT COST OF THREE HUNDRED SEVENTEEN DOLLARS

b3  
b6  
b7C  
b7E

AND THIRTY CENTS PER BUS AND [redacted] INDICATED THAT POSSIBLY

MORE BUSES MAY BE NEEDED. [redacted] STATED THAT [redacted] SAID THAT

~~CORR LINE NINE WORD FOUR SHLD BE [redacted]~~

END PAGE ONE

SEARCHED [redacted] INDEXED [redacted]  
SERIALIZED [redacted] FILED [redacted]

APR 15 12 00 AM '59

FBI-WASH. F. O.

b3  
b6  
b7C  
b7E



PAGE TWO

✓ THESE PICKETS WOULD DEMONSTRATE OUTSIDE OF HOTEL IN WASHINGTON, D.C., WHERE CASTRO ADDRESSES ASNE GROUP. [REDACTED] FURTHER STATED THAT THEY HAD SPOKEN TO [REDACTED] PAN AMERICAN ANTI DASH COMMUNIST ASSOCIATION, WHO ADVISED THAT HE WAS TAKING APPROXIMATELY ONE HUNDRED PICKETS TO WASHINGTON, D.C., ON APRIL SEVENTEEN, NEXT, TO PICKET CASTRO. [REDACTED] FURTHER STATED THAT DURING CASTRO-S VISIT TO NYC HIS GROUP INTENDS TO PICKET CASTRO EVERY DAY AND AS MUCH AS POSSIBLE DURING HIS NYC VISIT. [REDACTED] ALSO INDICATED THAT CASTRO-S SYMPATHIZERS MAY PROVOKE A BAD INCIDENT DURING CASTRO-S VISIT TO US AND MOST PROBABLY THIS INCIDENT WILL TAKE PLACE IN NYC. MAIL COPIES SENT BOSTON, MIAMI, NEWARK, NEW ORLEANS, AND SAN JUAN. END AND ACK PLS

NY R 2 WA WS

TU<sup>1</sup><sub>4</sub>

b6  
b7c

FEDERAL BUREAU OF INVESTIGATION  
U. S. DEPARTMENT OF JUSTICE  
COMMUNICATIONS SECTION

c

APR 14 1959

TELETYPE

URGENT 4-14-59 11-22 PM [redacted]

TO DIRECTOR, FBI 4 AND SAC, WASHINGTON FIELD

FROM SAC, NEW YORK 5P [redacted]

SUBJECT, FIDEL CASTRO, [redacted]. RNYTEL FOUR THIRTEEN FIFTYNINE.

AT INVITAION OF CAPT. [redacted]

[redacted] TO FIDEL CASTRO, [redacted] WAS INTERVIEWED

IN HIS SUITE AT THE SHERATON HILTON ON NIGHT OF FOUR THIRTEEN FIFTYNINE.

[redacted] WAS WITH [redacted] WHO FORMERLY WAS

TWO OTHER UNIDENTIFIED CUBANS. [redacted] STATED

THAT IN REGARD TO THE ATTEMPT TO ASSASSINATE CASTRO DURING

HIS VISIT TO US, THEY BELIEVE THAT THE MAN MOST CAPABLE

OF DOING THIS WAS [redacted]

[redacted] ALSO STATED THAT OTHER INDIVIDUALS

WHOM THEY WOULD SUSPECT WOULD INCLUDE /FNU/ [redacted] WHO IS

CLOSE TO [redacted]

WHO HAD WORKED FOR [redacted] IN HAVANA.

[redacted] ALSO STATED THAT OTHER INDIVIDUALS

WHO ARE OPPOSED TO CASTRO AND MAY SEEK TO DO HARM TO

CASTRO ARE [redacted] FROM THE CUBAN GOVERNMENT HAS

END PAGE ONE

SEARCHED [redacted] INDEXED [redacted]  
SERIALIZED [redacted] FILED [redacted]

APR 15 12 00 AM '59

FBI-WASH. F. O.

b3  
b6  
b7C  
b7E

b6  
b7C

b6  
b7C

b6  
b7C

b6  
b7C

b3  
b6  
b7C  
b7E

BUREAU ADVISED

PAGE TWO

BRANDED AS A TRAITOR, [REDACTED]

[REDACTED]  
AND [REDACTED]

[REDACTED] AND WHO IS BELIEVED TO BE WITH [REDACTED] IN NYC.

[REDACTED] STATED THAT THEY HAD ALSO ASCERTAINED

THAT PICKETS WERE BEING SENT IN CHARTERED BUSES FROM NY  
TO WASHINGTON, D.C. AND THAT THIS GROUP INCLUDED  
DOMINICANS AND CUBANS, WHO WERE BEING PAID FIFTY DOLLARS A DAY  
TO PICKET CASTRO AND THAT THESE PICKETS WERE HIRED BY

[REDACTED] WHO WAS WORKING WITH [REDACTED]

[REDACTED] ALSO STATED THAT THEY HAD

HEARD THAT FORMER BRIGADIER GENERAL FRANCISCO "CILITO"  
TABERNILLA HAD HIRED PICKETS TO GO TO WASHINGTON, D.C.  
AND NYC AT A COST OF ONE HUNDRED PER DAY.

[REDACTED] STATED THAT THEY HAD NO

FURTHER DETAILS REGARDING AN ALLEGED PLOT ON PART OF  
END PAGE TWO

b6  
b7C

b6  
b7C

b6  
b7C

PAGE THREE

[REDACTED] AND OTHERS TO ASSASSINATE CASTRO DURING HIS VISIT TO US, BUT STATED THAT IF THEY RECIEVE ANY ADDITIONAL INFORMATION THEY WOULD NOTIFY THE NYCPD AND THE NYO.

b6  
b7C

[REDACTED] WERE INTERVIEWED BY DETECTIVE [REDACTED] [REDACTED] BSS, NYCPD, AND SA [REDACTED] OF NYO.

b6  
b7C

DETECTIVE [REDACTED] ON FOUR FOURTEEN FIFTYNINE, ADVISED THAT HIS OFFICE RECEIVED TELEGRAM FROM METROPOLITAN PD CONCERNING PICKETS ARRIVING FROM NY. [REDACTED] STATED AT ONE THIRTY AM, FOUR FOURTEEN FIFTYNINE, MEMBERS OF BSS WENT TO [REDACTED]

[REDACTED] AND INTERVIEWED INDIVIDUALS PRESENT, WHO INCLUDED THE FOLLOWING... [REDACTED]

b6  
b7C

CORR LINE 17 LAST WORD SHLD BE "THREE"

END PAGE THREE

PAGE FOUR

HIM. [REDACTED] STATED THAT [REDACTED] ACTED AS SPOKESMAN FOR THE ABOVE

b6  
b7C

GROUP, WHO ALL LIVED IN A SMALL APARTMENT AT A  
PRIVATE HOME AT [REDACTED]

CLAIMED THEY HAD NO FIREARMS AND CONSENTED TO A SEARCH  
OF THE APARTMENT, WHICH WAS NEGATIVE.

[REDACTED] DENIED ANY KNOWLEDGE OF A PLOT TO KILL

b6  
b7C

CASTRO OR ANY KNOWLEDGE OF AN ORGANIZED ANTI-CASTRO

DEMONSTRATION. [REDACTED] STATED THAT THE ABOVE SIX INDIVIDUALS

WERE SPONSORED IN THIS COUNTRY BY [REDACTED]

[REDACTED] WHO WAS INTERVIEWED AT THREE THIRTY AM

BY BSS, WHO STATED HE HAD NO INFORMATION REGARDING

PICKETS GOING TO WASHINGTON, D.C. VIA BUS.

b6  
b7C

[REDACTED] ADVISED AT FOUR THIRTY AM [REDACTED]

[REDACTED] PRO-TRUJILLO PICKET LINES, WAS

INTERVIEWED AND STATED HE HAD NO KNOWLEDGE OF A BUS

MOTORCADE LEAVING NYC THIS DATE, BUT THAT THREE OR FOUR BUS LOADS

OF DOMINICAN SYMPATHIZERS OPPOSED TO CASTRO, WILL LEAVE

END PAGE FOUR

b6  
b7c

PAGE FIVE

NYC FROM [REDACTED] FRIDAY, FOUR SEVENTEEN FIFTYNINE, AT SEVEN AM FOR WASHINGTON, D.C., WHERE THEY WILL PICKET CASTRO. LOCATED AT [REDACTED] IS THE MOREL CAMPOS SOCIAL CLUB, WHICH IS A PRO-TRUJILLO ORGANIZATION.

4/15/68

[REDACTED] ALSO STATED THAT [REDACTED] WHO IS ACTIVE IN PRO-TRUJILLO PICKET LINES, WILL ACCOMPANY THIS BUS MOTORCADE TO WASHINGTON, D.C. ON FOUR SEVENTEEN FIVE NINE.

[REDACTED] ALSO ADVISED THAT [REDACTED] WAS INTERVIEWED AT SIX THIRTY AM, FOUR SEVENTEEN FIFTYNINE, AND HE ADVISED HE HAD NO ADDITIONAL INFORMATION CONCERNING PLOT TO ASSASSINATE CASTRO, BUT IF HE RECEIVED ANY ADDITIONAL INFORMATION HE WOULD NOTIFY THE NYCPD. [REDACTED]

b6  
b7c

STATED THAT AT TWO THIRTY, FOUR FOURTEEN FIFTYNINE, OFFICIALS FROM THE POLO GROUNDS WILL MEET WITH REPRESENTATIVES OF CASTRO TO DISCUSS RENTAL OF THE POLO GROUNDS FOR THE CUBAN COLONIES CELEBRATION IN HONOR OF CASTRO TO BE HELD ON FOUR TWENTYFOUR FIFTYNINE.

[REDACTED] STATED THAT IF THEY COULD GET THE POLO GROUNDS FOR  
END PAGE FIVE

b6  
b7c

PAGE SIX

LESS THAN SEVENTY FIVE HUNDRED DOLLARS, WHICH IS NOW THE RENTAL, THEY WILL TAKE THE POLO GROUNDS FOR CASTRO-S PUBLIC APPEARANCE IN NY.

[REDACTED] ON FOUR THIRTEEN FIFTYNINE, STATED THAT AFTER LEAVING NY, CASTRO-S GROUP WILL TRAVEL TO CAMBRIDGE, MASSACHUSETTS, AND FROM THERE WILL GO THE MONTREAL, TORONTO, AND OTTOWA, AFTER WHICH THEY WILL TAKE A DIRECT FLIGHT TO HAVANA. [REDACTED] INDICATED THAT THIS TRIP IS SUBJECT TO CHANGES ANY MOMENT, BUT WILL KEEP THE NYCPD ADVISED OF ANY CHANGES. MAIL COPY SENT BOSTON, MIAMI, NEW ORLEANS, NEWARK AND SAN JUAN.

b6  
b7c

CORR SHLD BE SIX PAGES

END AND ACK PLS

NY R 5 WA ELR

FEDERAL BUREAU OF INVESTIGATION  
U. S. DEPARTMENT OF JUSTICE  
COMMUNICATIONS SECTION

APR 15 1959

TELETYPE

*Handwritten:* [Signature]  
[Handwritten mark]

b6  
b7C

URGENT 4-15-59 2-35 PM ETO

TO DIRECTOR, FBI 2 AND SAC, WASHINGTON FIELD  
FROM SAC, NEW YORK 2 P

FIDEL CASTRO SEMI COLON [REDACTED] RE NEW YORK

b3  
b6  
b7C  
b7E

TELETYPE APRIL FOURTEEN LAST. DETECTIVE [REDACTED] BSS,  
NYCPD, ADVISED APRIL FIFTEEN THAT BUS LOAD OF PRO DASH CASTRO  
SYMPATHIZERS WILL LEAVE FROM CASA CUBA, [REDACTED]

[REDACTED] A . M. OF APRIL FIFTEEN INSTANT. [REDACTED]

b6  
b7C

FURTHER STATED THAT BUS LOAD OF DOMINICANS WHO ARE PRO DASH  
CASTRO WILL LEAVE FROM HOTEL LUZERNE, SEVENTY NINTH STREET AND  
AMSTERDAM AVENUE, NYC, FOR WASHINGTON D. C., TO WELCOME CASTRO  
ON HIS ARRIVAL IN WASHINGTON THIS P. M. [REDACTED] STATED THAT THEY  
SPOKE TO [REDACTED], A DOMINICAN EXILE, [REDACTED]  
ANTI DASH TRUJILLO GROUP KNOWN AS THE FRENTE UNITO DEMOCRATICO  
DOMINICANO. [REDACTED] ANTI DASH TRUJILLO LEADER, STATED

END PAGE ONE

BUREAU ADVISED

[REDACTED]

SEARCHED INDEXED  
SERIALIZED FILED  
APR 15 4 06 PM '59  
[REDACTED]

b3  
b6  
b7C  
b7E



PAGE TWO

THAT AT PUBLIC MEETING OF ALL DOMINICAN EXILE GROUPS HELD AT  
WHITEHALL HOTEL, NYC, ON FEBRUARY EIGHT LAST, [REDACTED] PUBLICALLY  
ADMITTED THAT HE WAS COMMUNIST. DETECTIVE [REDACTED] BSS,  
NYCPD, ADVISED APRIL FIFTEEN INSTANT THAT PLANS TO RENT POLO GROUNDS  
FOR CUBAN COLONY CELEBRATION FOR CASTRO HAVE BEEN CANCELLED BY  
CAPTAIN [REDACTED]  
TOLD [REDACTED] LATE ON APRIL FOURTEEN LAST THAT THEY INTEND TO HOLD  
CUBAN COLONY CELEBRATION AT CENTRAL PARK MALL ON NIGHT OF APRIL  
TWENTY FOUR NEXT, WEATHER PERMITTING. BUREAU AND WFO WILL BE  
KEPT ADVISED OF FURTHER DEVELOPMENTS. MAIL COPIES SENT BOSTON,  
MIAMI, NEW ORLEANS, NEWARK AND SAN JUAN.  
END AND ACK PLS  
NY R 2 WA WS

b6  
b7c

b6  
b7c

FEDERAL BUREAU OF INVESTIGATION  
U. S. DEPARTMENT OF JUSTICE  
COMMUNICATIONS SECTION /

APR 15 1959

b6  
b7C

URGENT 4-15-59 5-32 PM

TELETYPE

TO DIRECTOR, FBI 4 AND SACS, CLEVELAND AND WASHINGTON FIELD,  
BOSTON

FROM SAC, NEW YORK 2P

FIDEL CASTRO, [REDACTED] THE FOLLOWING LETTER, IN  
SPANISH POSTMARKED FOUR SIX FIFTY NINE AT [REDACTED] WAS RECEIVED  
BY [REDACTED] MADE IT AVAILAB

TO THE NYO AND IT APPEARS TO READ AS FOLLOWS, QUOTE [REDACTED]  
FOUR SIX FIFTY NINE. [REDACTED] PARENTHESIS FIRST LINE NOT  
CLEAR IN MEANING, BUT APPEARS THAT SIGNER OFFERS THREE TO  
ONE HUNDRED PESOS CLOSE PARENTHESIS FOR THE HEAD OF THIS BUTCHER  
AND COMMUNIST AND CRIMINAL CASTRO. IT SEEMS A CONTRADICTION  
THAT A PAPER SO CULTURED AND DEMOCRATIC WOULD MENTION THE NAME  
OF SUCH A TRAITOR. SIGNED [REDACTED] CLOSE QUOTE. A POST-  
SCRIPT AT THE BOTTOM OF THE LETTER READS QUOTE I AM HAPPY THAT  
FIDEL CASTRO IS COMING TO THE UNITED STATES, BECAUSE HE-S NOT  
GOING TO LEAVE HERE, AND HE WON-T KILL ANY MORE PEOPLE IN CUBA  
CLOSE QUOTE. THE ENVELOPE REFLECTS RETURN ADDRESS OF [REDACTED]

b3  
b6  
b7C  
b7E

b6  
b7C

b6  
b7C

[REDACTED]

[REDACTED] ADVISED THIS DATE THAT HE DOES NOT KNOW

[REDACTED] HE STATED THAT HE IS THE DISTRIBUTOR OF A BOOK WHICH  
IS THE BIOGRAPHY OF FIDEL CASTRO AND WHICH IS ADVERTISED IN  
QUOTE LA PRENZA CLOSE QUOTE AND QUOTE EL DIARIO CLOSE QUOTE,

b3  
b6  
b7C  
b7E

XX

DAILY SPANISH LANGUAGE NEWSPAPERS PUBLISHED IN NYC. HE ADVISED  
SEARCHED [REDACTED] INDEXED [REDACTED]  
SERIALIZED [REDACTED] FILED [REDACTED]

END PAGE ONE

FILE STRIPPED  
Date: JUN 26 1975  
Initials: [REDACTED]

[REDACTED]

APR 15 7 15 PM '59

BUREAU ADVIS

[REDACTED]

PAGE TWO

THAT ADVERTISEMENT OF THE BOOK WHICH HAD BEEN TORN FROM ONE OF THESE PAPERS WAS ENCLOSED WITH THE LETTER AND IT APPEARS TO BE THE ADVERTISEMENT OF THE BOOK TO WHICH [REDACTED] IS OBJECTING. NYCPD ADVISED OF DETAILS OF LETTER. CLEVELAND REQUESTED TO INTERVIEW [REDACTED] FOR ANY INFORMATION CONCERNING ANTI-FIDEL CASTRO REVOLUTIONARY ACTIVITIES. PERTINENT DETAILS SHOULD BE FURNISHED BUREAU, WFO, NY, BOSTON, IN ORDER TO ADVISE STATE DEPARTMENT AND LOCAL PDS CONCERNED WITH SECURITY DURING VISIT OF CASTRO TO US.  
END AND ACK PLS  
NY R 4 WA WS

b6  
b7c

FEDERAL BUREAU OF INVESTIGATION  
FOI/PA  
DELETED PAGE INFORMATION SHEET  
FOI/PA# 1362425-000

Total Deleted Page(s) = 63

- Page 7 ~ Duplicate;
- Page 8 ~ Duplicate;
- Page 9 ~ Duplicate;
- Page 10 ~ Duplicate;
- Page 15 ~ Duplicate;
- Page 16 ~ Duplicate;
- Page 21 ~ Duplicate;
- Page 23 ~ Duplicate;
- Page 31 ~ b3; b6; b7C; b7D; b7E;
- Page 33 ~ Duplicate;
- Page 51 ~ Duplicate;
- Page 56 ~ Duplicate;
- Page 57 ~ Duplicate;
- Page 58 ~ Duplicate;
- Page 59 ~ Duplicate;
- Page 79 ~ Duplicate;
- Page 80 ~ Duplicate;
- Page 99 ~ b3; b6; b7C; b7D; b7E;
- Page 100 ~ b3; b6; b7C; b7D; b7E;
- Page 115 ~ Duplicate;
- Page 130 ~ b3; b7E;
- Page 144 ~ Duplicate;
- Page 149 ~ b3; b6; b7C; b7E;
- Page 156 ~ b3; b6; b7C; b7E;
- Page 157 ~ b3; b6; b7C; b7E;
- Page 160 ~ b3; b6; b7C; b7D; b7E;
- Page 161 ~ b3; b6; b7C; b7D; b7E;
- Page 167 ~ Duplicate;
- Page 175 ~ b3; b6; b7C; b7E;
- Page 177 ~ b3; b6; b7C; b7E;
- Page 179 ~ b3; b6; b7C; b7E;
- Page 180 ~ b3; b7E;
- Page 182 ~ b3; b6; b7C; b7E;
- Page 183 ~ b3; b7E;
- Page 185 ~ b3; b6; b7C; b7E;
- Page 186 ~ b3; b7E;
- Page 187 ~ b3; b7E;
- Page 188 ~ b3; b7E;
- Page 189 ~ b3; b6; b7C; b7E;
- Page 190 ~ b3; b7E;
- Page 191 ~ b3; b7E;
- Page 192 ~ b3; b7E;
- Page 193 ~ b3; b6; b7C; b7E;
- Page 194 ~ b3; b7E;
- Page 195 ~ b3; b7E;
- Page 196 ~ b3; b7E;
- Page 197 ~ b3; b6; b7C; b7E;
- Page 198 ~ b3; b7E;
- Page 199 ~ b3; b7E;
- Page 200 ~ b3; b7E;
- Page 202 ~ b3; b6; b7C; b7E;
- Page 203 ~ b3; b7E;
- Page 205 ~ b3; b6; b7C; b7E;
- Page 206 ~ b3; b7E;
- Page 209 ~ b3; b6; b7C; b7E;
- Page 210 ~ b3; b6; b7C; b7E;
- Page 211 ~ b3; b7E;
- Page 212 ~ b6; b7C;
- Page 213 ~ b6; b7C;
- Page 214 ~ b6; b7C;
- Page 215 ~ b6; b7C;
- Page 216 ~ b3; b6; b7C; b7E;
- Page 217 ~ b6; b7C;

XXXXXXXXXXXXXXXXXXXXXXXXXXXX  
X Deleted Page(s) X  
X No Duplication Fee X

X For this Page X  
XXXXXXXXXXXXXXXXXXXXXXXXXXXX

~~CONFIDENTIAL~~

b6  
b7C

[redacted]

b3  
b7E

Date: April 14, 1959

To: Mr. L. Conlin Bailey  
Director  
Office of Security  
Department of State  
315 2nd Street, N.W.  
Washington 25, D.C.

*Pushed*  
[redacted]

b3  
b6  
b7C  
b7E

From: John Edgar Hoover, Director  
Federal Bureau of Investigation

Subject: FINES CASE  
[redacted]

b3  
b6  
b7C  
b7E

This will confirm information orally furnished to [redacted] of the Department of State by [redacted] of this Bureau on April 13, 1959.

Detective [redacted] of the New York City Police Department on April 13, 1959, advised that he and Lieutenant [redacted] also of the New York City Police Department, met with [redacted]

[redacted] New York City, on April 13, 1959. [redacted] advised that the meeting had to do with Fidel Castro's visit to the United States and that the following individuals were present: [redacted] the palace guard, Havana, Cuba; [redacted] one of Castro's secretaries; [redacted] Cuban Tourist Bureau, New York City; and one [redacted] not further described. [redacted] advised that [redacted] a captain in the rebel forces and the person in charge of security for Castro's visit to the United States, was also in New York City. [redacted]

b6  
b7C

- 1 - Havana
- 1 - Houston
- ② - WFO - SEE NOTE FOR WFO, PAGE 4

[redacted]

b3  
b6  
b7C  
b7E

SEARCHED [redacted] INDEXED [redacted]  
SERIALIZED [redacted] FILED [redacted]

APR 15 1959

[redacted] [redacted]

~~CONFIDENTIAL~~

~~CONFIDENTIAL~~

Mr. W. Douglas Bailey

stated that they were much concerned over Castro's trip to the United States as they have information that there is a plot to assassinate Castro while he is in New York City.

[redacted] advised the New York City Police Department representatives that [redacted]

[redacted]

b6  
b7C  
b7D

[redacted]

b6  
b7C  
b7E

\* informant, who has furnished reliable information in the past, advised that [redacted]

[redacted]

b6  
b7C  
b7D

~~CONFIDENTIAL~~

Mr. S. Younis Ali

[Redacted]

b7D

The above-mentioned informant further advised that [Redacted]

[Redacted]

b6  
b7C  
b7D

[Redacted] advised that a place for the celebration planned by the Cuban colony for Castro on April 24, 1970, in New York City had not yet been decided upon. [Redacted] advised the New York City Police Department representatives that they canceled a reservation at the 20th Street Casino because it only had a capacity for 10,000. [Redacted] stated that efforts were being made to get Madison Square Garden, but if this could not be obtained because of the crowd, the celebration would then have to be held in Central Park Mall. [Redacted] stated that Castro is prepared to speak for one or more hours at the Cuban colony at this celebration.

b6  
b7C

The above is for your information. We are endeavoring to obtain additional information and, if received, will be made available to you.

[Redacted]

b3  
b7E



**Mr. A. Tamm's Policy**

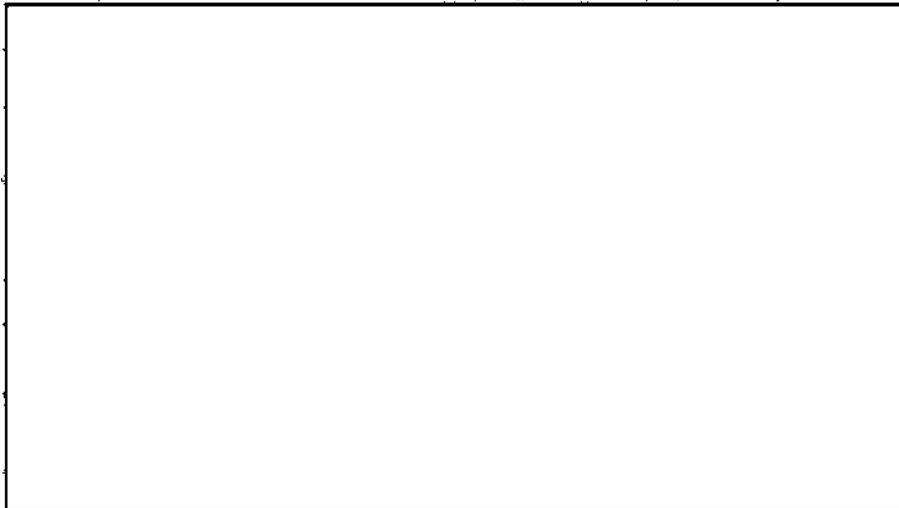

b3  
b7E

**NOTE FOR WFO:**

Re New York tel dated 4-13-59, which reflects that the Hungarian Freedom Fighters were preparing to picket in Washington, D. C., upon Fidel Castro's arrival at the Washington airport. You should promptly furnish this information to local police authorities. The source, of course, should not be disclosed and the information should be paraphrased.

*advised  
press*

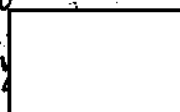

b6  
b7C

4/15/59

**AIRTEL**

**TO: DIRECTOR, FBI** [redacted]

b3  
b7E

**FROM: SAC, WFO** [redacted]

**ANTI-REDUCED CASTRO ACTIVITIES**

[redacted]

On 4/14/59 [redacted]

b3  
b6  
b7C  
b7D  
b7E

[redacted] furnished the following information:

[redacted] has been interviewed recently re case entitled:

[redacted]

[redacted]

[redacted] has recently [redacted]

[Large redacted block]

b6  
b7C  
b7D

On Sunday, April 11, last, [redacted]

[redacted]

b6  
b7C  
b7D

- 3-Bureau
- 1-Miami (Info) (RM)
- 2-New York (Info) (RM)
- 1-San Antonio (Info) (RM)
- 2-WFO

[redacted] (CASTRO)

[redacted]

**AIRTEL**

[Large irregular redacted block]

b3  
b6  
b7C  
b7E

Searched [redacted]  
 Serialized [redacted]  
 Indexed [redacted]  
 Filed [redacted]

[redacted]

[Redacted]

b3  
b6  
b7C  
b7D  
b7E

[Redacted]

On Sunday, 4/19/59,

[Redacted]

b6  
b7C  
b7D

[Redacted]

[Redacted]

b6  
b7C  
b7D

[Redacted]

b3  
b6  
b7C  
b7E

Date: April 15, 1959  
To: Mr. S. Tenth Catley  
Director  
Office of Security  
Department of State  
515 2nd Street, N. E.  
Washington, D. C.

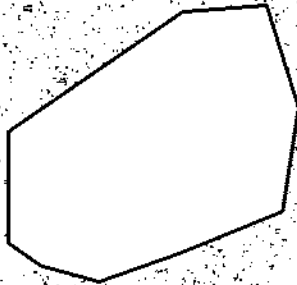

From: John Edgar Hoover, Director  
Federal Bureau of Investigation

Subject: FIDEL CASTRO  
[Redacted]

b3  
b6  
b7C  
b7E

This will confirm information telephonically furnished to [Redacted] of the Department of State on April 14, 1959, by Special Agent [Redacted] of this Bureau.

On April 14, 1959, Detective [Redacted] of the New York City Police Department (NYCPD) advised our New York City Office that representatives of the FICU have been advised by [Redacted] of New York City that more than 250 Dominicans assigned to Castro will leave New York City from [Redacted] via Greyhound bus on April 17, 1959, in order to pick up Castro in Washington, D. C. Reportedly, [Redacted] further advised that this group has contracted for six Greyhound buses at a cost of \$37.20 each and may require additional buses. [Redacted] advised FICU representatives that the group would pick up outside of the hotel in Washington, D. C., where Castro is scheduled to address a meeting of the American Society of Newspaper Editors.

b6  
b7C

According to Detective [Redacted] the New American Anti-Communist Association in New York City, has advised NYCPD representatives that

b3  
b6  
b7C  
b7E

- 1 - Havana
- 2 - WFO - See note page 2

[Redacted]

SEARCHED	INDEXED
SERIALIZED	FILED
APR 16 1959	
F. B. I.	

[Redacted]

Mr. E. Tomlin Bailey

he was taking approximately 100 persons to Washington, D. C., on April 17, 1959, in order to picket Castro. Reportedly, [redacted] said that during Castro's visit to New York City his group plans to picket the subject on a daily basis and as much as possible. [redacted] reportedly further indicated that Castro sympathizers may provoke a "bad incident" during the subject's visit to this country, most probably during Castro's stay in New York City.

b6  
b7C

Concerning [redacted] the attention of the Department of State [redacted] is directed to FBI reports previously furnished these agencies under the caption [redacted] Registration Act, [redacted]. It is noted that on May 3, 1957, [redacted] registered [redacted]

b3  
b6  
b7C  
b7E

Regarding [redacted] the attention of the Department of State [redacted] is directed to FBI reports previously furnished these agencies entitled "Pan American Anti-Communist Association" [redacted]

b3  
b6  
b7C  
b7E

Note for SAC, WFO: WFO should immediately furnish a summary of the pertinent information contained herein to local police authorities.

b6  
b7C

UNITED STATES DEPARTMENT OF JUSTICE

FEDERAL BUREAU OF INVESTIGATION

New York, New York

April 15, 1959

In Reply, Please Refer to  
File No.

Re: Fidel Castro

[Redacted]

b3  
b7E

[Redacted] who presently resides at [Redacted] was interviewed on April 15, 1959, at which time he furnished the following information:

b6  
b7C

[Redacted] stated he now resides at the aforementioned address with [Redacted]

[Redacted] all described as Cuban political exiles who are opposed to Fidel Castro. He said the apartment is rented in the name of [Redacted]

b6  
b7C

[Redacted] claimed that his own job in Cuba was that of [Redacted]

[Redacted] He informed that about 2:00 a.m. on the morning of January 1, 1959, he was personally notified that Batista was fleeing Cuba and that he should make his own departure hastily. He acknowledged that he must have been regarded as unquestionably loyal to Batista in order to receive such notification. However, he spoke lightly of his value to Batista and pointed out that if he had been regarded as highly valuable, he would not now be living in an inexpensive apartment with four other exiles and forced to make a living as a menial factory worker.

b6  
b7C

[Redacted] asserted he has had no contact whatsoever by any means with Batista since he left Cuba. He insisted he knew of no plot to assassinate Fidel Castro in the United States or elsewhere. Nevertheless, it was his opinion that Castro now has the support of only 45 per cent of the Cuban population and is constantly losing support. He believes that Fidel Castro will eventually be assassinated, but that the time would not be ripe before December, 1959. With regard to Castro's current visit to the United States, however, he asserted he knew of no plans to interfere in any way with the published itinerary.

b3  
b6  
b7C  
b7E

[Redacted]

SEARCHED \_\_\_\_\_ INDEXED \_\_\_\_\_  
SERIALIZED \_\_\_\_\_ FILED \_\_\_\_\_  
APR 16 1959  
FBI - WASH. F. O.

b6  
b7C

[redacted] stated that he was also of the opinion that the Cuban people are not ready for democracy. He said Cuba needs a strong man as dictator, but advised that he and many other exiles are opposed to returning Batista to power in Cuba. He informed that he and his exiled friends would support Jose Pedraza for the dictatorship. According to [redacted] Pedraza was an officer in Batista's army and is now in Santo Domingo, Dominican Republic, and he inferred that Pedraza has considerable support. [redacted] also claimed that the ultimate plan to overthrow the Castro government is to launch a coordinated attack of armed forces from Nicaragua, the Dominican Republic and islands adjacent to Cuba. [redacted] stated that these forces have not yet been formed and are not yet staged at these areas.

b6  
b7C

[redacted] declared that neither he nor anyone of his associates has been in contact with any Dominican official and that he personally has no business with either the Cuban or Dominican Consulate in New York City. He further insisted that he is not a fighter, but an intellectual and would have no reason to be called upon to participate in any plot against Castro. He acknowledged that he has a family in Cuba, but stated that he has not been approached or pressured in any way by Castro's men to serve the present Cuban regime.

b6  
b7C

[redacted] declared that he and his associates were not regarded as important and influential in the Batista regime. He stated that in his opinion, the most influential individual among the Cuban exiles in New York City is the former Cuban Senator Rafael Diaz Balart. He advised that he is not aware of Diaz' present address.

b6  
b7C

This is loaned to you by the Federal Bureau of Investigation, and neither it nor its contents are to be distributed outside the agency to which loaned.

FBI

DATE: 4/15/59

Transmit the following in PLAIN TEXT

Via \_\_\_\_\_  
(Priority or Method of Mailing)

TO : DIRECTOR, FBI

FROM : SAC, NEW YORK [redacted]

SUBJECT: FIDEL CASTRO  
[redacted]

b3  
b7E

ReNYteletype to Bureau and WFO 4/13/59.

Per Bureau instructions, [redacted] was interviewed on 4/15/59 by SAS [redacted] and [redacted]

b6  
b7C

[redacted] agreed to furnish NYO any additional information that comes to his attention.

Enclosed for the Bureau are eleven copies of a letterhead memorandum setting forth results of the [redacted] interview. One copy of same is being furnished for the information of the Washington Field Office.

b6  
b7C

- 3 - Bureau (Encl. 11) (RM)
- 1 - Washington Field (INFO) (Encl. 1) (RM)

- 1 - [redacted]
- 1 - [redacted]
- 1 - [redacted]

b3  
b6  
b7C  
b7E

[redacted]  
(8)

Approved: \_\_\_\_\_  
Special Agent in Charge

Sent

SEARCHED \_\_\_\_\_ INDEXED \_\_\_\_\_  
SERIALIZED \_\_\_\_\_ FILED \_\_\_\_\_

M Per APR 16 1959

[redacted] O. [redacted]



FEDERAL BUREAU OF INVESTIGATION  
U. S. DEPARTMENT OF JUSTICE  
COMMUNICATIONS SECTION

b6  
b7C

URGENT 4-16-59 12-28 AM RR  
TO DIRECTOR, 1 AND WFO  
FROM SAC, NEW YORK  
FIDEL CASTRO, [REDACTED]

APR [REDACTED]

TELETYPE

b3  
b6  
b7C  
b7E

DR. RAFAEL L. DIAZ-BALART, FORMER SPEAKER OF THE HOUSE AND SENATOR-ELECT, AND FORMER BROTHER -IN - LAW OF CASTRO, ADVISED AT ELEVEN TWENTY P.M. FOUR FIFTEEN FIFTYNINE THAT HE HAD HEARD A RUMOR THAT EXTREME CARE SHOULD BE TAKEN CONCERNING WHAT CASTRO EATS AND DRINKS DURING HIS VISIT IN THE U.S. DIAZ SAID HE HAD NO FURTHER INFORMATION REGARDING THIS MATTER BUT CONSIDERED IT IMPORTANT ENOUGH TO NOTIFY THIS OFFICE. MAIL COPIES SENT TO BOSTON, MIAMI, NEWARK, NEW ORLEANS, AND SAN JUAN.

END AND ACK PLS

NY R 1 WA ELR<sup>1</sup><sub>4</sub>

*COPIES  
AD PD advised, 4/16/59  
8:30 AM*

[REDACTED]

b3  
b6  
b7C  
b7E

SEARCHED [ ] INDEXED [ ]  
SERIALIZED [ ] FILED [ ]

APR 16 8 12 AM '59

[REDACTED]

[REDACTED]

BUREAU ADVISED

FEDERAL BUREAU OF INVESTIGATION  
U. S. DEPARTMENT OF JUSTICE  
COMMUNICATIONS SECTION

APR 16 1959

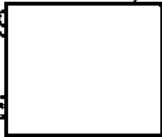

b6  
b7C

TELETYPE

T

URGENT 4-16-59 2-16 PM EST

TO DIRECTOR FBI AND SACS WASHINGTON FIELD, NEW YORK AND BOSTON  
NEW YORK VIA WASHINGTON  
FROM SAC CLEVELAND

FIDEL CASTRO, RE NEW YORK TEL  
APRIL FIFTEEN LAST.

b3  
b6  
b7C  
b7E

IN SUBURBS OF BUT NO SUCH ADDRESS  
AS INQUIRIES PDS, CREDIT BUREAUS,  
DIRECTORIES, CT. RECORDS, SOURCES AMONG SPANISH SPEAKING  
ELEMENT AREA NEGATIVE IN EFFORT TO IDENTIFY  
 NO RECORD EMPLOYMENT OFFICES  
AND UNEMPLOYMENT BUREAUS IN AREA. NO FURTHER EFFORT  
BEING MADE TO IDENTIFY UACB MATTER . RUC.

END ACK PLS

WA 2-17 PM OK FBI WA NM R RELAY

TUM UM OK FBI BS ARI

TU DISC

b3  
b6  
b7C  
b7E

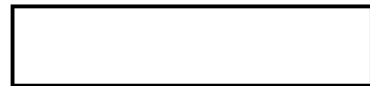

SEARCHED INDEXED

SERIALIZED FILED

APR 16 3 20 PM '59



BUREAU ADVISED RELAYED TO

April 16, 1959

AIRTEL

TO: DIRECTOR, FBI [redacted]

b3  
b7E

FROM: SAC, WFO [redacted]

FIDEL CASTRO RUZ  
[redacted]

Re myairtel 4/15/59.

The following information concerning CASTRO's visit to Washington, D. C., set forth:

It is noted that all pertinent information pertaining to security of CASTRO, as furnished by Bureau, auxiliary offices and sources, has been furnished by WFO to Metropolitan Police Department (MPD), Park Police and Fairfax County Police Department.

The following activities regarding picketing were observed by SAs [redacted] and [redacted].

b6  
b7C

From 4:45 to 5:45 P.M. 4/15/59 approximately 34 individuals carrying 21 signs were observed picketing in an orderly fashion vicinity of White House. Slogans on signs were as follows:

"CASTRO WILL RING PANAMA CANAL WITH COMMUNIST SATELLITES"  
"FIDEL CASTRO -- RED PUPPET"

- 3 - Bureau
- 1 - Miami (Info)(RM)
- 1 - New York (Info)(RM)
- 1 - WFO

[redacted]  
(6) [redacted]

A I R T E L [redacted] [redacted]

b3  
b6  
b7C  
b7E

Searched \_\_\_\_\_  
Serialized [redacted]  
Indexed \_\_\_\_\_  
Filed [redacted]

[redacted]

[redacted]

b3  
b7E

"FIDEL -- NEWEST DICTATOR IN WESTERN HEMISPHERE"  
"GRACIAS FIDEL -- KRUSHCHEV"  
"MARXISM NOW TAUGHT IN CUBA WITH CONSENT OF CASTRO"

It was observed following individuals also present at above picket:

[redacted]

b6  
b7C  
b7D

At 6:30 P.M., approximately 500 pro-CASTRO followers observed at Washington National Airport, Military Air Transport Service. Very few were carrying pro-CASTRO placards. Approximately four of above anti-CASTRO pickets present carrying placards. CASTRO airplane arrived approximately 9:30 P.M. He was convoyed to Cuban Embassy, Washington, D. C., and after conversing on sidewalk with followers, entered Embassy. Captain [redacted] MPD, telephonically advised WFO 10:05 P.M. no incidents had occurred and CASTRO indicated desire to go to bed.

b6  
b7C

On 4/16/59 approximately 25 anti-CASTRO people commenced picketing vicinity of Statler Hotel, Washington, D. C., at 12:15 P.M. under leadership of [redacted] [redacted] observed in vicinity of picketing.

CASTRO arrived Statler 12:30 P.M. for luncheon with Undersecretary of State CHRISTIAN HERTER. No incidents at that time. At approximately 1:00 P.M. [redacted] observed in heated argument in Spanish language with unidentified Latin American male. Argument culminated in exchange of blows, which was quickly broken up by Captain [redacted] MPD, and unidentified MPD lieutenant. Pickets left area 1:15 P.M. without further incident.

b6  
b7C

CASTRO departed Statler Hotel approximately 2:30 P.M., arriving Cuban Embassy approximately 2:40 P.M.

PSI [redacted] telephonically advised SA [redacted] night of 4/15/59 [redacted]

b6  
b7C  
b7D

[redacted]

[Redacted]

[Redacted] on 4/16/59 telephonically advised SA

[Redacted]

b3  
b6  
b7C  
b7D  
b7E

On 4/16/59 [Redacted] advised SA [Redacted]

[Redacted]

b6  
b7C  
b7D

Informant stated [Redacted]

[Redacted]

b6  
b7C  
b7D

[Redacted]

b6  
b7C  
b7D

[redacted]

Informant stated [redacted]

[redacted]

b3  
b6  
b7C  
b7D  
b7E

[redacted] further told [redacted] that [redacted] could

[redacted]

Informant stated [redacted]

[redacted]

b6  
b7C  
b7D

[redacted] was questioned

re possibility this person [redacted]

[redacted] but informant did not know of any connection between  
[redacted] and this person.

b6  
b7C  
b7D

Informant stated [redacted]

[redacted]

b6  
b7C  
b7D

Informant could furnish no information re [redacted]

[redacted]

knew nothing re [redacted] and group mentioned in New York  
City teletype 4/14/59.

Photographs of [redacted] and [redacted] which  
have been furnished to MPD will be exhibited to informant.

b6  
b7C

[redacted]  
[redacted] has furnished information set forth below and in  
airtel 4/15/59 indicating he will be of value in coverage  
of anti-CASTRO activities. On 4/16/59 [redacted] contacted  
SA [redacted]

[redacted]

b6  
b7C  
b7D

[redacted]

[redacted]

b3  
b6  
b7C  
b7D  
b7E

PBI stated that [redacted]

[redacted]

[redacted]

[redacted] He will advise WFO immediately of plans formulated. If information developed re security of CASTRO, this will be immediately furnished appropriate local authorities and the Bureau and auxiliary offices will be advised.

On 4/15/59 [redacted] American-Hungarian Federation, 1761 R Street, N. W., advised SA [redacted] [redacted] had contacted [redacted] for assistance in demonstrations against CASTRO. [redacted] said his organization does not intend to participate.

b6  
b7C

Information of pertinence to other agencies will be submitted in a form suitable for dissemination and the Bureau will be kept advised of happenings on a current basis.

4/16/59

AIRTEL

TO: DIRECTOR, FBI

FROM: SAC, NEW YORK [redacted]

FIDEL CASTRO  
[redacted]

b3  
b7E

ReNYtel, 4/16/59.

Attached are Photostats of the letter described in the referenced teletype which are being furnished for the investigative assistance of the interested Offices. The original letter is being maintained by NYO.

- 3 - Bureau (Enc. 1) (RM) [redacted]
- 1 - Cleveland (Enc. 1) (RM) [redacted]
- 1 - Washington Field (Enc. 1) (RM)
- 1 - New York [redacted]

b3  
b6  
b7C  
b7E

[redacted] (#31)

(7)

b3  
b6  
b7C  
b7E

[redacted]

SEARCHED	INDEXED
SERIALIZED	FILED
APR 17 1959	

[redacted]



AIR TEL - AIR MAIL - REGISTERED

To: Director, FBI  
From: SAC, New Orleans [redacted]  
Re: FIDEL CASTRO  
[redacted]

b3  
b7E

Reairtel to New York 4/9/59, and airtel to Washington Field Office 4/9/59.

[redacted] (Protect Identity), [redacted]

b6  
b7C  
b7D

[Large redacted block]

On April 14, 1959, [redacted] Special Agent, Office of Security, U. S. Department of State, New Orleans, advised that he has received no word from his Washington office indicating that CASTRO would visit New Orleans. In the event [redacted] did receive such information, he stated he would make same available to the New Orleans Division for informational purposes. He also related that in the event CASTRO's visit to New Orleans did materialize, his office would have to provide some type of protection for CASTRO although it was not an official visit to the U. S. In such an instance, he stated he would request assistance from the local police authorities in New Orleans.

b6  
b7C

On April 14, 1959, [redacted] contacted

- 3 - Bureau [redacted]
- 1 - Boston (Info) (AM - Registered)
- 1 - Miami (Info) (AM - Registered)
- 1 - New York (Info) [redacted]
- 1 - Newark (Info) (AM - Registered)
- 1 - Washington Field Office (Info) (AM - Registered)
- 2 - New Orleans (1 - [redacted])

b3  
b6  
b7C  
b7E

[redacted]  
(10)

SEARCHED [ ] INDEXED [ ]  
SERIALIZED [ ] FILED [ ]

APR 17 1959

[redacted] [redacted] [redacted]

FEDERAL BUREAU OF INVESTIGATION  
U. S. DEPARTMENT OF JUSTICE  
COMMUNICATIONS SECTION

APR 17 1959

[Redacted]

b6  
b7C

TELETYPE

URGENT 4-17-59 12-34 PM [Redacted]  
TO DIRECTOR 2 AND SAC WASHINGTON FIELD  
FROM SAC NEW YORK 1P

b3  
b6  
b7C  
b7E

FIDEL CASTRO, [Redacted] DETECTIVE [Redacted] BSS, NYCPD, ADVISED  
FIVE GREYHOUND BUSES LEFT NYC SEVEN FORTY FIVE AM THIS DATE TO PICKET  
FIDEL CASTRO. GROUP COMPOSED MAINLY OF DOMINICANS. [Redacted] STATED  
THAT MORE THAN ONE HUNDRED WERE LEFT HERE IN NY AS THEY DID NOT HAVE  
SUFFICIENT BUSES. [Redacted] SPOKE TO [Redacted] A DOMINICAN WHO  
IS HANDLING THE PICKETING, WHO TOLD HIM THAT THESE PICKETS WERE BEING  
HIRED THROUGH THE DOMINICAN CONSULATE IN NYC. PICKETS INTEND TO RETURN  
TO NY FROM WASHINGTON LATE THIS EVENING ARRIVING [Redacted] AM, APRIL  
EIGHTEEN, NEXT.

b3  
b6  
b7C  
b7E

ND  
NY R 2 WA AR

SEARCHED [Redacted] INDEXED [Redacted]  
SERIALIZED [Redacted] FILED [Redacted]  
APR 17 2 10 PM '59  
BY [Redacted]  
U ADVISED  
[Redacted]

12 48 P

A/



UNITED STATES DEPARTMENT OF JUSTICE  
FEDERAL BUREAU OF INVESTIGATION

In Reply, Please Refer to  
File No.

Houston, Texas  
April 15, 1959

RE: FIDEL CASTRO

[Redacted]

On April 10, 1959, [Redacted]

[Redacted] Houston oil and [Redacted]  
[Redacted] Frank J. Hester Oil Company, Houston, Texas, advised  
that on April 11, 1959, several businessmen from Houston  
were flying to Havana, Cuba, in the private plane of  
[Redacted] to invite FIDEL CASTRO to visit Houston,  
Texas.

[Redacted] identified these men as [Redacted]

[Redacted]

[Redacted] related that information in his possession  
was to the effect that [Redacted] was going to invite  
CASTRO to spend two days in Houston, Texas, on or about  
April 30, 1959, in connection with a proposed tour by  
CASTRO of the United States and Canada.

[Redacted]

[Redacted]  
SEARCHED INDEXED  
SERIALIZED FILE  
APR 17 1959  
[Redacted]

Property of FBI - This memorandum is loaned to you  
and neither it nor its contents are to be distributed  
outside the agency to which loaned.

b3  
b6  
b7C  
b7E

b6  
b7C

b6  
b7C

b3  
b6  
b7C  
b7E

4/13/59

AIRTEL

AIRMAIL

TO: DIRECTOR, FBI [redacted]  
 FROM: SAC, HOUSTON [redacted]  
 RE: FIDEL CASTRO  
 [redacted]

b3  
b7E

Rebunairtel to Houston, 4/16/59.

The Bureau's attention is respectfully directed to Houston airtel to Bureau dated 4/13/59, captioned "Top Hoodlum Progress, Weekly Summary."

For the benefit of offices not receiving copies of referenced Houston airtel to Bureau 4/13/59, [redacted] is

b6  
b7C

[redacted] information has been obtained that [redacted] a New Orleans hoodlum, has been in contact with [redacted] in fact, during the past week was in the Houston office of [redacted] at which time a \$10,000 check was cashed and it is believed the proceeds of this check were possibly given to [redacted].

Enclosed herewith for the Bureau is an original and four copies of a letterhead memorandum relative to information made available to the Houston Division by [redacted]

b6  
b7C

- 3 - Bureau (Encl. 5) (AM-EM)
- 1 - Boston (Encl. 1) (AM) RM
- 1 - Miami (Encl. 1) (AM) RM
- 1 - Newark (Encl. 1) (AM) RM
- 1 - New Orleans (Encl. 1) (AM) RM
- 1 - New York (Encl. 1) (AM) RM
- 1 - WFO (Encl. 1) (AM) RM
- 3 - Houston (1 - 92-34)

b3  
b6  
b7C  
b7E

[redacted]  
(12)

[redacted]

SEARCHED INDEXED  
 SERIALIZED FILED  
 APR 17 1959



b3  
b7E

Copies of this letterhead memorandum are also enclosed for each division receiving copies of this communication.

The data made available to the Houston Division in referenced Bureau airtel to Houston 4/10/59, was disseminated to local authorities at Houston on 4/13/59.

The source of this information, of course, was not disclosed and the information was appropriately paraphrased.

This matter will be followed very closely by the Houston Division and the Bureau will be kept fully advised of any and all pertinent developments in this matter.

b6  
b7C

~~CONFIDENTIAL~~

April 17, 1959

[redacted]

b3  
b7E

A confidential informant, who has furnished reliable information in the past, advised on April 15, 1959, that [redacted]

[redacted]

b3  
b7E

A second confidential informant, who has furnished reliable information in the past, advised on April 16, 1959, that [redacted]

[redacted]

b3  
b7E

On April 16, 1959, Lieutenant [redacted] Special Investigations Squad, Metropolitan Police Department, Washington, D. C., advised a Special Agent of the Federal Bureau of Investigation, Washington, D. C., that [redacted]

b6  
b7C

[redacted] purchased from Whelan Drug Company, 1401 H Street, N. W., seven Colt thirty-eight caliber pistols with two-inch barrels and three boxes of thirty-eight caliber ammunition.

Lieutenant [redacted] also advised that [redacted] was also in possession of twelve additional thirty-eight caliber pistols, two-inch barrels, and three more boxes of thirty-eight caliber ammunition.

b6  
b7C

- 5 Bureau [redacted]
- 2 Miami (RM) (1-FIDEL CASTRO)
- 2 New York (RM) (1-FIDEL CASTRO)
- 2 WFO [redacted]

[redacted]

b3  
b6  
b7C  
b7E

(11)

Searched \_\_\_\_\_  
Serialized \_\_\_\_\_  
Indexed \_\_\_\_\_  
Filed \_\_\_\_\_

~~CONFIDENTIAL~~

[redacted]

~~CONFIDENTIAL~~

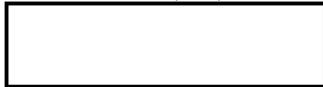

b3  
b7E

This memorandum is loaned to you by the Federal Bureau of Investigation and neither it nor its contents are to be distributed outside the agency to which loaned.

1 12 1

~~CONFIDENTIAL~~

4/17/59

AIRTEL

TO: DIRECTOR, FBI [redacted]

FROM: SAC, WFO [redacted]

b3  
b7E

[redacted]

Enclosed are 5 copies to the Bureau and 2 copies to NY and Miami for info of a letterhead memo dated 4/17/59.

The informant mentioned as having furnished the information in enclosed memo on 4/15/59, is [redacted] and the second informant, who furnished information on 4/16/59, is [redacted]

b3  
b7E

The information contained in enclosed letterhead memo was furnished to SA [redacted] by Lieut. [redacted] Special Investigations Squad, MPD, WDC.

b6  
b7C

The information in enclosed letterhead memo furnished by Lieut. [redacted] was in turn furnished to Lieut. [redacted] of the Bureau of Special Services, NY PD, on 4/16/59, by Captain [redacted] Special Investigations Squad, MPD, WDC.

b6  
b7C

The enclosed memo is classified "~~Confidential~~" [redacted] and since the data reported could reasonably result in the identification of the confidential informants of continuing value and compromise the future effectiveness thereof.

b3  
b7E

- 3 Bureau (Encls. 5)
- 2 Miami (Encls. 2) (RM)
- (1-FIDEL CASTRO)
- 2 New York (Encls. 2) (RM)
- 2 WFO [redacted]

[redacted]

AIRTEL

63

Searched \_\_\_\_\_

Serialized \_\_\_\_\_

Indexed \_\_\_\_\_

Filed \_\_\_\_\_

b3  
b6  
b7C  
b7E

(9)



~~CONFIDENTIAL~~

April 17, 1959

[Redacted]

b3  
b7E

A confidential informant, who has furnished reliable information in the past, advised on April 16, 1959, [Redacted]

[Redacted]

b3  
b6  
b7C  
b7E

[Redacted]

This memorandum is loaned to you by the Federal Bureau of Investigation and neither it nor its contents are to be distributed outside the agency to which loaned.

- 5-Bureau [Redacted]
- 2-Miami (RM)
  - (1-FIDEL CASTRO)
- 2-Newark (RM)
  - (1-FIDEL CASTRO)
- 2-New York (RM)
  - (1-FIDEL CASTRO)
- 2-WFO [Redacted]

[Redacted]

b3  
b6  
b7C  
b7E

[Redacted]

(13)

Searched \_\_\_\_\_  
 Serialized \_\_\_\_\_  
 Indexed \_\_\_\_\_  
 Filed \_\_\_\_\_

[Redacted]

b3  
b6  
b7C  
b7E

4/17/59

AIRTEL

TO: DIRECTOR, FBI [redacted]

FROM: SAC, WFO [redacted]

[redacted]

b3  
b7E

Enclosed are 5 to the Bureau, 2 to Miami, Newark and New York of a letterhead memo dated 4/17/59.

The information in enclosed memo was furnished by [redacted] on 4/16/59.

b3  
b7E

The enclosed memorandum is classified "~~Confidential~~"

[redacted] and since the data reported could reasonably result in identification of the confidential informant of continuing value and compromise the future effectiveness thereof.

- 3-Bureau (Encls.5)
- 2-Miami (RM) (Encls.2)  
(1-FIDEL CASTRO)
- 2-Newark (RM) (Encls.2)  
(1-FIDEL CASTRO)
- 2-New York (RM) (Encls.2)  
(1-FIDEL CASTRO)

② WFO [redacted]

[redacted]

b3  
b6  
b7C  
b7E

[redacted]  
(11)

Searched \_\_\_\_\_  
Serialized \_\_\_\_\_  
Indexed \_\_\_\_\_  
Filed \_\_\_\_\_

AIRTEL

[redacted]

b3  
b7E

~~CONFIDENTIAL~~

April 17, 1959

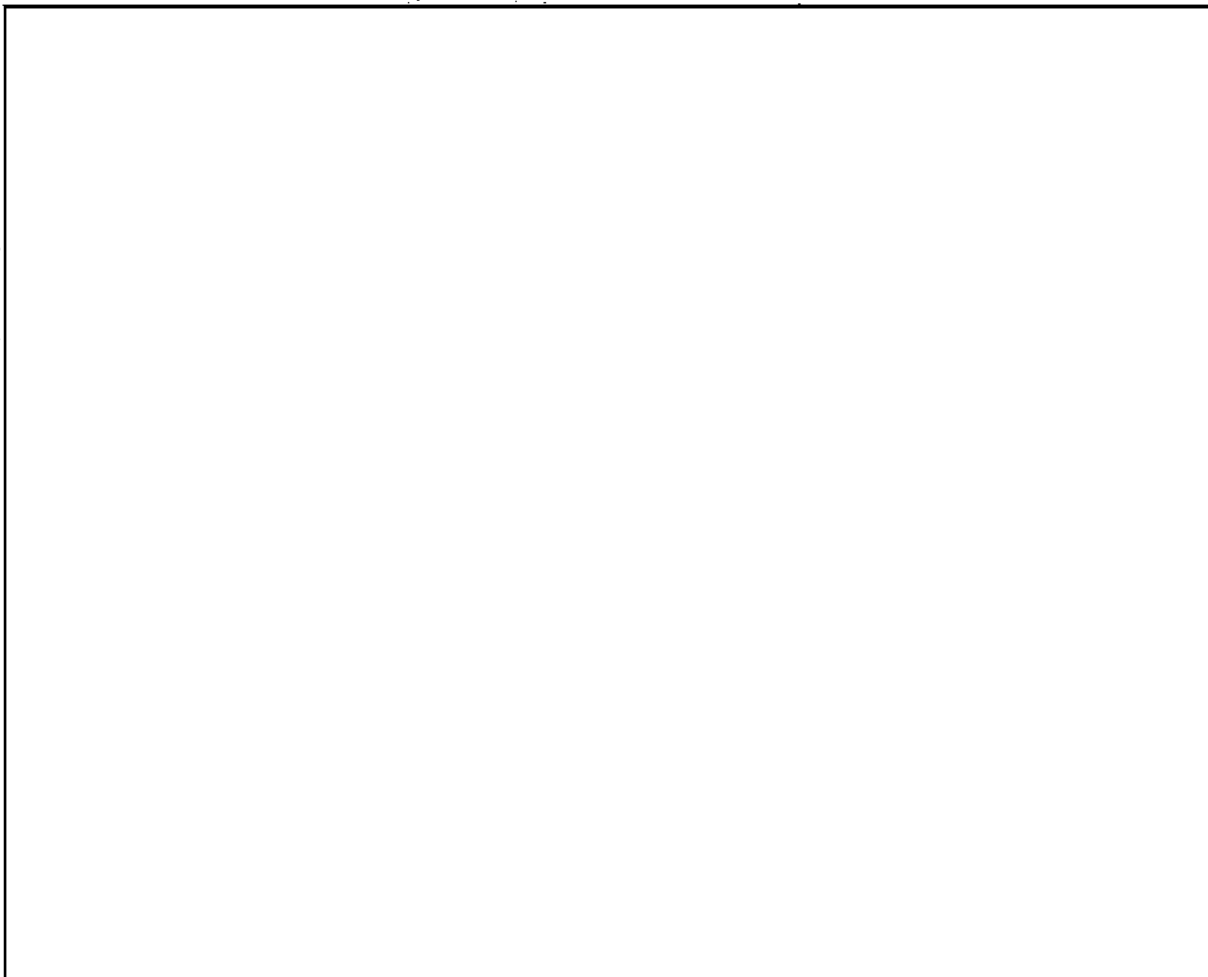

b3  
b7E

This memorandum is loaned to you by the Federal Bureau of Investigation and neither it nor its contents are to be distributed outside the agency to which loaned.

5 Bureau [redacted]  
2 WFO [redacted]  
[redacted]  
[redacted]  
(7)



b3  
b6  
b7C  
b7E

Searched [redacted]  
Serialized [redacted]  
Indexed [redacted]  
Filed [redacted]

~~CONFIDENTIAL~~



b3  
b6  
b7C  
b7E

4/17/59

**AIRTEL**

**TO:** DIRECTOR, FBI [redacted]  
**FROM:** SAC, WFO [redacted]  
[redacted]

b3  
b7E

Enclosed to the Bureau are 5 copies of a letter-head memo dated 4/17/59.

The information in enclosed memo was furnished by [redacted] on 4/16/59.

b3  
b7E

The enclosed memo is classified "~~Confidential~~" [redacted] and since the data reported could reasonably result in identification of the confidential informant of continuing value and compromise the future effectiveness thereof.

3-Bureau (Encls.5)  
②-WFO [redacted]  
[redacted]  
(5)

b3  
b6  
b7C  
b7E

[redacted]

[redacted]

b3  
b6  
b7C  
b7E

**AIRTEL**

Searched \_\_\_\_\_  
Serialized [redacted]  
Indexed \_\_\_\_\_  
Filed [redacted]

~~CONFIDENTIAL~~

~~CONFIDENTIAL~~  
April 17, 1959

[redacted]

b3  
b7E

A confidential informant, who has furnished reliable information in the past, advised on April 16, 1959, [redacted]

[redacted]

b3  
b7E

The informant then learned that [redacted]

[redacted]

This memorandum is loaned to you by the Federal Bureau of Investigation and neither it nor its contents are to be distributed outside the agency to which loaned.

5-Bureau [redacted]

2-Newark [redacted]

②-WFO [redacted]

[redacted]

(9)

b3  
b6  
b7C  
b7E

~~CONFIDENTIAL~~

~~CONFIDENTIAL~~

Searched [redacted]  
Serialized [redacted]  
Indexed [redacted]  
Filed [redacted]

[redacted]

b3  
b6  
b7C  
b7E

4/17/59

**AIRTEL**

**TO: DIRECTOR, FBI** [redacted]

**FROM: SAC, WFO** [redacted]

b3  
b7E

[redacted]

Enclosed for the Bureau are 5 copies of a letterhead memo and 2 to Newark for information, dated 4/17/59.

The information in enclosed memo was furnished by [redacted] on 4/16/59.

b3  
b7E

It should be noted by the Newark Office that the Prime Minister, FIDEL CASTRO, will be departing WDC, via Pa. R.R., 4/20/59, at 4 p.m. to arrive in New Jersey to attend Princeton University that evening. No additional information concerning his visit to Princeton is known by the informant.

Newark Office should furnish local authorities information of alleged plots to assassinate CASTRO.

The Bureau is not engaged in any security measures, but Newark should effect liaison with local authorities to be apprised of any pro or anti CASTRO activities and keep the Bureau and interested offices advised.

The enclosed memo is classified "~~Confidential~~"

[redacted]

[redacted] and since the data reported could reasonably result in identification of the confidential

b3  
b7E

- 3-Bureau (Encls 5)
- 2-Newark (Encls 2) (RM) (Info)
- (1-FIDEL CASTRO)
- 2-WFO

[redacted]

AIRTEL

b3  
b6  
b7C  
b7E

(7)

Searched \_\_\_\_\_

Serialized \_\_\_\_\_

Indexed \_\_\_\_\_

Filed \_\_\_\_\_

[redacted]



b3  
b7E

informant of continuing value and compromise the future effectiveness thereof.

Searched \_\_\_\_\_  
Serialized \_\_\_\_\_  
Indexed \_\_\_\_\_  
Filed \_\_\_\_\_

April 17, 1959

AIRTEL

TO: DIRECTOR, FBI [redacted]

FROM: SAC, WFO [redacted]

FIDEL CASTRO RUZ  
[redacted]

b3  
b7E

Remyairtel 4/16/59.

The following is a summary of activities pertaining to subject since referenced airtel.

At approximately 6:00 P.M. 4/16/59 CASTRO departed Cuban Embassy, walked south 16th Street to Kalorama Road followed by approximately 100 persons. He conversed with individuals in the crowd at 16th and Kalorama for approximately fifteen minutes, crossed 16th Street, and entered Meridian Hill Park. He stayed in park for approximately one hour, entering Cuban Embassy 7:15 P.M. While in park he posed for photographs, kissed babies and engaged in conversations with followers and signed autographs.

Subject departed Cuban Embassy approximately 10:15 A.M. 4/17/59, drove to U. S. Capitol Building and entered Foreign Relations Room, where he remained until approximately 12:20 P.M. He then journeyed to Statler Hotel, arriving 12:30 P.M., for luncheon with American Society of Newspaper Editors.

b6  
b7C

- 3 - Bureau
- 1 - Miami (Info)(RM)
- 1 - New York (Info)(RM)
- 1 - WFO

[redacted]  
(6) [redacted]

A I R T E L

Searched [redacted]  
 Serialized [redacted]  
 Indexed [redacted]  
 Filed [redacted]

b3  
b6  
b7C  
b7E

[redacted]



[redacted]

b3  
b7E

A pro-CASTRO group of approximately 45 men and women picketed south side of K Street between 15th and 16th Streets from 12:30 P.M. until approximately 3:30 P.M.

At 1:30 P.M. five busloads of anti-CASTRO persons believed to be pro-TRUJILLO persons arrived vicinity Statler Hotel. These persons numbered approximately 250 and were permitted to picket south side of K Street between 16th and 17th Streets. Numerous police officers in vicinity and picketing carried on in orderly fashion. At 4:45 P.M. the 250 pickets boarded buses and travelled to 16th and Florida Avenue, not being allowed closer to the Cuban Embassy than the junction of these streets.

CASTRO returned Cuban Embassy 4:50 P.M.

Above activities observed by SAs [redacted]

[redacted] who also observed that [redacted] was present during picketing Statler Hotel. Also present were [redacted]

b6  
b7C  
b7D

Captain [redacted] MPD, advised on evening 4/16/59 that because of [redacted] overbearing attitude concerning pickets he, [redacted] had very sternly made both [redacted] aware of the fact that the MPD would handle the picket lines and that if either of these persons interfered, stern action would be taken against them. On 4/17/59 [redacted] advised that CASTRO would visit Vice President NIXON 7:00 P.M. Sunday at the Capital rather than at NIXON's home.

b6  
b7C

PSI [redacted] advised SA [redacted] on 4/17/59 [redacted] and keep WFO advised.

b6  
b7C  
b7D

PSI [redacted] advised SA [redacted] 4/17/59 [redacted] PSI will keep WFO advised.

b6  
b7C  
b7D

[redacted]

[redacted] on 4/16 and 17/59 advised SA [redacted]

[redacted]

[redacted] Informant could furnish no information concerning planned incidents regarding CASTRO.

With regard to [redacted] PSI [redacted] advised that [redacted]

[redacted]

[redacted], etal.

For the information of the Bureau, all data pertaining to security of CASTRO has been furnished to the MPD, Park Police and Fairfax County Police Department immediately upon receipt. As mentioned in WFO airtel 4/15/59, two MPD detectives are riding with State Department representative and all information furnished to MPD by WFO is verbally furnished to State Department representative on street with MPD.

WFO will submit data of interest to other agencies in form suitable for dissemination and will keep Bureau advised on current basis.

*at 5:00 PM, 250 picked boarded buses and left for NYC, approximately.*

b3  
b6  
b7C  
b7D  
b7E

b6  
b7C  
b7D

FEDERAL BUREAU OF INVESTIGATION  
U. S. DEPARTMENT OF JUSTICE  
COMMUNICATIONS SECTION

APR 19 1959

TELETYPE

URGENT 4-19-59 1-10 PM ETO

TO DIRECTOR AND SAC, WASHINGTON FIELD

FROM SAC, NEW YORK 1 P

FIDEL CASTRO., [redacted] ONE OF LEADERS  
OF JULY TWENTY SIX IN NEW YORK CITY, ADVISED THIS DATE THAT HE  
RECEIVED TELEPHONE CALL FROM WASHINGTON, D. C., LATE ON NIGHT OF  
FOUR EIGHTEEN LAST FROM [redacted]

b3  
b6  
b7C  
b7E

[redacted] WHO STATED THAT HE HAD JUST RECEIVED INFORMATION THAT  
THREE ARMED UNIDENTIFIED CUBANS HAD REGISTERED AT THE STATLER  
HILTON HOTEL, NEW YORK CITY, TO AWAIT ARRIVAL OF FIDEL CASTRO  
IN NEW YORK CITY. ABOVE INFORMATION FURNISHED THIS DATE TO STATE  
DEPARTMENT, NEW YORK CITY, AND NEW YORK CITY POLICE DEPARTMENT.  
BUREAU WILL BE KEPT ADVISED OF ANY FURTHER DEVELOPMENTS.

END

BUREAU ADVISED

1-12 PM OK FBI WA NM

TU  
1  
4

*Handwritten:*  
Notified by phone  
2 pm 4/19/59

*Handwritten:*  
Dest [redacted]  
Special Investigation  
advised 4/19/59

[redacted]	
SEARCHED [redacted]	INDEXED [redacted]
SERIALIZED [redacted]	FILED [redacted]
APR 19 3 12 PM '59	
[redacted]	

b3  
b6  
b7C  
b7E

[Redacted]

2

Date: April 15, 1959

b3  
b7E

To: Mr. A. Smallin Bailey  
Director  
Office of Security  
Department of State  
215 22nd Street, N. W.  
Washington 25, D. C.

From: John Edgar Hoover, Director  
Federal Bureau of Investigation

Subject: FINEA 68120

[Redacted]

b3  
b6  
b7C  
b7E

Reference is made to our letter dated April 14, 1959, captioned as above, which contained information furnished this Bureau on April 13, 1959, by representatives of the New York City Police Department. [Redacted] was described in the referenced letter as [Redacted] for Castro's visit to the United States.

On April 13, 1959, [Redacted] was interviewed at his own request by a Special Agent of our New York Office and a representative of the New York City Police Department. [Redacted] was present during the interview with [Redacted] and [Redacted] as associates of [Redacted] and two other unidentified Cuban nationals.

b6  
b7C

[Redacted] advised they believe the man most capable of assassinating Castro during his visit to the United States is [Redacted]

[Redacted] A Havana, Cuba, [Redacted] said other suspects include an associate of [Redacted] named Paul, first name unknown, and [Redacted] also [Redacted] described as an individual now being sought for capture [Redacted]

b3  
b6  
b7C  
b7E

- 1 - Havana
- 1 - Ottawa
- ② - WFO - SEE NOTE FOR WFO, PAGE 4

SEARCHED	INDEXED
SERIALIZED	FILED
APR 20 1959	
[Redacted]	

Mr. E. Tomlin Bailey

Others named by [redacted] as being opposed to Castro and who may seek to harm him were [redacted]

b6  
b7C

[redacted] said he had learned Dominican and Cuban pickets were being sent in chartered busses from New York to Washington, D. C., to picket Castro. According to [redacted] this group of pickets would be paid \$50 per day and had been hired by [redacted] who is working with [redacted] New York City.

b6  
b7C

[redacted] said they had been told that one Brigadier General Francisco "Cillo" Tabernilla had hired persons to go to Washington, D. C., and New York City at the cost of \$100 per day for the purpose of picketing Castro.

Detective [redacted] of the New York City Police Department advised on April 14, 1959, that representatives of his Department on that date interviewed several occupants of a small apartment located at [redacted]

b6  
b7C

[redacted] He identified those interviewed as [redacted] Immigration and Naturalization Service (INS) Number [redacted] INS Number [redacted]

[redacted] a newspaper and television representative from Havana; [redacted] INS Number [redacted]

[redacted] INS Number [redacted]

[redacted] INS number [redacted]

who had no immigration documents in his possession.

Detective [redacted] said [redacted] acted as spokesman for the group and consented to a search of the apartment, which search disclosed no firearms. [redacted] told

Detective [redacted] he had no knowledge of a plot to kill Castro or of an organized demonstration planned against Castro. Detective [redacted] also advised the New York City Police Department on April 14, 1959, interviewed [redacted]

b6  
b7C

[redacted] sponsor of the above-mentioned six occupants of the apartment at [redacted] who denied he knew of plans for pickets to go to Washington, D. C., from New York City by bus.

Mr. E. Tomlin Bailey

[redacted]  
[redacted]  
[redacted] was also interviewed by the New York City Police Department on April 14, 1959, according to Detective [redacted] reportedly advised that three or four bus loads of Dominican sympathizers opposed to Castro will leave the headquarters of a pro-Trujillo organization, Morel Campos Social Club, 646 Jackson Avenue, Bronx, New York, at 7 a.m., April 17, 1959, for Washington, D. C., where they will picket Castro. [redacted] told the New York City Police Department that [redacted] a follower of Generalissimo Trujillo, will accompany the group to Washington, D. C.

b6  
b7C

Detective [redacted] further advised the New York City Police Department learned from [redacted] who was identified in the referenced letter from this Bureau as [redacted] on April 14, 1959, that representatives of Castro planned to meet with officials of the Polo Grounds in New York City on that date in an effort to make arrangements for use of the Polo Grounds for a celebration in honor of Castro planned for April 24, 1959.

b6  
b7C

Concerning Castro's itinerary after his visit to New York City, [redacted] advised on April 13, 1959, that the group plans to go to Cambridge, Massachusetts, from New York City and to then visit Montreal, Toronto and Ottawa, Canada, returning to Havana by direct flight from Ottawa. It was indicated that this itinerary is subject to change at any moment. Any additional pertinent information received by this Bureau will be furnished recipient agencies.

b6  
b7C

[redacted]

b3  
b7E

Mr. E. Tomlin Bailey

NOTE FOR SAC, WASHINGTON FIELD:

Re New York tel to Bureau and WFO, 4/14/59,  
11:22 p.m. Promptly furnish information concerning plans  
of pickets to come to Washington, D. C., on 4/17/59 to  
local police authorities.

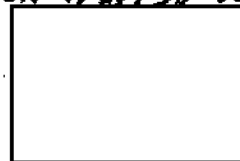

b6  
b7c

~~CONFIDENTIAL~~

April 16, 1959

FIDEL CASTRO

On April 16, 1959, a confidential source, who has furnished reliable information in the past, advised that

b3  
b7E

This memorandum is loaned to you by the Federal Bureau of Investigation and it is not to be distributed outside the agency to which loaned.

- 55- Bureau
- 1 - Houston
- 1 - New Orleans
- 1 - Miami
- ② - WFO

(10)

b3  
b6  
b7C  
b7E

~~CONFIDENTIAL~~

Searched   
Serialized   
Indexed   
Filed

b3  
b6  
b7C  
b7E



4/18/59

**AIRTEL**

**TO: DIRECTOR, FBI** [redacted]

b3  
b7E

**FROM: SAC, WFO** [redacted]

**FIDEL CASTRO**

[redacted]  
(OO:MM)

Attached hereto are five copies for the Bureau and one copy each for Houston, New Orleans, and Miami of a letter-head memo dated and captioned as above.

The information contained therein was furnished by [redacted]

b3  
b7E

Houston and New Orleans will be immediately advised of any additional info re CASTRO's visiting or not visiting these cities.

The attached memo is classified "~~Confidential~~" [redacted] and because the info contained therein might tend to identify an informant of continuing value and compromise the future effectiveness thereof.

b3  
b7E

*sent 4/18/59*

- 3 - Bureau (Encls.5)
- 1 - Houston (Encl.1)(Info)(RM)
- 1 - New Orleans (Encl.1)(Info)(RM)
- 1 - Miami (Encl.1)(Info)(RM)
- 2 - WFO

[redacted]

[redacted]

[redacted]  
(8)  
[redacted]

b3  
b6  
b7C  
b7E

**AIRTEL**

Searched [redacted]  
Serialized [redacted]  
Indexed [redacted]  
Filed [redacted]

b3  
b6  
b7C  
b7E

[redacted]

~~CONFIDENTIAL~~

April 18, 1959

FIDEL CASTRO

On April 17, 1959, a confidential source, who has furnished reliable information in the past, advised

[redacted]

b3  
b7E

[redacted]

b3  
b7E

On April 18, 1959, Captain [redacted] Special Services, Metropolitan Police Department, Washington, D. C., advised that [redacted]

b6  
b7C

[redacted] has purchased eight more .38 caliber pistols in Washington, D. C., bringing the number of such pistols he has purchased since the arrival of Fidel Castro to 27.

This memorandum is loaned to you by the Federal Bureau of Investigation, and neither it nor its contents are to be distributed outside the agency to which loaned.

- 5 - Bureau
- 1 - Boston
- 1 - Miami
- 1 - Newark
- 1 - New York
- ② - WFO [redacted]

(11)

Searched [redacted]  
Serialized [redacted]  
Indexed [redacted]  
Filed [redacted]

~~CONFIDENTIAL~~

b3  
b6  
b7C  
b7E

[redacted]

4/18/59

*Airtel*

TO: DIRECTOR, FBI [redacted]

b3  
b7E

FROM: SAC, WFO [redacted]

EIDEL CASTRO  
[redacted]

(OO:MM)

Attached hereto are five copies of a letterhead memo for the Bureau and one each for NY, NK, MM, and BS, for info, dated and captioned as above.

[redacted] The information contained therein was furnished by [redacted]

b3  
b7E

NY and NK will be immediately advised if any definite plans for CASTRO's appearance on the Barry Gray Show or his attendance at the Abyssinian Baptist Church are learned.

The information furnished by Captain [redacted] was furnished to SA [redacted]

b6  
b7C

The attached letterhead memo is classified "~~Confidential~~"

b3  
b7E

[redacted] and the information contained therein might tend to identify an informant of continuing value and compromise the future effectiveness thereof.

- 3 - Bureau (Encls. 5)
- 1 - Boston (Encl. 1) (Info) (RM)
- 1 - Miami (Encl. 1) (Info) (RM)
- 1 - Newark (Encl. 1) (INFO) (RM)
- 1 - New York (Encl. 1) (Info) (RM)

*sent 4/18/59*

② - WFO [redacted]

[redacted]  
(9)  
[redacted]  
[redacted]

[redacted]

b3  
b6  
b7C  
b7E

Searched [redacted]  
Serialized [redacted]  
Indexed [redacted]  
Filed [redacted]

AIRTEL

[redacted]

4/18/59

**AIRTEL**

**TO: DIRECTOR, FBI** [redacted]

**FROM: SAC, WFO** [redacted]

**FIDEL CASTRO**

[redacted]

b3  
b7E

ReNYairtel 4/17/59.

On the evening of 4/17/59, during reception held at Cuban Embassy. Detective [redacted] MPD, advised SA [redacted] a rumor was circulated that a hostile Dominican was in attendance at the reception. Cuban Embassy searched by [redacted] and CASTRO's security guard with negative results. No pickets were observed at the Embassy and no incidents occurred endangering CASTRO.

b6  
b7C

[redacted] advised CASTRO has personal body guards whom he described as "real hoodlums." Identified as [redacted] Have appearance of [redacted] with [redacted] being larger of two. Stated [redacted] while observing pickets at Statler Hotel, 4/17/59, desired to attack approximately 250 anti-CASTRO pickets. Was restrained by [redacted] since [redacted] was armed and stated he would take care of at least ten pickets before they got him.

b6  
b7C

- 3 - Bureau
- 1 - New York (Info) (RM)
- 1 - Miami (Info) (RM)
- 1 - WFO

[redacted]

[redacted]  
(6)

[redacted]

b6  
b7C

**AIRTEL**

Searched [redacted]  
 Serialized [redacted]  
 Indexed [redacted]  
 Filed [redacted]

b3  
b6  
b7C  
b7E

[redacted]

4/18/59

[redacted]

On 4/18/59, Captain [redacted] Special Services, MPD, advised CASTRO departed Cuban Embassy approximately 10:00 P. M. 4/17/59, rode to Haines Point, where he strolled for unknown period. Then returned to WDC where he appeared unannounced on STEVE ALLISON radio show. Returned to Embassy approximately 2:00 A. M., 4/18/59.

b3  
b6  
b7C  
b7E

[redacted] advised information received Cuban Embassy purchased on 4/17/59, an additional eight .38 caliber revolvers which brings total purchased to 27.

Informants contacted 4/17 and 18/59, advised no incidents have occurred against CASTRO since referenced airtel.

On 4/18/59, [redacted] in addition advised SA [redacted] that [redacted] [redacted] Desires informant to continue [redacted] 4/17/59,

b6  
b7C  
b7D

[redacted] desired following information be furnished to SA [redacted] of Miami Office:

b6  
b7C  
b7D

[redacted]

b3  
b7E



b7D

Information obtained of value to local authorities has been disseminated to them. Information obtained which would be of value to other government agencies submitted in form for dissemination.

Unless information of value obtained, a summary of activities for remainder of 4/18/59, and 4/19/59, will be submitted morning of 4/20/59.

# Office Memorandum • UNITED STATES GOVERNMENT

TO : SAC, WFO [redacted]

DATE: 4/20/59

b3  
b6  
b7C  
b7E

FROM : SA [redacted]

SUBJECT: FIDEL CASTRO

On the afternoon of 4/15/59, Supervisor [redacted] from the Bureau telephonically instructed that the following information be furnished to the various police agencies interested in CASTRO's visit to Washington, D. C.

b6  
b7C

We have received information from a source whose reliability is unknown that [redacted]

b6  
b7C  
b7D

[redacted]

SA [redacted] advised Detective [redacted] of the Metropolitan Police Department of the above.

b6  
b7C

SA [redacted] advised Lieutenant [redacted] of the Fairfax County Police and Captain [redacted] of the Park Police of the above.

At 4:49 p.m., 4/15/59, I informed Supervisor [redacted] of the Bureau that the aforementioned officers of the respective police departments had been informed of the above.

b6  
b7C

(1) - WFO

[redacted]

(1)

[redacted]

[redacted]	
SEARCHED [redacted]	INDEXED [redacted]
SERIALIZED [redacted]	FILED [redacted]
APR 20 1959	
FBI - WASH. F. O.	
[redacted]	

b3  
b6  
b7C  
b7E

UNITED STATES DEPARTMENT OF JUSTICE

FEDERAL BUREAU OF INVESTIGATION  
New York, New York

April 20, 1959

In Reply, Please Refer to  
File No.

Re: Fidel Castro

NY T-1 advised on April 15, 1959, that he  
has known Fidel Castro since 1945. [redacted]

NY T-1 stated that in 1945, when Fidel Castro  
began his law studies, Castro manifested a great desire  
to be the leader of the student body at the University  
of Havana. The informant stated that Castro has always  
had a consuming desire to be the most important individual  
in anything which he has undertaken. He also stated that  
Castro is the type of individual who would never let  
anything or anyone stand in his way of achieving his  
ultimate goal.

NY T-1 advised that [redacted]

b7D

b6  
b7C  
b7D

[redacted]

SEARCHED	INDEXED
SERIALIZED	FILED
APR 22 1959	

[redacted]

b3  
b6  
b7C  
b7E



NY T-1 further advised that during Castro's days at the University of Havana, Castro accepted and worked with the Communists who were in the University. The informant stated that it has never been definitely proven whether or not Castro was a member of the Communist Party, but it is a well-known fact that he has accepted aid from them and would use them in order to obtain his specific goals.

The informant also stated that [redacted]

[redacted]

b6  
b7C  
b7D

NY T-1 advised that while Fidel Castro was in the University of Havana, [redacted]

[redacted]

b6  
b7C  
b7D

NY T-1 advised that [redacted]

[redacted]

b6  
b7C  
b7D

[Redacted]

b6  
b7C  
b7D

Concerning the attack on the Moncada Barracks, which is in Santiago de Cuba, Cuba, the informant stated

[Redacted]

[Redacted] The informant stated that [Redacted]

b6  
b7C  
b7D

[Redacted]

The informant also stated that [Redacted]

[Redacted]

b7D

NY T-1 stated that Fidel Castro has always been an egotistical individual who has always sought power and

leadership and the type of individual who cannot stand any criticism of himself or his actions. The informant stated further that from his knowledge of Castro, Castro has never been a brave man and even during the fighting during the recent revolution, Fidel Castro did not engage in many skirmishes with the Cuban armed forces. The informant stated that Raul Castro and Major Ernesto "Che" Guevara, who are known and devoted Communists, have great influence over Fidel Castro.

NY T-1 also advised that it is quite evident in the new Cuban government how the Communists control many important posts and influence decisions of the new government. The informant stated that immediately after Batista fled Cuba on January 1, 1959, the Communist Party, which is well organized and disciplined in Cuba, emerged as a most important factor in the formation of Castro's government. The informant stated further that from individuals such as [redacted] and Ernesto Guevara, it is quite evident that the Cuban government, unless stopped, will be completely Communistic. NY T-1 stated that in addition to [redacted] and Ernesto Guevara, Castro has the following individuals close to him:

b6  
b7C

b6  
b7C  
b7D

Concerning the July 26th Movement, it is noted

that this movement was started by Fidel Castro when he made his abortive attack against the Moncada Barracks on July 26, 1953, from which his organization has taken its name.

This document contains neither recommendations nor conclusions of any kind. It is the property of the FBI, and is a loan to your agency; it and/or its contents are not to be distributed outside your agency.

UNITED STATES DEPARTMENT OF JUSTICE  
FEDERAL BUREAU OF INVESTIGATION  
New York, New York

In Reply, Please Refer to  
File No.

April 20, 1959

Re: Fidel Castro

Reference is made to New York memorandum dated and captioned as above.

NY -T-1, mentioned in attached memorandum, is an informant who was in a position to furnish reliable information but whose reliability has not yet been determined due to insufficient contact.

This document contains neither recommendations nor conclusions of any kind. It is the property of the FBI, and is a loan to your agency; it and/or its contents are not to be distributed outside your agency.

[Redacted]	
SEARCHED.....	INDEXED.....
SERIALIZED.....	FILED.....
APR 22 1959	
F. O. [Redacted]	



b3  
b6  
b7C  
b7E

4/20/59

AIRTEL

TO: DIRECTOR, FBI [redacted]  
 FROM: SAC, NEW YORK [redacted]  
 SUBJECT: FIDEL CASTRO  
 [redacted]

b3  
b7E

Enclosed herewith for the information of the Bureau are 11 copies of a letterhead memorandum and 11 copies of a reliability memorandum setting forth reliability of informant used.

NY T-1, mentioned in enclosed memorandum, is [redacted]

b7D

[redacted]

[redacted] was most cooperative during this interview on 4/15/59, and indicated his desire to cooperate with this Bureau in any way he could. A separate communication under the caption of [redacted] will be submitted requesting Bureau permission to recontact [redacted] as a potential security informant.

b7D

- 3 - Bureau [redacted] (Encls. 22) (RM)
- 1 - Miami (Encls. 2) (Info) (RM)
- ① - Washington Field (Encls. 2) (Info) (RM)
- 1 - New York [redacted]
- 1 - New York [redacted]

b3  
b6  
b7C  
b7E

[redacted]

(8)

[redacted]

SEARCHED [redacted] INDEXED [redacted]  
 SERIALIZED [redacted] FILED [redacted]

APR 22 1959

[redacted]

[Redacted]

b3  
b7E

Date: April 30, 1959

To: Mr. E. Tomlin Bailey  
Director  
Office of Security  
Department of State  
515 22nd Street, N. W.  
Washington 25, D. C.

From: John Edgar Hoover, Director  
Federal Bureau of Investigation

Subject: FIDEL CASTRO

[Redacted]

b3  
b7E

Reference is made to this Bureau's letter dated April 15, 1959, captioned as above.

A representative of the New York City Police Department advised our New York Office on April 17, 1959, that a group composed mostly of Dominican nationals left New York City in five Greyhound buses at 7:45 a.m., April 17, 1959, for Washington, D. C., where they planned to picket Fidel Castro. According to the New York City Police Department, more than one hundred individuals who planned to make the trip were left behind because there were not sufficient buses. [Redacted] was in charge of the pickets and reportedly told the New York City Police Department that they were being hired through the Dominican Consulate, New York City. The New York City Police Department also learned the pickets intended to return to New York City in the late evening of April 17, 1959.

b6  
b7C

The above confirms information furnished orally to [Redacted] in the office of [Redacted] Department of State, by Special Agent [Redacted] of this Bureau on April 17, 1959.

b6  
b7C

[Redacted]

b3  
b6  
b7C  
b7E

1 - Havana  
① - WFO

SEARCHED	INDEXED
SERIALIZED	FILED
MAY 19 1959	

[Redacted]

Mr. E. Tomlin Batley

b3  
b7E





April 17, 1959

**AIRTEL**

**To: SAC, San Antonio**

**From: Director, FBI**

**PIDEL CASTRO**  
[redacted]

b3  
b7E

"The San Antonio Express" for April 10, 1959, reported that Fidel Castro may go to San Antonio to witness its Fiesta San Jacinto celebration.

For the information of San Antonio, a New York source has learned that there is allegedly a definite plan to kill Castro when he comes to the United States. The source did not know where this attack would take place nor the identity of the participants.

Enclosed for San Antonio is a copy of Bulletin to State Department 4/9/59 together with two copies each of photographs of [redacted] and [redacted]

b6  
b7C

San Antonio will immediately furnish the information given by the New York source, the information in Bulletin to State Department 4/9/59, and one copy of each of the enclosed photographs to the local police. The same source who furnished the information in Bulletin to State 4/9/59 furnished the photographs.

Enclosures - 5

- 1 - Boston
- 1 - Miami
- 1 - Newark
- 1 - New York
- 1 - New Orleans
- 1 - Houston
- ① - Washington Field

b3  
b6  
b7C  
b7E

[redacted]

SEARCHED	INDEXED
SERIALIZED	FILED

APR 20 1959

[redacted]

**Airtel to San Antonio  
Re: Fidel Castro**

San Antonio should be alert for any data indicating subversives or anti-Castro demonstration may be fomented and any data indicating a threat to Castro's personal safety or that of his group. Sources and informants in a position to acquire this data should be alerted to the necessity for prompt reporting. The Bureau should be promptly advised of any pertinent data received and any indication of violence against Castro and members of his group should, in addition, be furnished local police authorities.

[Redacted]

b3  
b7E

Date: April 20, 1959

To: Mr. E. Tomlin Batley  
Director  
Office of Security  
Department of State  
515 22nd Street, N. W.  
Washington, D. C.

From: John Edgar Hoover, Director  
Federal Bureau of Investigation

Subject: FIDEL CASTRO

[Redacted]

b3  
b7E

This will confirm information furnished orally to [Redacted] of your Department by Special Agent [Redacted] of this Bureau on the morning of April 19, 1959.

b6  
b7C

On April 19, 1959, Charles Wain Dyer, Jr., Maple Lodge, 107 Fifth Street, Pulaski, Virginia, advised this Bureau as follows:

Dyer is a free-lance newspaperman who is not presently connected with any newspaper or syndicate. Earlier in 1959 he met a Cuban named [Redacted] when [Redacted] stopped in Pulaski, Virginia, to purchase gasoline. After talking to [Redacted] Dyer became interested in Fidel Castro and came to Washington, D. C., on the evening of April 16, 1959, to cover Castro's visit. He met one of Castro's bodyguards, [Redacted] on April 17, 1959, and was casually invited to the reception at the Cuban Embassy, Washington, D. C., on the night of April 17, 1959, by [Redacted]. Dyer appeared at the reception and was approved for admittance by [Redacted] of the Department of State. Dyer was able to speak briefly with Fidel Castro during the reception.

b6  
b7C

- 1 - Havana
- 2 - Richmond - See note page 2
- ② - WFO - See note page 2

[Redacted]

SEARCHED	INDEXED
SERIALIZED	FILED
APR 22 1959	
FBI - WASH. F.	

[Redacted]

b3  
b6  
b7C  
b7E

Mr. E. Tomlin Bailey

Dyer exhibited some handwritten notes which he had addressed to [redacted] who, according to Dyer, is residing at the Statler Hilton Hotel, Washington, D. C. One of the items indicated Dyer had overheard a "man connected with the Washington Police Department" say Castro was actually residing at the Statler Hilton Hotel and not the Cuban Embassy as newspapers have reported. This item indicated Castro was using a secret entrance at the hotel. In another item Dyer had written that he overheard a Washington, D. C., policeman state he had to go to New York to help protect Castro and this policeman was not happy. A third item concerned information to the effect that Dyer overheard a man who used the name [redacted] (or [redacted]) say over the telephone that he was going off duty and that Castro was probably already with "some woman" at that time.

b6  
b7C

Dyer said he wanted to check with the FBI and the Department of State concerning whether he should give the notes to [redacted]. He was advised the FBI could give him no advice in the matter. He said he planned to check with the Department of State at a later hour on April 19, 1959. The files of this Bureau contain no identifiable information concerning Dyer and we contemplate taking no further action concerning the material exhibited by Dyer.

b6  
b7C

Note to SACs, Richmond and WFO:

Dyer appeared at the Bureau at 5:55 a.m. 4/19/59. He carried identification papers showing he was born 4/22/15, Pulaski, Virginia, has Social Security Number 227-14-1886, Virginia Automobile Operator's Permit Number 716908 and owns a 1958 Chevrolet bearing Virginia License Number 833099. He said he is divorced. He had in his possession a letter from the Pulaski, Virginia, Police Department which indicated he is a legitimate writer and is in good standing with that Department. He claimed he had contributed articles to many southern newspapers within the past 2 years, including the Pulaski "Daily Times." Dyer denied he had been asked by [redacted] or any representative of the Cuban Government to report anti-Castro information to [redacted]. The provisions of the Foreign Agents Registration Act were cited to Dyer. Advise Bureau if information is received indicating Dyer is acting on behalf of the Cuban Government.

b6  
b7C

~~CONFIDENTIAL~~

b3  
b7E

Washington 25, D.C.  
April 20, 1959

FIDEL CASTRO

On April 17, 1959, a confidential informant,  
who has furnished reliable information in the past,  
advised [redacted]

[redacted]

b3  
b7E

The informant also advised that [redacted]

[redacted]

b3  
b7E

According to the informant, [redacted]

[redacted]

b3  
b7E

The informant also advised that [redacted]

[redacted]

b3  
b7E

5-Bureau [redacted]

②-WFO [redacted]

[redacted]

(7) [redacted]

[redacted]

b3  
b6  
b7C  
b7E

Searched [redacted]  
Serialized [redacted]  
Indexed [redacted]  
Filed [redacted]

~~CONFIDENTIAL~~

~~CONFIDENTIAL~~

Re: FIDEL CASTRO

~~CONFIDENTIAL~~

On April 18, 1959, the informant advised that

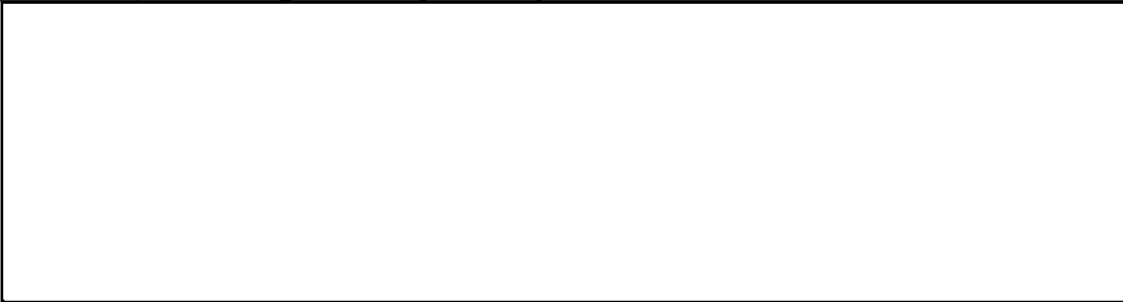

b3  
b6  
b7C  
b7E

This memorandum is loaned to you by the Federal Bureau of Investigation and neither it nor its contents are to be distributed outside the agency to which loaned.

~~CONFIDENTIAL~~

4/20/59

AIRTEL

TO: DIRECTOR, FBI [redacted]

b3  
b7E

FROM: SAC, WFO [redacted]

FIDEL CASTRO

[redacted]

Enclosed for the Bureau are five copies of a letterhead memo dated 4/20/59.

The information in enclosed letterhead memo was furnished by [redacted] on 4/17/59.

b3  
b7E

The enclosed memo is classified "~~confidential~~"

[redacted]

[redacted] and since the data reported could reasonably result in identification of a confidential informant of continuing value and compromise the future effectiveness thereof.

2-Bureau (Encls. 5) *sent 4/20*  
2-WFO

[redacted]

[redacted]

(5) [redacted]

[redacted]

b3  
b6  
b7C  
b7E

AIRTEL

Searched [redacted]  
Serialized [redacted]  
Indexed [redacted]  
Filed [redacted]

b3  
b6  
b7C  
b7E

[redacted]

April 20, 1959

AIRTEL

TO: DIRECTOR, FBI [redacted]

FROM: SAC, WFO [redacted]

b3  
b7E

FIDEL CASTRO RUZ  
[redacted]

Remyairtel 4/18/59.

Diplomatic reception held as scheduled Cuban Embassy 4/18/59. No incidents occurred.

At 1:30 A.M. 4/19/59 CASTRO, accompanied by four CASTRO followers, State Security guards and Metropolitan Police Department (MPD) officers, departed Cuban Embassy by rear door and travelled to 1816 M Street, N. W., Washington, D. C. CASTRO stayed in this building until approximately 5:00 A.M., at which time he returned to Cuban Embassy. This address is old residence which has been converted to some office space and some apartments. State Security men and MPD officers believed from conversation of CASTRO followers that CASTRO at above address with female companion per previous arrangements.

At approximately 1:55 A.M. [redacted] advised

b3  
b6  
b7C  
b7E

[redacted]

- 3 - Bureau
- 1 - Miami (Info)(RM)
- 1 - Newark (Info)(RM)
- 1 - New York (Info)(RM)
- (1) - WFO

[redacted]  
(7) [redacted]

A I R T E L

[redacted] *[Handwritten signature]*

Searched \_\_\_\_\_  
 Serialized [redacted]  
 Indexed \_\_\_\_\_  
 Filed [redacted]

b3  
b6  
b7C  
b7E

[redacted]



[redacted]

b3  
b6  
b7C  
b7E

[redacted]

[redacted] advised Special Agent [redacted]  
[redacted] 4/20/59 that [redacted]

b6  
b7C  
b7D

[redacted] No listing with [redacted] Washington,  
D. C., telephone and address telephone directories for  
[redacted]

No record WFO indices for [redacted]  
[redacted] In view of above information, no additional  
investigation to be conducted re these persons by WFO.

b6  
b7C

At 9:40 A.M. CASTRO departed Washington, D. C.,  
for Mount Vernon and returned at 11:45 A.M. He visited  
Lincoln Memorial and Jefferson Memorial, returning to Cuban  
Embassy approximately 12:30 P.M.

He departed Cuban Embassy approximately 5:00 P.M.  
with [redacted] thereafter appearing on "Meet the Press".  
At conclusion this program he went directly to Capitol Building,  
arriving approximately 7:00 P.M. He conferred with Vice  
President RICHARD M. NIXON until 9:30 P.M. and returned  
Cuban Embassy approximately 9:45 P.M. No incidents concerning  
CASTRO on 4/19/59.

b6  
b7C

[redacted] advised Special Agent [redacted]  
[redacted]

b6  
b7C  
b7D

Special Agent [redacted]  
[redacted] and noted that neither MPD or State Security  
was aware of this. Immediately told MPD and State Security

b6  
b7C  
b7E

[redacted]

b3  
b6  
b7C  
b7E

men that an anti-CASTRO man whom Special Agent [redacted] had observed in picket lines had entered Cuban Embassy. Security men entered Embassy with MPD and stated they had found informant in a "back room" surrounded by CASTRO bodyguards. Bodyguards indicated they would "take care" of [redacted] but Security men insisted he be released since would work to disadvantage of Cuban Government. [redacted] was escorted from building and proceeded south on 16th Street. [redacted]

[redacted] who desired to attack approximately 250 anti-CASTRO pickets on 4/17/59, left Embassy and started after [redacted] and indicated he was going to shoot him. Was physically restrained by fellow Cubans, thereby avoiding incident.

Captain [redacted] MPD, advised he was made aware of the above situation by his detectives and has stated that he will not allow [redacted]

b6  
b7C  
b7E

[redacted] in vicinity of National Press Club 4/20/59 since [redacted] fears Cuban followers will attempt to create incident concerning both [redacted]

In view of above, WFO feels [redacted]

[redacted]

b6  
b7C  
b7D  
b7E

On 4/19/59 Captain [redacted] telephonically advised that [redacted] advised [redacted] that one busload of anti-CASTRO pickets would depart New York City and arrive Washington, D. C., approximately 11:00 A.M. 4/20/59. [redacted] plans to keep this group completely separated from any pro-CASTRO pickets which should appear at subject's appearance at National Press Club this date. It is noted that [redacted] has told [redacted]

b6  
b7C  
b7D

[redacted]

CASTRO still scheduled to leave Washington, D. C., 4:00 P.M. by Pennsylvania Railroad for Princeton, New Jersey.



b3  
b7E

*Close liaison being maintained with local authorities and information of value being furnished them on current basis.*

*Bureau will be advised of future developments.*

April 20, 1959

AIRTEL

TO: DIRECTOR, FBI [redacted]  
FROM: SAC, WFO [redacted]

b3  
b7E

EDEL CASTRO RUZ  
[redacted]

Re my airtel 4/20/59.

CASTRO visited Arlington Cemetery this A.M.; attended luncheon National Press Club. Fifty tickets from New York City, led by [redacted] arrived Washington, D. C., by bus; departed approximately 2:15 P.M. for New York City.

b6  
b7C

CASTRO and party of approximately 35 departed Union Station, Washington, D. C., 4:02 P.M. 4/20/59 aboard Pennsylvania Railroad Train 152, the Afternoon Congressional. Party occupying last two cars on train. Train to make special stop Princeton, New Jersey, arriving 6:50 P.M.

Unverified information from [redacted] indicates [redacted]

b3  
b7E

- 3 - Bureau
- 1 - Boston (Info)(RM)
- 1 - Miami (Info)(RM)
- 1 - Newark (Info)(RM)
- 1 - New York (Info)(RM)
- 1 - WFO

b6  
b7C

(8) [redacted]

A I R T E L

Inspector [redacted] office telephonically advised of CASTRO's departure 4:15 P.M. by SA [redacted]

[redacted]

b3  
b6  
b7C  
b7E

Searched \_\_\_\_\_  
Serialized \_\_\_\_\_  
Indexed \_\_\_\_\_  
Filed \_\_\_\_\_

[redacted]

b3  
b7E

[redacted]

For info other offices, only possible incidents  
Washington, D. C., involved activities of [redacted]

[redacted] who is hot-head and desired  
to attack 250 anti-CASTRO pickets on 4/17/59 and attempted  
to chase and possibly shoot [redacted]

b6  
b7C  
b7E

[redacted] has restrained physically  
on both occasions.

[redacted] advised

[redacted]

b6  
b7C  
b7D

CASTRO party is accompanied by following men  
from Security Office, State Department, Washington, D. C.:

[redacted]

b6  
b7C

CASTRO tentatively to depart Princeton, New Jersey,  
9:50 A.M. 4/21/59 and arrive New York City 4/21/59 at  
10:45 A.M.

Newark and New York Office cognizant of above.

No incidents Washington, D. C. Info of interest  
to other Government agencies will be submitted in form  
suitable for dissemination.

4/21/59

AIRTEL

Registered Mail

TO: DIRECTOR, FBI [redacted]  
 FROM: SAC, NEWARK [redacted]  
 SUBJECT: FIDEL CASTRO  
 [redacted]

b3  
b7E

Re WFO airtel to Bureau dated 4/20/59.

CASTRO arrived Princeton, NJ, aboard Pennsylvania Railroad 6:52 PM, 4/20/59, and escorted by NJSP to home of [redacted] Princeton, NJ, where he was to be a guest.

b6  
b7C

At approximately 8:15 PM, CASTRO arrived Woodrow Wilson Hall, Princeton University, for scheduled speech. Upon arrival was greeted by enthusiastic and unruly crowd of college students, approximately 1,000 in number, who attempted to engulf the official party prior to their entry into the building. NJSP opened a lane to the door of the building and all members of the official party were able to enter building. No incidents were noted and no injuries received by anyone in official party. CASTRO spoke approximately two hours, then departed from building by back door. He objected to this procedure and insisted that he be driven to front of building where approximately 200 students had gathered so that he might speak to them. He spoke to these students for approximately five minutes, then was escorted to the residence of Governor MEYNER of New Jersey.

CASTRO arrived at Governor MEYNER's residence shortly after 10 PM and attended an informal reception. Noted at this reception were DEAN LACHESON, former Secretary of State, and [redacted] Princeton University, as well as Governor and Mrs. MEYNER. He departed from Governor's residence approximately 11:30 PM and spent night in guest house of [redacted]

b6  
b7C

- 3 - Bureau
- 1 - New York (Info)
- ① - WFO (Info)
- 1 - Newark

[redacted]  
 (6)

[redacted]

SEARCHED [redacted] INDEXED [redacted]  
 SERIALIZED [redacted] FILED [redacted]

APR 22 1959

FBI - NEWARK

[redacted]

b3  
b6  
b7C  
b7E

[REDACTED]

b3  
b7E

On 4/21/59, CASTRO spoke to students at Lawrenceville Prep School, Lawrenceville, NJ, approximately 20 minutes, then departed for Pennsylvania Railroad station, Princeton Junction, NJ. Boarded Pennsylvania Railroad train, Princeton Junction, NJ, 9:50 AM, due to arrive 10:45 AM, NYC.

Major [REDACTED] NJSP Headquarters, Trenton, NJ, was kept advised of all pertinent information of value in this matter. Also, liaison was maintained with local police departments and State Department personnel.

b6  
b7C

No incidents of any kind occurred during visit to Princeton, NJ.

Letterhead memorandum to follow.

4/21/59

**Airtel**

**To: SAC, Miami**

**From: Director, FBI** [redacted]

**Subject: EIDEL CASTRO**  
[redacted]

b3  
b7E

ReWFO airtel 4/18/59 advising [redacted] desired  
certain information furnished to SA [redacted] of Miami Office.

b6  
b7C  
b7D

Subairtel identity of [redacted]  
[redacted] and advise what  
investigation is being conducted concerning him by your office.

1 - New York  
① - WFO [redacted]

b3  
b7E

b3  
b6  
b7C  
b7E

[redacted]

SEARCHED	INDEXED
SERIALIZED	FILED
APR 21 1959	
F. O. [redacted]	

[redacted]



April 21, 1959

ANTI-FIDEL CASTRO ACTIVITIES

On April 14, 1959, a source of information whose reliability is not known, but who has a wide acquaintance among Latin-Americans in Washington, D. C., furnished the following information:

The informant stated

[Redacted]

b6  
b7C  
b7D

The informant stated that on Sunday, April 11, 1959,

[Redacted]

b6  
b7C  
b7D

Searched \_\_\_\_\_  
Serialized \_\_\_\_\_  
Indexed \_\_\_\_\_  
Filed \_\_\_\_\_

[Redacted]

b3  
b6  
b7C  
b7E

[Redacted]

**RE: ANTI-FIDEL CASTRO ACTIVITIES**

[REDACTED]

b6  
b7C  
b7D

**On April 19, 1959,** [REDACTED]

[REDACTED]

b6  
b7C  
b7D

**On April 21, 1959, the same source of information advised that [REDACTED] on the previous day. He learned that [REDACTED]**

b6  
b7C  
b7D

[REDACTED]

**This memorandum is loaned to you by the Federal Bureau of Investigation, and neither it nor its contents are to be distributed outside the agency to which loaned.**

4/21/59

**AIRTEL**

**TO: DIRECTOR, FBI** [redacted]

b3  
b7E

**FROM: SAC, WFO** [redacted]

**ANTI-PIDEL CASTRO ACTIVITIES**

[redacted]

There are attached for the Bureau five copies, for Miami one copy, and for NY two copies of a letterhead memo reflecting info received from [redacted] (PSI) who furnished info contained in WFO airtel 4/15/59 and also furnished info to WFO on 4/21/59.

b6  
b7C  
b7D

[redacted] indicated he intended to [redacted] and thereafter would advise WFO of any info obtained.

- 3 - Bureau (Encls. 5)
- 1 - Miami (Encl. 1)(Info)(RM)
- 2 - New York (Encls. 2)(Info)(RM)
- ② - WFO [redacted] (CASTRO)

b3  
b6  
b7C  
b7E

[redacted]  
(9)

[redacted]

**AIRTEL**

Searched [redacted]  
 Serialized [redacted]  
 Indexed [redacted]  
 Filed [redacted]

b3  
b6  
b7C  
b7E

[redacted]

4/22/59

**AIRTEL**

**TO :** DIRECTOR, FBI [redacted]  
**FROM:** SAC, NEW YORK [redacted]  
WIDEL CASTRO  
[redacted]

b3  
b7E

Detective [redacted] BSS, NYCPD, advised on 4/21/59 that CASTRO and his party arrived in Penn Station at approximately 11:07 A.M. and was greeted by an unruly crowd of approximately 20,000 people. [redacted] advised that, upon his arrival in New York, he immediately went to his hotel suite at the Statler Hotel, which is in Room 1710-1712A. [redacted] advised that CASTRO then proceeded in the afternoon to Columbia University where he addressed a student group and was at the "New York Times" for a meeting with editors of the "Times" which began at approximately 3:30 P.M.

b6  
b7C

[redacted]

b6  
b7C  
b7D

- 3 - Bureau [redacted] (RM)
- 1 - Boston (RM) (INFO)
- 1 - Miami (RM) (INFO)
- ① - Washington Field (RM) (INFO)
- 1 - New York [redacted]

b3  
b7E

[redacted]  
(8)

b3  
b6  
b7C  
b7E

[redacted]
SEARCHED [redacted] INDEXED [redacted]
SERIALIZED [redacted] FILED [redacted]
APR 23 1959
[redacted]

[Redacted]

b3  
b7E

[Redacted]

b6  
b7C  
b7D  
b7E

[Redacted]

student  
LIFE, City College of New York, advised 4/22/56 that FIDEL  
CASTRO will speak on 4/25/56 at City College from 9:00 A.M.  
to 12 noon in John H. Findlay Student Center, 130th Street  
and Convent Avenue, NYC.

b6  
b7C

The above information will not be submitted in a  
form suitable for dissemination because [Redacted]

[Redacted]

b7D  
b7E

[Redacted]

*and the source could be compromised UACB.*

C

Director, FBI [redacted]

April 14, 1959

Legat, Havana [redacted]

FIDEL ALEJANDRO CASTRO RUZ  
[redacted]

b3  
b7E

Re Havana letter dated April 10, 1959.

Concerning FIDEL CASTRO's proposed trip to the United States, the Embassy has been unable to obtain from the Cuban Foreign Office a list of individuals who will accompany CASTRO and his complete itinerary. This office through [redacted] sources has been able to identify the following persons as some of those who will accompany CASTRO. This, however, is by no means a complete list as it is reported that approximately 90 persons will be with CASTRO on his trip which will be taken via a chartered Cubana "Britannia" airliner. In addition to [redacted] mentioned in relet, the following will also accompany CASTRO:

b3  
b6  
b7C  
b7E

[Large redacted area]

b6  
b7C

Extra copies of this letter have been prepared for forwarding by the Bureau to the New York and Washington Field offices.

6 - Bureau (2-cc: New York and WFO)  
1 - Havana

[redacted]

(7)

[redacted]
SEARCHED [redacted] INDEXED [redacted]
SERIALIZED [redacted] FILE [redacted]
APR 23 1959
[redacted]

b3  
b6  
b7C  
b7E

Date \_\_\_\_\_

SAC: WFO \_\_\_\_\_ Field Office

Re: \_\_\_\_\_

The enclosed is for your information. If used in a future report  conceal all sources,  paraphrase contents.

Enclosed are corrected pages from report of SA \_\_\_\_\_ dated \_\_\_\_\_

For information.

For appropriate action.

Remarks:

1. 2

Enclosure(s)

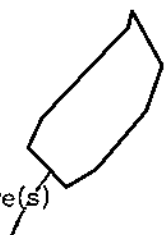

SEARCHED		INDEXED	
SERIALIZED		FILED	
APR 23 1959			

b3  
b6  
b7C  
b7E



UNITED STATES DEPARTMENT OF JUSTICE  
FEDERAL BUREAU OF INVESTIGATION

In Reply, Please Refer to  
File No.

WASHINGTON 25, D. C.

April 23, 1959

FIDEL CASTRO

The Confidential Informant, mentioned in the letterhead memorandum is in a position to comment about Cuban activities; however, he has not been contacted a sufficient number of times to evaluate his reliability.

This memorandum is loaned to you by the Federal Bureau of Investigation, and neither it nor its contents are to be distributed outside the agency to which loaned.

- 5 - Bureau [redacted]
- 1 - Miami (Info) (RM)
- 1 - New York (Info) (RM)
- 2 - WFO [redacted]

b3  
b6  
b7C  
b7D  
b7E

[redacted]

(9)

[redacted]

93

Searched  
Serialized  
Indexed  
Filed

[redacted]

b6  
b7C



~~CONFIDENTIAL~~

b6  
b7C



UNITED STATES DEPARTMENT OF JUSTICE  
FEDERAL BUREAU OF INVESTIGATION

WASHINGTON 25, D. C.

In Reply, Please Refer to  
File No.

April 23, 1959

FIDEL CASTRO

On April 15, 1959, a Confidential Informant contacted a Special Agent of the Federal Bureau of Investigation, Washington, D.C., and advised that

b7D

On April 16, 1959, the informant advised that

b6  
b7C  
b7D

On April 17, 1959, the informant advised

b7D

- 5 - Bureau
- 1 - Miami (Info) (RM)
- 1 - New York (Info) (RM)
- ② - WFO
- (1 -

b3  
b6  
b7C  
b7D  
b7E

*WFO copy*

(9)

Searched

Serialized

Indexed

Filed

~~CONFIDENTIAL~~

~~JAN 17 1960~~

**FIDEL CASTRO**

On April 18, 1959, the informant advised [redacted]

b7D

[redacted]

On April 20, 1959, the informant mentioned that

[redacted]

b6  
b7C  
b7D

The informant also stated that [redacted]

[redacted]

The informant concluded by stating that [redacted]

b6  
b7C  
b7D

[redacted]

This memorandum is loaned to you by the Federal Bureau of Investigation and neither it nor its contents are to be distributed outside the agency to which loaned.

~~JAN 17 1960~~

4/23/59

**AIRTEL**

**TO: DIRECTOR, FBI** [redacted]

b3  
b7E

**FROM: SAC, WFO** [redacted]

**FIDEL CASTRO**  
[redacted]

Enclosed are five copies for the Bureau, one to Miami, and one to New York, for information, of a letterhead memo and an equal number of letterhead memos evaluating the informant mentioned therein, dated 4/23/59.

The information in enclosed memo was furnished by [redacted] a PSI of WFO, to SA [redacted] on the dates indicated.

b6  
b7C  
b7D

The enclosed memo is classified "~~Confidential~~"

[redacted] and since data reported could reasonably result in the identification of a Confidential Informant of continuing value and compromise the future effectiveness thereof.

b3  
b7E

- 3 - Bureau (Encls. 10)
- 1 - Miami (Encls. 2) (Info) (RM)
- 1 - New York (Encls. 2) (Info) (RM)
- ② - WFO

*Not 4-22*

[redacted]  
[redacted]  
[redacted]  
(7) [redacted]

b3  
b6  
b7C  
b7D  
b7E

Searched [redacted]  
Serialized [redacted]  
Indexed [redacted]  
Filed [redacted]

b3  
b6  
b7C  
b7E

[redacted]

~~CONFIDENTIAL~~

April 24, 1959

FIDEL CASTRO

On April 24, 1959, a confidential informant, whose reliability is not known but who has a wide acquaintance among Latin American individuals in Washington, D.C., furnished the following information:



b6  
b7C  
b7D

This memorandum is loaned to you by the Federal Bureau of Investigation and neither it nor its contents are to be distributed outside the agency to which loaned.

- 5- Bureau
- 2- New York
- 1- Boston (Info)
- 1- Miami (Info)
- 2- WFO

(11)

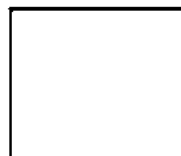

b3  
b6  
b7C  
b7D  
b7E

~~CONFIDENTIAL~~

Searched

Serialized

Indexed

Filed

b3  
b6  
b7C  
b7E

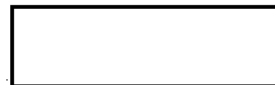

4/24/59

**AIRTEL**

**TO: DIRECTOR, FBI**

**FROM: SAC, WFO** [redacted]

b3  
b7E

**FIDEL CASTRO**  
[redacted]

Attached for the Bureau are five copies, for New York two copies, and one copy each for Boston and Miami of a letterhead memorandum reflecting information received from [redacted] PSI. [redacted] is attempting to obtain additional information regarding this matter and will advise WFO.

b6  
b7C  
b7D

New York advised telephonically and requested, along with Boston, to advise local PDS.

Attached memorandum is classified "~~Confidential~~"

[redacted]

b3  
b7E

- 3- Bureau (Encls. 5)
- 2- New York (Encls. 2)
- 1- Boston (Encl. 1)(Info)
- 1- Miami (Encl. 1)(Info)
- 2- WFO

*sent 4/24/59. RM*

[redacted]

(9)

[redacted]

b3  
b6  
b7C  
b7D  
b7E

[redacted]

Searched [redacted]  
Serialized [redacted]  
Indexed [redacted]  
Filed [redacted]

b3  
b6  
b7C  
b7E

[redacted]

4/22/59

PLAIN TEXT

AIRTEL

AIR MAIL

TO: DIRECTOR, FBI  
FROM: SAC, SAN ANTONIO [redacted]  
RE: FIDEL CASTRO  
[redacted]

b3  
b7E

Re Bureau airtel to San Antonio dated 4/17/59.

On 4/20/59, [redacted]

b6  
b7C

[redacted] advised SAC L. ELAYLOCK that FIDEL CASTRO, Prime Minister of Cuba has been invited by the San Antonio Press Club to come to San Antonio for the Fiesta Week beginning 4/20/59. [redacted] stated that it is very doubtful that CASTRO will be able to visit San Antonio due to his schedule, however, CASTRO might possibly make a quick visit to San Antonio at the end of the Fiesta Week 4/25/59. [redacted] reiterated that it is very doubtful CASTRO will make such a visit to San Antonio.

Captain [redacted] (NA), was furnished information in referenced airtel and information contained in enclosed letter from Director to Office of Security, Department of State dated 4/9/59. Captain [redacted] was also furnished two copies of photographs received.

b6  
b7C

Logical informants in this matter were also alerted.

The Bureau will be immediately advised of any further developments.

- 3 - Bureau
- 1 - Houston (Info)
- 1 - Washington Field (Info)
- 1 - San Antonio

(6)

b3  
b6  
b7C  
b7E

AIR TEL

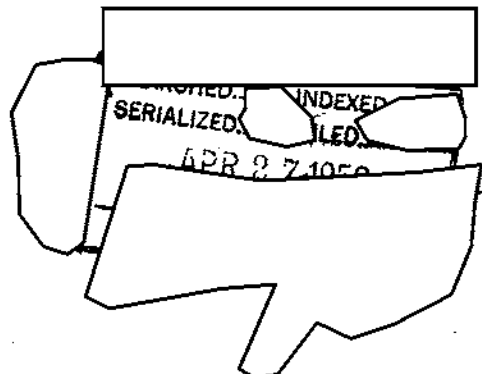



b3  
b7E

Copies of this airtel are being furnished to  
Houston and Washington Field for informational purposes.

- RUC -

END

BLAYLOCK

4/23/59

**AIRTEL**

**TO :** DIRECTOR, FBI [redacted]

**FROM:** SAC, NEW YORK [redacted]

**FIDEL CASTRO**  
[redacted]

On 4/23/59, CASTRO, during A.M., visited Mayor WAGNER at City Hall and thereafter attended luncheon of Overseas Press Club at Sheraton Astor Hotel. CASTRO is scheduled to speak at 5:30 P.M., 4/23/59 at Council on Foreign Relations, 58 East 68th Street, NYC.

On 4/24/59, CASTRO will speak at 8:30 P.M. at Central Park Mall. NYCPD will employ 1,000 patrolmen and 300 detectives in maintaining security precautions.

On 4/25/59, CASTRO will depart at 11:00 A.M. for Boston from Pennsylvania Railroad Station, utilizing the three rear cars, possibly on Train #188. He will arrive Back Bay Station, 3:35 P.M., and will stay at Sheraton Plaza Hotel. At 6:25 P.M., this date, he will attend a cocktail and dinner party at Faculty Club, Quincy Street, Massachusetts. Three hundred people are expected to attend. At 8:15 P.M., CASTRO will speak at Dillen Field House, Harvard University, before six to ten thousand people. At 11:00 P.M., he will return to Faculty Club for reception prior to return to hotel.

- 3- Bureau [redacted] (RM)
- 1- Boston (INFO)(RM)
- 2- New Haven (INFO)(RM)
- ① Washington Field (INFO)(RM)
- 1- New York [redacted]

[redacted]

(8)

b3  
b7E

b3  
b6  
b7C  
b7E

[redacted]

SEARCHED	INDEXED
SERIALIZED	FILED
APR 27 1959	

[redacted]



[Redacted]

On 4/25/59, CASTRO will depart Logan Airport at 10:00 A.M. via Canadian Air Force plane. Arrangements being handled by [Redacted] CASTRO expects to cut short his Canadian visit as he is scheduled to be in Havana no later than 5/1/59. While in New York, CASTRO has been in the company of [Redacted] who is from Havana.

b3  
b6  
b7C  
b7E

The above information furnished through police liaison. There has been a rumor that CASTRO may check off to Connecticut during the night of 4/23/59, and NYCPD cognizant, attempting to check this matter out and contemplating alerting Connecticut State Police and town police where necessary.

No incidents occurred during CASTRO'S visit on 4/23/59. Above furnished for information of interested offices.

# Office Memorandum • UNITED STATES GOVERNMENT

TO : SAC, Washington Field

DATE: April 28, 1959

FROM : Director, FBI [redacted]

b3  
b7E

SUBJECT: FIDEL CASTRO  
[redacted]

In connection with numerous communications submitted by your office as an outgrowth of subject's recent visit to Washington, D. C., under the caption of this letter as well as under the captions "Anti-Fidel Castro Activities" and [redacted] it is noted that in many instances these communications and the letterhead memoranda enclosed with them have made reference to various individuals and organizations which are of interest to New York and Miami, in some cases subjects of pending investigations by those offices. For example, a number of references are contained in these communications regarding [redacted] at [redacted] both New York City and Miami.

b3  
b6  
b7C  
b7E

New York and Miami should carefully review all of the communications submitted by WFO in connection with subject's recent visit to Washington, D. C., to insure that, where warranted, pertinent data regarding subjects of other investigations is appropriately reported under the individual case caption involved.

Particular reference is directed to WFO airtel 4/15/59 captioned [redacted] with enclosure, which contains information to the effect that [redacted] was apparently endeavoring to obtain financial assistance from one [redacted] of NYC. This individual may be identical with [redacted] NYC. WFO and New York should be particularly alert for any indication that [redacted] [redacted] are furnishing support for anti-Castro activities, financial or otherwise. If such information should be received, the Bureau should be promptly advised and consideration should be given to requesting the Bureau to obtain clearance for active investigation [redacted].

b3  
b6  
b7C  
b7E

- 2 - Miami
- 2 - New York

[redacted]  
SEARCHED \_\_\_\_\_ INDEXED \_\_\_\_\_  
SERIALIZED \_\_\_\_\_ FILED \_\_\_\_\_  
APR 29 1959  
[redacted]

b3  
b6  
b7C  
b7E

4-24-59

PLAIN TEXT

AIRTEL

AIR MAIL

TO: DIRECTOR, FBI  
FROM: SAC, CLEVELAND [redacted]  
RE: DR. FIDEL CASTRO  
[redacted]

b3  
b7E

Re Cleveland letter of 4-21-59, captioned as above.

Additional review of Cleveland Office files disclosed a matter entitled, [redacted], in which Washington Field is the office of origin and in which the Bufile is [redacted]

b3  
b6  
b7C  
b7E

In the Washington Field case mention is made of the meeting between [redacted] at Toledo, Ohio, wherein [redacted] was offering eleven planes described as possibly being C-74s.

b6  
b7C

Cleveland Office inquiry at Toledo, Ohio in March, 1959, in response to a Washington Field lead in the [redacted] matter developed information relative to [redacted]. It was learned that [redacted] was acting as a representative of the Akros Dynamics Corporation of Cleveland, owner of eleven Douglas C-74 type aircraft.

b6  
b7C

The Akros Dynamics Corporation was said to be an investment firm located at 1810 Terminal Tower, Cleveland, and the principal officers of the firm are [redacted] all of Cleveland, Ohio. It was said that all of the planes were purchased from the government by this firm as an investment for lease or resale.

b6  
b7C

It was said that the sale of the planes to the UAR did not go through because approval of the sale could not be obtained from the State Department.

3-Bureau  
2-Cincinnati  
2-Cleveland [redacted]

(7)

[redacted]	
SEARCHED [redacted]	INDEXED [redacted]
SERIALIZED [redacted]	FILED [redacted]
APR 30 1959	
[redacted]	

b3  
b6  
b7C  
b7E



b3  
b7E

The Cincinnati Office at Columbus, Ohio, is requested to make discreet inquiry at the office of the Ohio Secretary of State for complete information on the corporate origin and setup of the Akros Dynamics Corporation, 1810 Terminal Tower, Cleveland, Ohio, the partial officership of which is set out hereinbefore. It is believed this corporation was formed in early 1958.

The Cincinnati Office will advise the Bureau of the results of their inquiry under the caption of this letter and will also make the information available to the Cleveland Office.

Director, FBI

4-21-59

SAC, Cleveland

[Redacted]

b3  
b7E

DR. FIDEL CASTRO

[Redacted]

Prior to departing for Miami Beach, Florida, for a vacation of approximately one month in that city and subsequently in the Tampa, Fla. area, [Redacted] on 4/15,16/59, furnished the following information:

b7D

[Redacted]

b6  
b7C  
b7D

[Redacted]

b6  
b7C  
b7D

[Redacted]

2-Bureau  
2-Cleveland

[Redacted]

[Redacted]

(4)

COPY

[Redacted]

SERIALIZED	INDEXED
FILED	
APR 20 1959	

[Redacted]

b3  
b6  
b7C  
b7D  
b7E

b3  
b7E

[Redacted]

[Redacted]

b6  
b7C  
b7D

On 4-16-59, the informant said [Redacted]

[Redacted]

b6  
b7C  
b7D

[Redacted] He will furnish any subsequent information he obtains regarding this matter.

The informant confidentially advised that [Redacted]

[Redacted]

b6  
b7C  
b7D  
b7E

[Redacted]

b6  
b7C  
b7D

[redacted]

b3  
b7E

[redacted]

b6  
b7C  
b7D

[redacted]

No information identifiable with [redacted] was found in the Cleveland Office indices, but there is information in file [redacted]

[redacted] of Condonna Uranium Mines Limited. Shares in this company were sold by a director of the company to several Toledo citizens who suspected that the company might not be wholly legitimate. The matter was referred to the Bureau under date of 6-24-58, under caption, "[redacted]"

b6  
b7C

[redacted]

The Cleveland Office indices make reference to one [redacted] described by informants as [redacted] According to informants, [redacted]

b6  
b7C  
b7D

[redacted]

Upon receipt of additional information relative to this matter from Confidential Informant [redacted] the Bureau will be immediately advised.

b7D

Date \_\_\_\_\_

4-29-59

SAC: WFO

Legal Attache: \_\_\_\_\_

Re:

b3  
b6  
b7C  
b7E

The enclosed is for your information. If used in a future report  conceal all sources,  paraphrase contents.

Enclosed are corrected pages from report of SA \_\_\_\_\_ dated \_\_\_\_\_

For information.

For appropriate action.

Remarks:

Enclosure(s) 

SEARCHED \_\_\_\_\_ INDEXED \_\_\_\_\_  
SERIALIZED \_\_\_\_\_ FILED \_\_\_\_\_

APR 30 1959

b3  
b6  
b7C  
b7E



April 30, 1959

CODE

RADIOGRAM

URGENT

TO SAC SAN JUAN

FROM DIRECTOR FBI [REDACTED]

FIDEL CASTRO, [REDACTED]

REURRAD APRIL TWO NINE

LAST CAPTIONED QUOTE [REDACTED]

UNQUOTE.

AUTHORITY GRANTED ORALLY FURNISH INFO [REDACTED]

[REDACTED] SAN JUAN. WFO ADVISED BY MAIL.

① - WASHINGTON FIELD

b3  
b7D  
b7E

[REDACTED]

SEARCHED [ ] INDEXED [ ]  
SERIALIZED [ ] FILED [ ]

APR 30 5 21 PM '59

[REDACTED]

b3  
b6  
b7C  
b7E

[REDACTED]

[REDACTED]



~~CONFIDENTIAL~~  
UNITED STATES DEPARTMENT OF JUSTICE

FEDERAL BUREAU OF INVESTIGATION

In Reply, Please Refer to  
File No.

Newark, New Jersey  
May 5, 1959

FIDEL CASTRO

On April 21, 1959, Major [redacted] New Jersey State Police, West Trenton, New Jersey, furnished the following information concerning Castro's visit to Princeton, New Jersey on April 20, 1959, and April 21, 1959.

b6  
b7C

He advised that Castro, the Prime Minister of Cuba, arrived at Princeton Junction, New Jersey, at 6:52 p.m. on April 20, 1959 aboard a Pennsylvania Railroad train. He was greeted there by approximately 100 persons and was immediately taken to the home of his host, [redacted] a professor at Rutgers University who resides in Princeton, New Jersey. He remained at the residence of [redacted] until a few minutes before 8:00 p.m., at which time he and members of his party motored to the Woodrow Wilson School of Public and International Affairs at Princeton University, Princeton, New Jersey. Upon his arrival at the Woodrow Wilson School, he was greeted by a group of students estimated to number approximately 1,000, and when this crowd recognized Castro, they became very enthusiastic and unruly, and attempted to crowd around his official party.

b6  
b7C

The students broke through police lines set up around the Castro party and it was extremely difficult for the members of the official party to gain admittance to the Woodrow Wilson School, and it was necessary for the State Police officers to physically restrain the crowd in order to allow the members of the official party to enter the building.

There were no incidents of any kind during this greeting, and it was characterized by Major [redacted] as a typical college greeting.

b3  
b6  
b7C  
b7E

Castro addressed the group of approximately 200 persons, primarily students of the Woodrow Wilson School, for approximately two hours and during his address there were no incidents of any kind. Upon the completion of his address

SEARCHED \_\_\_\_\_ INDEXED \_\_\_\_\_  
SERIALIZED \_\_\_\_\_ FILED \_\_\_\_\_  
MAY 11 1959  
FBI - NEWARK  
[redacted]

~~CONFIDENTIAL~~

~~CONFIDENTIAL~~

FIDEL CASTRO

he was escorted out the rear entrance of the building; however, he insisted upon being returned to the front of the building in order that he might address a group of approximately 200 students who had remained at the front entrance, awaiting his exit from the building. Upon his insistence, he was returned to the front of the building, where he gave an impromptu speech for approximately ten minutes.

He was then escorted to the residence of Governor Meyser of New Jersey in Princeton, New Jersey, where he was entertained at an informal reception. At the Governor's residence, he met with United States Senator Joseph Clark of Pennsylvania and former United States Secretary of State Dean Acheson, as well as personnel of the faculty of Princeton University.

He departed from the Governor's residence at approximately midnight and immediately returned to the residence of his host, [redacted] where he remained for the night.

b6  
b7c

On the morning of April 21, 1959, he gave a short informal talk to the students of the Lawrenceville Preparatory School, Lawrenceville, New Jersey, and upon departing from there, he journeyed directly to the Pennsylvania Railroad Station, Princeton Junction, New Jersey. He boarded a Pennsylvania Railroad train at 9:50 a.m. en route to New York City, and was scheduled to arrive there at 10:45 a.m.

Major [redacted] advised that during his entire visit to Princeton, New Jersey, there were no incidents of any kind.

b6  
b7c

This document contains neither recommendations nor conclusions of any kind. It is the property of the Federal Bureau of Investigation, and is a loan to your agency; it and/or its contents are not to be distributed outside your agency.

~~CONFIDENTIAL~~

# Office Memorandum • UNITED STATES GOVERNMENT

TO : DIRECTOR, FBI [redacted]

DATE: 5/5/59

FROM : SAC, NEWARK [redacted]

SUBJECT: FIDEL CASTRO  
[redacted]

b3  
b7E

Re Newark airtel to Bureau dated 4/24/59.

Enclosed herewith are five copies for the Bureau, and one copy for Washington Field, of a letterhead memorandum dated and captioned as above.

The attached letterhead memorandum is classified ~~confidential~~ [redacted]

b3  
b7E

[redacted]

During CASTRO's visit to Princeton, New Jersey, Bureau agents maintained liaison with personnel of the New Jersey State Police, the Princeton, New Jersey Police Department, and the Lawrenceville Police Department, as well as security personnel of the U. S. State Department.

All information of value was furnished to the above listed departments and they in turn advised that they would furnish any information of interest to the Bureau. It is to be noted that at no time during CASTRO's visit to Princeton, New Jersey, did he or any member of his official party become involved in any incidents of any type. His visit to Princeton, New Jersey, was scheduled and his activities while in Princeton, New Jersey, were limited to this schedule.

One copy of this letterhead memorandum is being furnished to the Washington Field Office inasmuch as that office has a continuing interest in this matter.

There is no additional investigation to be conducted in the Newark Division in this matter. - RUC

b6  
b7c

- 2 - Bureau (ENCL.5) REG.MAIL
- 1 - WFO (ENCL.1) REG.MAIL
- 1 - Newark [redacted]

(4)

- 104

SEARCHED	INDEXED
SERIAL [redacted]	FILED [redacted]
MAY 5 1959	
[redacted]	[redacted]

~~CONFIDENTIAL~~

b6  
b7C

~~CONFIDENTIAL~~

May 15, 1959

FIDEL CASTRO

On May 14, 1959, a confidential informant, who has furnished reliable information in the past, [redacted]

[Large redacted block]

b3  
b6  
b7C  
b7E

This memorandum is loaned to you by the Federal Bureau of Investigation, and neither it nor its contents are to be distributed outside the agency to which loaned.

- 3 - Bureau [redacted]
- ② - WFO [redacted]
- (1 - [redacted])

[redacted]  
(5)

b3  
b6  
b7C  
b7E

20

Searched [redacted]  
Serialized [redacted]  
Indexed [redacted]  
Filed [redacted]

b3  
b6  
b7C  
b7E

~~CONFIDENTIAL~~

[redacted]

5/15/69

**AIRTEL**

**TO: DIRECTOR, FBI** [redacted]

b3  
b7E

**FROM: SAC, WFO** [redacted]

**FIDEL CASTRO**  
[redacted]

Attached for the Bureau are five copies of a letterhead memo dated and captioned as above. The information was furnished by [redacted]

b3  
b7E

Attached memo was classified ~~confidential~~ [redacted]

[redacted] and the information could result in the identification of an informant of continuing value and jeopardize future effectiveness thereof.

3 - Bureau (Encls. 5)

② - WFO  
[redacted]

b3  
b6  
b7C  
b7E

[redacted]

(5)

*AD*



b3  
b6  
b7C  
b7E

Searched \_\_\_\_\_  
Serialized \_\_\_\_\_  
Indexed \_\_\_\_\_  
Filed \_\_\_\_\_  
[redacted]

**AIRTEL**

[redacted]

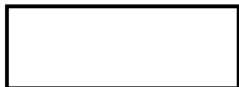

DIRECTOR, FBI 

5-28-59

b3  
b6  
b7C  
b7E



SAC, WFO 



FIDEL CASTRO

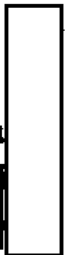

ReBuairtel to WFO dated 4-7-59.

A review of the file revealed that all pertinent information has been furnished the Bureau and interested offices. Since FIDEL CASTRO has returned to Cuba this file will be placed in a closed status.

2 Bureau  
1 WFO  
(3)  
  
  

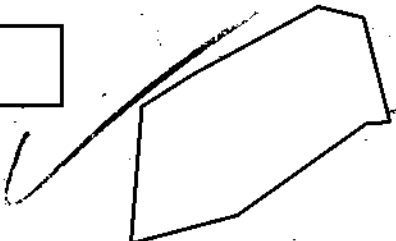

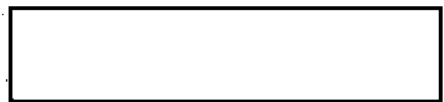
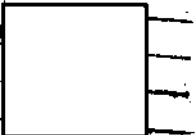

b3  
b6  
b7C  
b7E

Searched  
Serialized  
Indexed



Part



C

SEARCHED	INDEXED
SERIALIZED	FILED

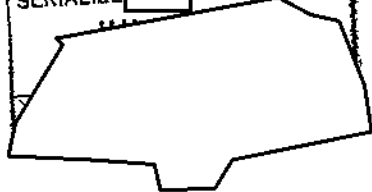

b3  
b6  
b7C  
b7E



Date JUL 23 1959

TO SAC:

- Albany
- Albuquerque
- Anchorage
- Atlanta
- Baltimore
- Birmingham
- Boston
- Buffalo
- Butte
- Charlotte
- Chicago
- Cincinnati
- Cleveland
- Dallas
- Denver
- Detroit
- El Paso

- Honolulu
- Houston
- Indianapolis
- Jacksonville
- Kansas City
- Knoxville
- Little Rock
- Los Angeles
- Louisville
- Memphis
- Miami
- Milwaukee
- Minneapolis
- Mobile
- Newark
- New Haven

- New Orleans
- New York City
- Norfolk
- Oklahoma City
- Omaha
- Philadelphia
- Phoenix
- Pittsburgh
- Portland
- Richmond
- St. Louis
- Salt Lake City
- San Antonio
- San Diego
- San Francisco
- San Juan

- Savannah
- Seattle
- Springfield
- Washington Field
- Quantico

TO LEGAT:

- Bonn
- Havana
- London
- Madrid
- Mexico D. F.
- Ottawa
- Paris
- Rome
- Rio de Janeiro
- Tokyo

RE:

For information

For appropriate action

The enclosed is for your information. If used in a future report,  conceal all sources,  paraphrase contents.

Enclosed are corrected pages from report of SA \_\_\_\_\_ dated \_\_\_\_\_

REMARKS:

Enclosure



SEARCHED	INDEXED
SERIALIZED	FILED
JUL 24 1959	

b3  
b6  
b7C  
b7E

~~CONFIDENTIAL~~

~~CONFIDENTIAL~~

b6  
b7C

September 25, 1959

FIDEL CASTRO

The confidential informant mentioned in the letterhead memorandum dated and captioned as above has furnished reliable information in the past.

This memorandum contains neither recommendations nor conclusions of the Federal Bureau of Investigation. It is the property of the Federal Bureau of Investigation and is loaned to your agency; it and its contents are not to be distributed outside your agency.

- 4 -- Bureau [redacted]
- ④ -- WFO [redacted]

b3  
b6  
b7C  
b7D  
b7E

- [redacted]
- ⑧ [redacted]

*W*

~~CONFIDENTIAL~~

~~CONFIDENTIAL~~

[redacted]

Searched [redacted]

Serialized [redacted]

Indexed [redacted]

Filed [redacted]

b3  
b6  
b7C  
b7E

~~CONFIDENTIAL~~

September 25, 1959

FIDEL CASTRO

A confidential informant advised on September 24, 1959, that he learned that [redacted]

[redacted]

b6  
b7C  
b7D

On September 25, 1959, the informant advised that [redacted]

[redacted]

The informant stated that [redacted]

[redacted]

b6  
b7C  
b7D

The informant advised that [redacted]

[redacted]

4 - Bureau [redacted]

④ - Washington Field [redacted]

[redacted]

b3  
b6  
b7C  
b7D  
b7E

[redacted]

(8)

[redacted]

*MD*

[redacted]

Searched [redacted]  
Serialized [redacted]  
Indexed [redacted]  
Filed [redacted]

~~CONFIDENTIAL~~

~~CONFIDENTIAL~~

Re: Fidel Castro

Concerning the Cuban situation, the informant  
learned from

b6  
b7C  
b7D

[Redacted]

Informant also learned

b6  
b7C  
b7D

[Redacted]

This memorandum contains neither recommendations nor conclusions of the Federal Bureau of Investigation. It is the property of the Federal Bureau of Investigation and is a loan to your agency; it and its contents are not to be distributed outside your agency.

~~CONFIDENTIAL~~

C

9/25/59

**AIRTEL**

**TO: DIRECTOR, FBI** [redacted]

b3  
b7E

**FROM: SAC, WFO** [redacted]

**FIDEL CASTRO**  
[redacted]

Enclosed are four copies of a letterhead memo and an equal amount of letterhead memos evaluating the informant mentioned therein dated and captioned as above.

The information in enclosed letterhead memo was furnished by [redacted] to SA [redacted] on 9/24 and 25/59.

b6  
b7C  
b7D

The source advised on 9/25/59, that [redacted]

[redacted]

Source stated he will furnish this office all information he receives [redacted]

[redacted]

4 - Bureau (Encls. 4) sent 9/25/59.  
2 - WFO

[redacted]

[redacted]  
(8) [redacted]

b3  
b6  
b7C  
b7D  
b7E

W

**AIRTEL**

Searched [redacted]  
Serialized [redacted]  
Indexed [redacted]  
Filed [redacted]

[redacted]

b3  
b6  
b7C  
b7E

ok  
LO

[redacted]

The Bureau is aware that [redacted]  
[redacted] who furnished reliable information [redacted]

[redacted]

The letterhead memos are classified "~~confidential~~"

[redacted]

[redacted] and since the data reported could  
reasonably result in identification of a confidential  
informant of continuing value and compromise the future  
effectiveness thereof.

DIRECTOR, FBI [redacted]

10/12/59

b3  
b6  
b7C  
b7E

SAC, WFO [redacted]

[redacted]

Re telephone call from Inspector [redacted]  
of Bureau to WFO 10/1/59.

On 10/1/59, [redacted]

b6  
b7C

[redacted] United Fruit Company, Room 605, 1511 K Street, N. W.,

WDC, was interviewed by SA [redacted] advised that his duties primarily involve liaison work with government officials in WDC. [redacted] advised that on 9/26/59, he was telephonically contacted by [redacted]

[redacted] an attorney having offices in the Cafritz Building. [redacted] indicated that he would like to discuss a situation with [redacted] and would also like to bring an individual who [redacted] might be interested in. [redacted] stated that he had never heard of or seen [redacted] prior to this contact. However, he agreed to see [redacted] on the afternoon of 9/26/59. [redacted] arrived in the office of [redacted] accompanied by subject. [redacted] stated that he believed subject might have information of interest to [redacted]

b6  
b7C

After Subject, who described himself as an "international trouble shooter", informed [redacted] that he was a close personal friend of FIDEL CASTRO, present head of the Cuban Government. Subject also indicated that he was very well acquainted with all of the members of the current Cuban staff or Government. Subject stated that he was aware of the information which has been given considerable public press notice that there was a strong possibility that CASTRO would expropriate all of the land of the United Fruit Company in Cuba as well as any other private industry. Subject stated ~~he~~ believed that he could be of considerable help to the United Fruit Company to prevent this situation developing and that by just a few words to CASTRO and his assistants subject would be able to avoid such confiscation.

b6  
b7C

2-Bureau

②-WFO

① - [redacted] (CASTRO)

20

[redacted]

b3  
b6  
b7C  
b7E

[redacted]  
Searched [redacted]  
Serialized [redacted]  
Indexed [redacted]  
Filed [redacted]

(4)

[redacted]

b3  
b7E

Subject stated that he operated the concern known as Global Services which headquartered in Miami, Fla. He also stated that he had helped many U. S. concerns in connection with difficulties in various foreign countries. In this connection he stated that he had been most helpful to Pan American Airways in various countries served by this concern. [redacted] contact, according to subject, was [redacted]

b6  
b7C

[redacted] of Pan American Airways.

Subject then asked [redacted] if he believed the United Fruit Company would be interested in utilizing his services.

[redacted] stated that he had no idea as to whether consideration would be given to this matter but that he would forward the information furnished by subject to the president of United Fruit Company in Boston, Mass., for any consideration he might desire to give it. [redacted] also informed the subject that if their concern should become interested in utilizing the services of subject he would be advised and could proceed to Boston, Mass., for interview with other company officials. Subject and [redacted] then departed and [redacted] has heard nothing further from them since the above date. [redacted] stated that at no time during the contact with subject was there any indication or inference that subject was employed or connected with the Cuban Government or any other foreign government as an agent.

b6  
b7C

[redacted] advised that at the beginning of the interview with subject and [redacted] he informed them that he would accept any statements they desired to make but that no action would be taken personally by him and the matter merely furnished to his superiors. [redacted]

b3  
b6  
b7C  
b7E

[redacted]

[redacted] was advised that the files of the FBI are confidential and that no information whatsoever re subject could be furnished to him. He stated that he was aware of this situation having had various contacts with the Bureau in the past, but that he believed



[redacted]

b3  
b7E

the Bureau would be interested in the information furnished by subject and that in the event of any further contact he would again advise the WFO. [redacted] stated that he intends to make additional inquiries concerning the possible merit, as well as the background of subject. In this connection, a vice president of the United Fruit Company, who headquarters in NYC, has contacted [redacted] Pan American Airways who informed the United Fruit Company official that he was acquainted with subject and considered him a "remarkable man".

b6  
b7C

As the Bureau is aware, WFO has maintained contact with [redacted] intermittently over the past 2 or 3 years re subject's activities. Efforts to establish a violation of the Registration Act have been unsuccessful. In the absence of additional information indicating a possible violation of the Registration Act or other matters coming within the Bureau's jurisdiction, no further action re this matter is contemplated at this time. However, in the event additional information is received from [redacted] or other sources, the Bureau will be immediately advised.

b6  
b7C

b6  
b7C

~~CONFIDENTIAL~~

[redacted]

b3  
b7E

**Date:** December 8, 1959  
**To:** Office of Security  
Department of State  
**From:** John Edgar Hoover, Director  
**Subject:** [redacted]

~~Handwritten signature~~

b3  
b7E

A source who is in a position to furnish reliable information advised [redacted]

[Large redacted block]

b6  
b7C  
b7D

The above is furnished for your information.

[Large redacted block]

b3  
b6  
b7C  
b7E

SEARCHED [ ] INDEXED [ ]  
SERIALIZED [ ] FILED [ ]  
DEC 9 1959  
FBI [ ]

- ① - WFO
- 1 - New York
- 1 - Miami
- 1 - Legat, Havana

~~CONFIDENTIAL~~

[redacted]

~~CONFIDENTIAL~~



b3  
b6  
b7C  
b7E



~~CONFIDENTIAL~~

January 11, 1960

**AIRTEL**

**TO: SAC, MIAMI**

**FROM: DIRECTOR, FBI**

**FIDEL CASTRO**

b3  
b7E

**All offices receiving this communication should immediately advise the Bureau in the event any information is received indicating Castro plans to visit the United States.**

- 1 - New York
- ① - WFO
- 1 - Havana
- 1 - Atlanta

*1/11/60*

SEARCHED	<span style="border: 1px solid black; display: inline-block; width: 80%; height: 100%;"></span>	<span style="border: 1px solid black; display: inline-block; width: 80%; height: 100%;"></span>
SERIALIZED	<span style="border: 1px solid black; display: inline-block; width: 80%; height: 100%;"></span>	<span style="border: 1px solid black; display: inline-block; width: 80%; height: 100%;"></span>

**JAN 11 1960**

b3  
b6  
b7C  
b7E

UNITED STATES GOVERNMENT

# Memorandum

TO : SAC, WFO

DATE: June 16, 1960

FROM : Director, FBI

[Redacted]

b3  
b7E

SUBJECT: FIDEL CASTRO

[Redacted]

[Redacted]

*Pull*

b6  
b7C  
b7E

On 6/3/60

(protect).

[Large redacted block]

You should contact [Redacted] and endeavor to verify the foregoing information. If the information is true, you should submit the information in letterhead memorandum form suitable for dissemination.

b6  
b7C  
b7D  
b7E

On 6/10/60

[Redacted] advised that

[Redacted] is the

[Redacted block]

[Redacted] In the event [Redacted] contacts your office, you should accept any information he volunteers and furnish your observations and recommendations as to his potential as a PSI. No record of [Redacted] was located in Bufiles.

b3  
b6  
b7C  
b7E

*Review & advise [Redacted] 6/16/60*

SEARCHED	INDEXED
SERIALIZED	FILED
JUN 17 1960	
FBI - WASH. F. O.	

7

DIRECTOR, FBI [redacted]

7/29/60

b3  
b7E

SAC, WFO [redacted]

FIDEL CASTRO  
[redacted]

ReBulet to WFO dated 6/16/60, captioned as above.

On 7/11 and 7/26/60, [redacted] was contacted by SA [redacted] concerning an indication that the informant

b6  
b7C  
b7D

[redacted]

For information of the Bureau, the informant advised that [redacted]

[redacted]

b7D

WEC  
2-Bureau  
2-WFO

[redacted]

[redacted]

(4)

*close*  
*116*

b3  
b6  
b7C  
b7D  
b7E

Searched \_\_\_\_\_  
Serialized \_\_\_\_\_  
[unclear] \_\_\_\_\_  
[unclear] \_\_\_\_\_

8/19/60

PLAIN TEXT

AIRTEL

TO: DIRECTOR, FBI [redacted]

FROM: SAC, NEW YORK [redacted]

SUBJECT: FIDEL CASTRO RUZ  
[redacted]

b3  
b7E

Re Miami airtel, 8/2/60, requesting NYO to attempt to locate [redacted] and interview him concerning FIDEL CASTRO's physical condition.

b6  
b7C

Miami PSI indicated [redacted] was known to the staff of the hospital, specializing in cancer, located on the east side of First Avenue, NYC. This is probably Memorial Center for Cancer and Allied Diseases, 444 East 68th Street.

On 8/18/60, [redacted] Memorial Center, advised that the Center includes Memorial Hospital, Sloan-Kettering Research Institute and James Ewing Institute. There is a total of 3,000 medical doctors and research scientists attached thereto.

b6  
b7C

[redacted] caused a check of the records to be made and there was no record of [redacted]

[redacted] advised that one [redacted] a medical doctor formerly of Havana, Cuba, applied for a position with the Center, 8/17/60, and might be acquainted with [redacted]

b6  
b7C

RUC.

3-Bureau [redacted] (RM)  
 2-Miami [redacted] (RM)  
 ①-Washington Field (Info) (RM)  
 1-New York [redacted]

b3  
b6  
b7C  
b7E

(9)

SEARCHED	INDEXED
SERIALIZED	FILED
AUG 22 1960	
FBI - WASH. F. O.	

Ⓟ

[redacted]

[redacted] advised on 8/19/60, that she departed Havana 8/5/60, and flew directly to NYC. She said that [redacted] is a prominent general surgeon in Havana; however, she is not personally acquainted with him.

[redacted] said that she had heard that [redacted] had left Cuba; however, she knows nothing about his present whereabouts. She said she would notify the NYC if she receives any information relative to [redacted] whereabouts.

During the conversation with [redacted], it was pointed out that the press has carried several stories relative to CASTRO's health and her opinion was requested.

[redacted] said that she has no first hand knowledge about CASTRO's physical condition; however, there is much speculation in Cuban medical circles regarding his illness.

[redacted] said she is of the opinion that CASTRO's recent illness was an attack of lobal pneumonia.

The NYC contemplates no further active investigation to attempt to locate [redacted] unless Miami receives further information regarding his presence in NYC.



~~CONFIDENTIAL~~ b6  
b7C

September 14, 1990

**RAEL CASTRO RUIZ**  
[redacted]

b3  
b7E

On September 13, 1990, a confidential informant, who has furnished reliable information in the past, advised

[redacted]

b3  
b6  
b7C  
b7E

On September 14, 1990, the same confidential informant learned from [redacted]

[redacted]

b3  
b6  
b7C  
b7E

- 9- Bureau [redacted]
- 1- Miami [redacted]
- 1- Newark [redacted]
- 1- New York [redacted]
- ② WFO [redacted]

[redacted]

Searched [redacted]  
Serialized [redacted]  
Indexed [redacted]  
Filed [redacted]

b3  
b6  
b7C  
b7E

~~CONFIDENTIAL~~

9/14/60

**AIRTEL**

**TO:** DIRECTOR, FBI [redacted]  
**FROM:** SAC, WFO [redacted]  
**SUBJECT:** FIDEL CASTRO RUM  
[redacted]

b3  
b7E

Enclosed for the information of the Bureau are nine copies of a letterhead memorandum dated and captioned as above, reflecting information received from [redacted]. One such information copies are also designated for New York and Newark in view of CASTRO's projected visit to the New York area to attend the upcoming United Nations session. One information copy is also designated for Miami in view of their continuing interest in Cuban matters.

b3  
b7E

In connection with [redacted] in the enclosed letterhead memorandum that [redacted]

[Large redacted block]

b3  
b6  
b7C  
b7E

- 3- Bureau (Enc. 9)
- 1- Miami [redacted] (Enc. 1) (Info) (RM)
- 1- Newark [redacted] (Enc. 1) (Info) (RM)
- 1- New York [redacted] (Enc. 1) (Info) (RM)
- 2- WFO

*Info 9-14*

b3  
b6  
b7C  
b7E

(9)

[redacted]

Searched \_\_\_\_\_  
Serialized \_\_\_\_\_  
Indexed \_\_\_\_\_  
Filed \_\_\_\_\_

b3  
b6  
b7C  
b7E

[redacted]

b3  
b7E

In the event the above information from [redacted] is disseminated in the future, it should be classified "~~Secret~~" due to the sensitive nature of the source. In the event of downgrading, it should be classified "~~Confidential~~" [redacted]

b3  
b7E

[redacted] and the information could result in the identification of an informant of continuing value and compromise the future effectiveness thereof.

The attached letterhead memorandum is classified "~~Confidential~~" [redacted]

b3  
b7E

[redacted] and the information could result in the identification of an informant of continuing value and compromise the future effectiveness thereof.

~~CONFIDENTIAL~~

September 15, 1960

FIDEL CASTRO RUEZ  
[redacted]

b3  
b7E

A confidential informant, who is in a position to have knowledge of [redacted] advised a Special Agent of the Federal Bureau of Investigation on September 15, 1960, that [redacted]

b7D

According to the informant, [redacted]

b7D

[redacted]

This document contains neither recommendations nor conclusions of the FBI. It is the property of the FBI and is loaned to your agency; it and its contents are not to be distributed outside your agency.

- 9-Bureau [redacted]
- 1-New York [redacted]
- 2-WFO [redacted]
- [redacted]
- [redacted]

b3  
b6  
b7C  
b7D  
b7E

[redacted]

[redacted]

b3  
b6  
b7C  
b7E

SEARCHED [redacted]  
SERIALIZED [redacted]  
INDEXED [redacted]  
FILED [redacted]

~~CONFIDENTIAL~~



~~CONFIDENTIAL~~  
UNITED STATES DEPARTMENT OF JUSTICE  
FEDERAL BUREAU OF INVESTIGATION

In Reply, Please Refer to  
File No.

Washington, D. C.  
September 15, 1960

Title **FIDEL CASTRO RUIZ**

Character [redacted]

b3  
b7E

Reference **Memorandum dated and captioned as  
above at Washington, D. C.**

All sources (except any listed below) used in referenced  
communication have furnished reliable information in the past.

The confidential informant mentioned has been  
contacted an insufficient number of times to judge his  
reliability, but is in a position to have accurate knowledge  
of [redacted]

- 9-Bureau [redacted]
- 1-New York [redacted]
- (2)-WFO [redacted]
- [redacted]
- [redacted]

(12)

b3  
b6  
b7C  
b7D  
b7E



9/15/60

**AIRTEL**

**TO: DIRECTOR, FBI** [redacted]

b3  
b7E

**FROM: SAC, WFO** [redacted]

**FIDEL CASTRO RUX**  
[redacted]

There are being forwarded herewith for the Bureau and New York, copies of a letterhead memo and accompanying memo evaluating the source of the information set forth therein. The source furnishing the information was [redacted]. She furnished this information to SA [redacted].

b6  
b7C  
b7D

The attached letterhead memorandum and its accompanying memorandum evaluating source have been classified "Confidential" [redacted], and in addition the contents could possibly lead to disclosure of a potentially productive confidential informant.

b3  
b7E

- 3-Bureau (Encls. 9)
- 1-New York [redacted] (Encl. 1) (Info) (RM)
- 2-WFO

b3  
b6  
b7C  
b7D  
b7E

(6)

**AIRTEL**

*See copies delivered by Special Messenger 9-15-60*



[redacted]

Searched \_\_\_\_\_

Serialized \_\_\_\_\_

Indexed \_\_\_\_\_

Filed \_\_\_\_\_

b3  
b6  
b7C  
b7E



UNITED STATES DEPARTMENT OF JUSTICE  
FEDERAL BUREAU OF INVESTIGATION

~~CONFIDENTIAL~~

In Reply, Please Refer to  
File No.

Washington 25, D. C.  
September 15, 1960

FIDEL CASTRO RUZ  
[redacted]

b3  
b7E

A confidential informant who has furnished reliable information in the past, has advised that on September 14,

[redacted]

b3  
b7E

Later on September 14, 1960, the same informant advised he had learned [redacted]

[redacted]

b3  
b6  
b7C  
b7E

- 9 - Bureau [redacted]
- 1 - Miami [redacted] (Info) (RM)
- 1 - Newark [redacted] (Info) (RM)
- 1 - New York [redacted] (Info) (RM)

[redacted]

Searched [redacted]  
Serialized [redacted]  
Indexed [redacted]  
Filed [redacted]

b3  
b6  
b7C  
b7E

2 - WFO [redacted]  
1 - [redacted]

(14) [redacted]

[redacted]

~~CONFIDENTIAL~~

~~CONFIDENTIAL~~

FIDEL CASTRO RUZ



b3  
b6  
b7C  
b7E

The "Members of Permanent Missions To The United Nations Entitled To Diplomatic Privileges and Immunities" for July, 1960, reflects that Dr. Manuel Bisbe is Ambassador and Permanent Representative to the United Nations for Cuba.

The "Diplomatic List" for June, 1960, published by the USDS, reflects that [redacted] is

b6  
b7C

This document contains neither recommendations nor conclusions of the FBI. It is the property of the FBI and is loaned to your agency; it and its contents are not to be distributed outside your agency.

~~CONFIDENTIAL~~



9/15/60

AIRTEL

TO: DIRECTOR, FBI [redacted]

FROM: SAC, WFO [redacted]

FIDEL CASTRO RUZ  
[redacted]

b3  
b7E

ReWFOairtel to Director, 9/14/60, captioned as above.

Enclosed for the Bureau are nine copies of a letterhead memo dated and captioned as above reflecting information received from [redacted]

b3  
b7E

Information copies are also designated for New York and Newark in view of FIDEL CASTRO's possible attendance with other Cuban delegates at the forthcoming United Nations session at New York City.

An information copy is designated for Miami in view of their continuing interest in Cuban matters.

The attached letterhead memo is classified "~~Confidential~~" [redacted] and the information could result in identification of an informant of continuing value and compromise future effectiveness thereof.

b3  
b7E

- 3- Bureau (Enc. 9)
- 1- Miami [redacted] (Enc. 1)(Info)(RM)
- 1- Newark [redacted] (Enc. 1)(Info)(RM)
- 1- New York [redacted] (Enc. 1)(Info)(RM)
- 2- WFO

b3  
b6  
b7C  
b7E

(8)

AIRTEL

[redacted]

Searched \_\_\_\_\_

Serialized [redacted]

Indexed \_\_\_\_\_

Filed [redacted]

~~CONFIDENTIAL~~

b6  
b7C

February 23, 1961

FIDEL CASTRO RUC

[redacted]

On February 22, 1961, an informant, who has furnished reliable information in the past, advised [redacted]

b3  
b6  
b7C  
b7E

[redacted]

Prensa Latina is a Latin American News Service with headquarters in Havana, Cuba.

RUC

- 9 - Bureau [redacted]
- 1 - Miami [redacted] (Info) (RM)
- 1 - New York (Info) (RM)
- 2 - WFO [redacted]

b3  
b6  
b7C  
b7E

[redacted]

(13)

[redacted]

[redacted]

[redacted]

Searched \_\_\_\_\_  
 Serialized \_\_\_\_\_  
 Indexed \_\_\_\_\_  
 Filed \_\_\_\_\_

b3  
b6  
b7C  
b7E

This document contains neither recommendations nor conclusions of the FBI. It is the property of the FBI and is loaned to your agency; it and its contents are not to be distributed outside your agency.

~~CONFIDENTIAL~~

2/23/61

**AIRTEL**

**TO: DIRECTOR, FBI** [redacted]

b3  
b7E

**FROM: SAC, WFO** [redacted]

**FIDEL CASTRO RUZ**  
[redacted]

**(OO:MM)**

Enclosed herewith are nine copies to the Bureau, and one each to Miami and New York for information of a letterhead memo dated and captioned as above.

The informant referred to in the enclosed letterhead memo is [redacted]

b3  
b7E

The enclosed letterhead memo is classified "~~Confidential~~" [redacted] and the information could result in the identification of an informant of continuing value and compromise the future effectiveness thereof.

**EUC**

- 3 - Bureau (Encs - 9)
- 1 - Miami [redacted] (Info) (RM) (Encs - 1)
- 1 - New York (Info) (RM) (Encs - 1)
- 2 - WFO

b3  
b6  
b7C  
b7E

*Handwritten:*  
2-23-61

[redacted]  
[redacted] (7)  
[redacted]

**AIRTEL**

Searched	[redacted]
Serialized	[redacted]
Indexed	[redacted]
Filed	[redacted]

b3  
b6  
b7C  
b7E

UNITED STATES GOVERNMENT

# Memorandum

TO : SAC, WFO [redacted]

DATE: APR 10 1961

b3  
b6  
b7C  
b7E

FROM : SA [redacted]

SUBJECT: FIDEL CASTRO

[redacted]

On 3/29/61, [redacted]

[redacted] were interviewed at the above address. They furnished the names of the following individuals whom they felt were pro-CASTRO sympathizers residing in the Washington, D. C., area. Their reasons for naming these individuals were, according to them, because of statements made by these individuals in their presence or from conversations they had had with other Cubans in the Washington, D. C., area:

b6  
b7C

[Large redacted area]

b6  
b7C

⑥ - WFO

[redacted]

b3  
b6  
b7C  
b7D  
b7E

[redacted]

(6)

[redacted]

SEARCHED INDEXED  
SERIALIZED FILED  
APR 10 1961  
FBI - WASH. F. O.

b3  
b6  
b7C  
b7E

[REDACTED]

[REDACTED]

b3  
b6  
b7C  
b7E

[REDACTED] advised he would be glad to furnish any information he had which could be of interest to the FBI. He also stated that he would attempt to obtain further identifying data of the above individuals and possibly information concerning their current activities and furnish same to WFO.

It is to be noted that [REDACTED] speaks only Spanish.

b6  
b7C

F B I

Date: 12/2/63

MOB

Transmit the following in \_\_\_\_\_  
(Type in plain text or code)

Via Airtel \_\_\_\_\_  
(Priority or Method of Mailing)

To: SAC, WFO  
2 - New York

From: Director, FBI [redacted]

FIDEL CASTRO  
[redacted]

b3  
b7E

ReWFOairtel 11/23/63 captioned "Assassination of President John F. Kennedy, 11/22/63. Assaulting Federal Officer," which set forth lead to interview [redacted] concerning statement allegedly made to him by [redacted]

b6  
b7C

WFO and New York immediately advise results of interview of [redacted] and submit under this caption. If results already submitted under caption of referenced communication, furnish a copy of communication already sent to Bureau by return airtel under this caption.

[redacted]

b3  
b6  
b7C  
b7E

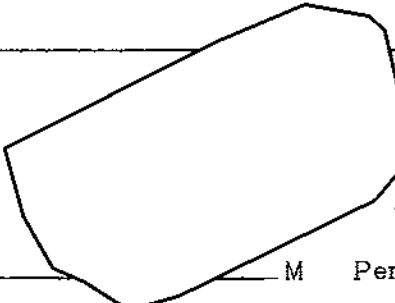

SEARCHED [redacted]  
SERIALIZED [redacted]  
DEC 3 1963  
FBI - WASH DC  
[redacted]

Sent Via \_\_\_\_\_ M Per \_\_\_\_\_

[redacted]

## Office Memorandum • UNITED STATES GOVERNMENT

TO : SAC, WFO [redacted]

FROM : [redacted]

SUBJECT: FIDEL CASTRO  
[redacted]

DATE: December 3, 1963

b3  
b6  
b7C  
b7E

Today I called Supervisor [redacted] New York Office, concerning Bureau airtel dated 12/2/63 and captioned as above, and asked him to advise me as to the status of New York's inquiry into this matter.

[redacted] called back and advised that [redacted] has not been interviewed; that he is presently out of the country in Caracas, Venezuela, and is expected back sometime this week. The New York Office has advised the Bureau that [redacted] is out of the country and the lead is still outstanding.

b6  
b7C

[redacted] called back again and advised that [redacted] had been located and interviewed on this date by the New York Office and that an appropriate communication setting forth the interview was being submitted.

1 - WFO

(1)

[redacted]  
[redacted]  
[redacted]  
[redacted]

b3  
b6  
b7C  
b7E



UNITED STATES DEPARTMENT OF JUSTICE

FEDERAL BUREAU OF INVESTIGATION

New York, New York  
December 4, 1963

In Reply, Please Refer to  
File No.

Re: Fidel Castro Ruz --

[redacted]

[redacted] Citizens Committee for a Free Cuba, 1426 G Street, Northwest, Washington, D. C., advised on November 23, 1963, that he was in contact [redacted] on November 22, 1963, with [redacted]

b3  
b6  
b7C  
b7E

[redacted] stated that [redacted] informed him that [redacted]

[redacted] knows of a plan of Fidel Castro to kill United States Ambassadors in various countries. [redacted] stated that [redacted] received this information personally from [redacted] whom he had seen [redacted] stated that this information apparently had been received by [redacted] several months ago when he was [redacted] for some time.

[redacted] on December 3, 1963, advised that he had been to Washington, D. C. on November 22-23, 1963. [redacted] stated that on November 22, 1963, he had spoken with [redacted] an associate of [redacted] of the Citizens Committee for a Free Cuba. [redacted] stated that [redacted] is the [redacted] and in all probability told [redacted] about the details of his conversation of November 22, 1963.

b6  
b7C

[redacted] advised that in June, 1962, he had made a trip to Chile in order to do a story on the Peace Corps and had then traveled to Peru on an assignment and then proceeded to Cali, Colombia, where he had an assignment to do photographic work for an international food exhibit. While in Cali, Colombia, [redacted] stated that he spoke with [redacted] in Cuba who had been very close to the government of Fidel Castro prior to his defection which took place in February, 1961. [redacted]

b6  
b7C

This document contains neither recommendations nor conclusions of the FBI. It is the property of the FBI and is loaned to your agency; it and its contents are not to be distributed outside your agency.

[redacted]	[redacted]	SEARCHED	INDEXED
[redacted]	[redacted]	SERIALIZED	FILED

b3  
b6  
b7C  
b7E



Re: Fidel Castro Ruz

advised that during one of his conversations with [redacted] [redacted] told him the following story:

b6  
b7C

[redacted] stated that one day during the latter part of 1960, he had been to the Presidential Palace in Havana where he met a friend who had just come out of a meeting with Prime Minister Fidel Castro prior to assuming his post as Cuban Ambassador to [redacted] [redacted] said that he congratulated his friend whom he stated was a former student leader during the Cuban revolution, and his friend was very discouraged and downhearted as a result of his interview with Fidel Castro. [redacted]

b6  
b7C

[redacted] stated that the new Cuban Ambassador to [redacted] left the office of Fidel Castro carrying a package and later after they had left the Presidential Palace, the new Cuban Ambassador showed [redacted] a machinegun which had been given to him by Fidel Castro, and was in the package which he carried out of the Prime Minister's office.

[redacted] stated that in conversation with the new Cuban Ambassador to [redacted] he, the new Ambassador, said that Fidel Castro told him of his plan to assassinate United States Ambassadors in 11 neutral countries in the event that the United States invaded Cuba. The new Cuban Ambassador told [redacted] that Fidel Castro was crazy, and that Castro was doing many things that he could not understand, and this was the reason why he was depressed and downhearted as a result of his interview with Castro. The new Cuban Ambassador to [redacted] told [redacted] that Castro had told him that he was selecting as Ambassadors to 11 neutral countries young revolutionaries who were dedicated to the ideals of the Cuban revolution, and that in the event the United States invaded Cuba, these 11 Cuban Ambassadors were to have a trusted staff member of the Cuban Embassy immediately seek out the United States Ambassador in that country and assassinate him.

b6  
b7C

[redacted] stated that in his conversation with [redacted] he asked [redacted] whether or not he thought this story was true, and [redacted] said that from his past knowledge of, and association with, Fidel Castro, he had implicit trust in what the new Cuban Ambassador to [redacted] had told him, and he said that Castro was crazy enough to carry out such a plan.

b6  
b7C

Re: Fidel Castro Ruz

[redacted] also advised on December 3, 1963, that at the time of his interview with [redacted] which took place in July, 1962, [redacted] had given him the name of the Cuban Ambassador to [redacted] but he did not recall his name exactly, but remembered it only as sounding like [redacted] (phonetic). [redacted] stated that this individual, [redacted] apparently had assumed his post as Ambassador to [redacted] during late 1960 or early 1961, and he was described by [redacted] as being a man in his middle thirties, who had been friendly with [redacted] [redacted] for many years in Cuba and particularly at the University of Havana.

b6  
b7c

[redacted] stated that during his conversation with [redacted] relative to this plot of Castro to assassinate United States Ambassadors in the event of a United States invasion of Cuba, [redacted] said that there were no specific individuals mentioned, but the only specific statement made by the Cuban Ambassador to [redacted] was that Castro had indicated his plan as being directed against United States Ambassadors assigned to 11 neutral countries, without naming these neutral countries.

b6  
b7c

[redacted] further stated on December 3, 1963, that while in Washington, D. C. during the period of November 22-23, 1963, he had prepared a memorandum in which he detailed his personal feelings about the possibility of the assassination of President John F. Kennedy being in some way caused by Cuban propaganda. [redacted] stated that his idea was to write a story for "Life" Magazine setting forth his thinking that the assassination of President John F. Kennedy could have been triggered by someone of the lunatic fringe who had been influenced by the constant Cuban propaganda directed against the United States and President John F. Kennedy by Prime Minister Fidel Castro. [redacted] stated that this theory was not accepted by his superiors, and in Washington, D. C. he noted that the American press was directing the opinion that the assassination of President John F. Kennedy had been brought about by someone connected with the extreme political right.

b6  
b7c

Re: Fidel Castro Ruz

[redacted] also advised on December 3, 1963, that the only national magazine which has, in any way, indicated the possibility of Cuban involvement in the assassination of President John F. Kennedy was the current issue of "US News and World Report" dated December 9, 1963. This article appears on pages 90 and 91, and it is captioned, "What Are the Odds Against Castro Now". This article sets forth the thinking that Fidel Castro is everywhere stirring up trouble and violence and, specifically, states that pro-Castro terrorists are creating problems in Venezuela and other countries of this hemisphere.

b6  
b7c



b6  
b7C

12/4/63

AIRTEL REGISTERED MAIL

TO : DIRECTOR, FBI [redacted]

b3  
b7E

FROM : SAC, NEW YORK [redacted]

SUBJECT: FIDEL CASTRO RUZ

[redacted]

ReBuairtel dated 12/2/63, entitled, "FIDEL CASTRO;  
[redacted] and WFO airtel dated 11/23/63, entitled, "ASSASSINATION  
OF PRESIDENT JOHN F. KENNEDY, 11/22/63; ASSAULTING FEDERAL  
OFFICER".

b3  
b7E

Enclosed herewith for the Bureau are 12 copies of a  
letterhead memorandum setting forth results of interview with  
[redacted] relative to information  
furnished in re WFO airtel dated 11/23/63.

b6  
b7C

There is also enclosed herewith for the information of  
the Bureau one copy of [redacted]

b6  
b7C  
b7D

[Large redacted area]

There is also enclosed for the information of the  
Bureau the article appearing in the 12/3/63 issue of "US News  
and World Report" relative to the possible indirect connection  
with the assassination of President JOHN F. KENNEDY.

4-Bureau [redacted] (Encls. 14) (RM)

(1 - [redacted])

2-WFO [redacted] (Encls. 2) (Info) (RM)

(1 - 89-75)

1-New York (89-75)

1-New York [redacted]

[redacted] (312)

(9)

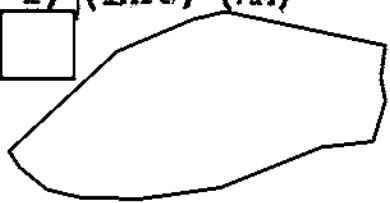

SEARCHED [redacted]	INDEXED [redacted]
SERIALIZED [redacted]	FILED [redacted]
DEC 5 1963	

b3  
b6  
b7C  
b7E

[redacted]

b3  
b6  
b7C  
b7E

During interview with [redacted] he stated that [redacted] had informed him that he had been interviewed on numerous occasions [redacted]

[redacted]

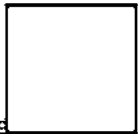

TO: SAC,

- Albany
- Albuquerque
- Anchorage
- Atlanta
- Baltimore
- Birmingham
- Boston
- Buffalo
- Butte
- Charlotte
- Chicago
- Cincinnati
- Cleveland
- Dallas
- Denver
- Detroit
- El Paso
- Honolulu

- Houston
- Indianapolis
- Jackson
- Jacksonville
- Kansas City
- Knoxville
- Las Vegas
- Little Rock
- Los Angeles
- Louisville
- Memphis
- Miami
- Milwaukee
- Minneapolis
- Mobile
- Newark
- New Haven
- New Orleans

- New York City
- Norfolk
- Oklahoma City
- Omaha
- Philadelphia
- Phoenix
- Pittsburgh
- Portland
- Richmond
- St. Louis
- Salt Lake City
- San Antonio
- San Diego
- San Francisco
- San Juan
- Savannah
- Seattle
- Springfield

- Tampa
- Washington Field
- Quantico

TO LEGAT:

- Bern
- Bonn
- London
- Manila
- Mexico, D.F.
- Ottawa
- Paris
- Rome
- Rio de Janeiro
- Tokyo

DEC 28 1964

Date \_\_\_\_\_

RE:

For information     Retention optional     For appropriate action     Surep, by \_\_\_\_\_

The enclosed is for your information. If used in a future report,  conceal all sources,  paraphrase contents.

Enclosed are corrected pages from report of SA \_\_\_\_\_ dated \_\_\_\_\_

Remarks:

b3  
b6  
b7C  
b7E

Enc.  
Bufile  
Urfile

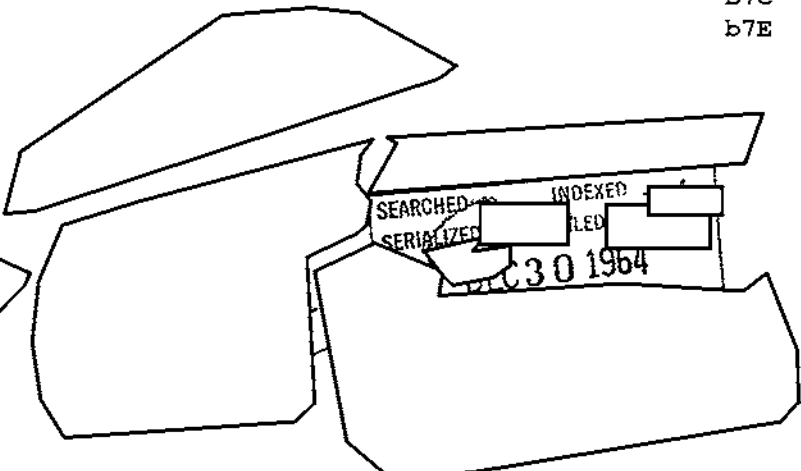

TO: SAC,

- Albany
- Albuquerque
- Anchorage
- Atlanta
- Baltimore
- Birmingham
- Boston
- Buffalo
- Butte
- Charlotte
- Chicago
- Cincinnati
- Cleveland
- Columbia
- Dallas
- Denver
- Detroit
- El Paso
- Honolulu

- Houston
- Indianapolis
- Jackson
- Jacksonville
- Kansas City
- Knoxville
- Las Vegas
- Little Rock
- Los Angeles
- Louisville
- Memphis
- Miami
- Milwaukee
- Minneapolis
- Mobile
- Newark
- New Haven
- New Orleans
- New York City

- Norfolk
- Oklahoma City
- Omaha
- Philadelphia
- Phoenix
- Pittsburgh
- Portland
- Richmond
- Sacramento
- St. Louis
- Salt Lake City
- San Antonio
- San Diego
- San Francisco
- San Juan
- Savannah
- Seattle
- Springfield

- Tampa
- Washington Field
- Quantico

TO LEGAT:

- Bern
- Bonn
- Buenos Aires
- Hong Kong
- London
- Manila
- Mexico, D.F.
- Ottawa
- Paris
- Rome
- Santo Domingo
- Tokyo

Date \_\_\_\_\_

**FEB 16 1968**

RE:

For information    
  Retention optional    
  For appropriate action    
  Surep, by \_\_\_\_\_

The enclosed is for your information. If used in a future report,  conceal all sources,  paraphrase contents.

Enclosed are corrected pages from report of SA \_\_\_\_\_ dated \_\_\_\_\_

Remarks:

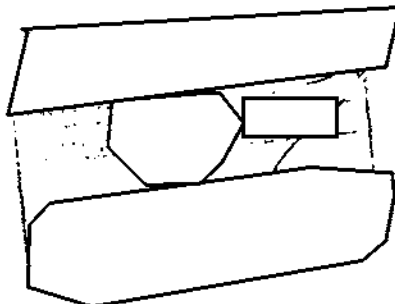

b3  
b6  
b7C  
b7E

Enc.  
Bufile  
Urfile

TO: SAC,

- Albany
- Albuquerque
- Anchorage
- Atlanta
- Baltimore
- Birmingham
- Boston
- Buffalo
- Butte
- Charlotte
- Chicago
- Cincinnati
- Cleveland
- Columbia
- Dallas
- Denver
- Detroit
- El Paso
- Honolulu

- Houston
- Indianapolis
- Jackson
- Jacksonville
- Kansas City
- Knoxville
- Las Vegas
- Little Rock
- Los Angeles
- Louisville
- Memphis
- Miami
- Milwaukee
- Minneapolis
- Mobile
- Newark
- New Haven
- New Orleans

- New York City
- Norfolk
- Oklahoma City
- Omaha
- Philadelphia
- Phoenix
- Pittsburgh
- Portland
- Richmond
- St. Louis
- Salt Lake City
- San Antonio
- San Diego
- San Francisco
- San Juan
- Savannah
- Seattle
- Springfield

- Tampa
- Washington Field
- Quantico

TO LEGAT:

- Bern
- Bonn
- Buenos Aires
- Hong Kong
- London
- Manila
- Mexico, D.F.
- Ottawa
- Paris
- Rome
- Santo Domingo
- Tokyo

Date 4/3/68

RE:

For information     Retention optional     For appropriate action     Surep, by \_\_\_\_\_

The enclosed is for your information. If used in a future report,  conceal all sources,  paraphrase contents.

Enclosed are corrected pages from report of SA \_\_\_\_\_ dated \_\_\_\_\_

Remarks:

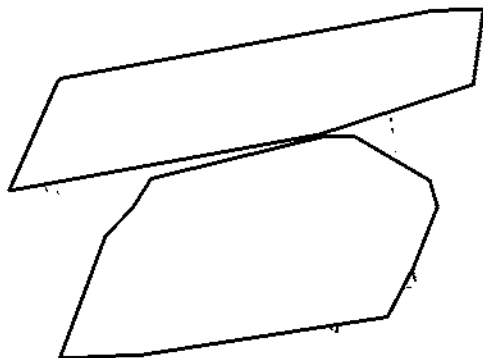

b3  
b6  
b7C  
b7E

Enc.  
Bufile  
Urfile



TO: SAC,

- Albany
- Albuquerque
- Alexandria
- Anchorage
- Atlanta
- Baltimore
- Birmingham
- Boston
- Buffalo
- Butte
- Charlotte
- Chicago
- Cincinnati
- Cleveland
- Columbia
- Dallas
- Denver
- Detroit
- El Paso
- Honolulu

- Houston
- Indianapolis
- Jackson
- Jacksonville
- Kansas City
- Knoxville
- Las Vegas
- Little Rock
- Los Angeles
- Louisville
- Memphis
- Miami
- Milwaukee
- Minneapolis
- Mobile
- Newark
- New Haven
- New Orleans
- New York City

- Norfolk
- Oklahoma City
- Omaha
- Philadelphia
- Phoenix
- Pittsburgh
- Portland
- Richmond
- Sacramento
- St. Louis
- Salt Lake City
- San Antonio
- San Diego
- San Francisco
- San Juan
- Savannah
- Seattle
- Springfield

- Tampa
- ~~Washington Field~~
- Quantico

TO LEGAT:

- Bern
- Bonn
- Buenos Aires
- Hong Kong
- London
- Madrid
- Mexico, D.F.
- Ottawa
- Paris
- Rome
- Tokyo

Date DEC 2 1970

RE:

For information     Retention optional     For appropriate action     Surep, by \_\_\_\_\_

The enclosed is for your information. If used in a future report,  
 conceal all sources,  paraphrase contents.

Enclosed are corrected pages from report of SA \_\_\_\_\_  
dated \_\_\_\_\_.

Remarks:

b3  
b6  
b7C  
b7E

Enc.  
Bufile  
Urfile

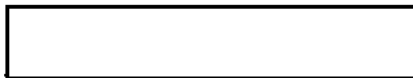

SEARCHED \_\_\_\_\_ INDEXED \_\_\_\_\_  
SERIALIZED \_\_\_\_\_ FILED \_\_\_\_\_

DEC 3 1970



TO: SAC:

- Albany
- Albuquerque
- Alexandria
- Anchorage
- Atlanta
- Baltimore
- Birmingham
- Boston
- Buffalo
- Butte
- Charlotte
- Chicago
- Cincinnati
- Cleveland
- Columbia
- Dallas
- Denver
- Detroit
- El Paso
- Honolulu
- Houston
- Indianapolis
- Jackson
- Jacksonville
- Kansas City
- Knoxville
- Las Vegas
- Little Rock
- Los Angeles
- Louisville
- Memphis
- Miami
- Milwaukee
- Minneapolis
- Mobile
- Newark
- New Haven
- New Orleans
- New York City
- Norfolk

- Oklahoma City
- Omaha
- Philadelphia
- Phoenix
- Pittsburgh
- Portland
- Richmond
- Sacramento
- St. Louis
- Salt Lake City
- San Antonio
- San Diego
- San Francisco
- San Juan
- Savannah
- Seattle
- Springfield
- Tampa
- Washington Field
- Quantico

TO LEGAT:

- Beirut
- Bern
- Bonn
- Brasilia
- Buenos Aires
- Caracas
- Copenhagen
- Hong Kong
- La Paz
- London
- Madrid
- Managua
- Manila
- Mexico City
- Ottawa
- Paris
- Rome
- Singapore
- Tel Aviv
- Tokyo

RE:

Date OCT 30 1973



b3  
b7E

- For information  Retention optional  For appropriate action  Surep. by \_\_\_\_\_
- The enclosed is for your information. If used in a future report,  conceal all sources,  paraphrase contents.
- Enclosed are corrected pages from report of SA \_\_\_\_\_ dated \_\_\_\_\_

Remarks:

b3  
b6  
b7C  
b7E

Enc.

Bufile  
Urfile

SEARCHED  INDEXED

SERIALIZED  FILED

OCT 31 1973

FBI-WASHINGTON FIELD OFFICE

~~SECRET MATERIAL ATTACHED~~

(Copies to O... Checked)

Routing Slip  
0-7 (Rev. 12-17-73)

TO: SAC:

- Albany
- Albuquerque
- Alexandria
- Anchorage
- Atlanta
- Baltimore
- Birmingham
- Boston
- Buffalo
- Butte
- Charlotte
- Chicago
- Cincinnati
- Cleveland
- Columbia
- Dallas
- Denver
- Detroit
- El Paso
- Honolulu
- Houston
- Indianapolis
- Jackson
- Jacksonville
- Kansas City
- Knoxville
- Las Vegas
- Little Rock
- Los Angeles
- Louisville
- Memphis
- Miami
- Milwaukee
- Minneapolis
- Mobile
- Newark
- New Haven
- New Orleans
- New York City
- Norfolk

- Oklahoma City
- Omaha
- Philadelphia
- Phoenix
- Pittsburgh
- Portland
- Richmond
- Sacramento
- St. Louis
- Salt Lake City
- San Antonio
- San Diego
- San Francisco
- San Juan
- Savannah
- Seattle
- Springfield
- Tampa
- Washington Field
- Quantico

- C-1  
5-5
- TO LEGAT:
- Beirut
  - Bern
  - Bonn
  - Brasilia
  - Buenos Aires
  - Caracas
  - Hong Kong
  - London
  - Madrid
  - Manila
  - Mexico City
  - Ottawa
  - Paris
  - Rome
  - Singapore
  - Tel Aviv
  - Tokyo

b3  
b7E

RE:

Date **February 24, 1975**

Retention For appropriate

- For information  optional  action  Surep, by \_\_\_\_\_
- The enclosed is for your information. If used in a future report,  conceal all sources,  paraphrase contents.
- Enclosed are corrected pages from report of SA \_\_\_\_\_ dated \_\_\_\_\_

Remarks:

b3  
b6  
b7C  
b7E

DECLASSIFICATION AUTHORITY DERIVED FROM:  
FBI AUTOMATIC DECLASSIFICATION GUIDE  
DATE 03-29-2023 BY: [redacted]

Enc.  
Bufile  
Urfile

SEARCHED  
SERIALIZED

INDEXED  
FILED

FEB 25 1975

FBI-WASH. FIELD

~~SECRET MATERIAL ATTACHED~~

~~SECRET MATERIAL ATTACHED~~

(Copies to  Checked)

Routing Slip  
0-7 (Rev. 12-17-73)

NO FOREIGN DISSEMINATION

TO: SAC:

- Albany
- Albuquerque
- Alexandria
- Anchorage
- Atlanta
- Baltimore
- Birmingham
- Boston
- Buffalo
- Butte
- Charlotte
- Chicago
- Cincinnati
- Cleveland
- Columbia
- Dallas
- Denver
- Detroit
- El Paso
- Honolulu

- Houston
- Indianapolis
- Jackson
- Jacksonville
- Kansas City
- Knoxville
- Las Vegas
- Little Rock
- Los Angeles
- Louisville
- Memphis
- Miami
- Milwaukee
- Minneapolis
- Mobile
- Newark
- New Haven
- New Orleans
- New York City
- Norfolk

- Oklahoma City
- Omaha
- Philadelphia
- Phoenix
- Pittsburgh
- Portland
- Richmond
- Sacramento
- St. Louis
- Salt Lake City
- San Antonio
- San Diego
- San Francisco
- San Juan
- Savannah
- Seattle
- Springfield
- Tampa
- Washington Field
- Quantico

TO LEGAT:

- Beirut
- Bern
- Bonn
- Brasilia
- Buenos Aires
- Caracas
- Hong Kong
- London
- Madrid
- Manila
- Mexico City
- Ottawa
- Paris
- Rome
- Singapore
- Tel Aviv
- Tokyo

RE: \_\_\_\_\_ Date April 18, 1975

[Redacted]

- For information  Retention optional  For appropriate action  Surep, by \_\_\_\_\_
- The enclosed is for your information. If used in a future report, sources,  paraphrase contents. \_\_\_\_\_
- Enclosed are corrected pages from report of SA \_\_\_\_\_ dated \_\_\_\_\_

Remarks:

*Self* [Redacted]

DECLASSIFICATION AUTHORITY DERIVED FROM:  
FBI AUTOMATIC DECLASSIFICATION GUIDE  
DATE 03-06-2023 BY: \_\_\_\_\_

b3  
b6  
b7C  
b7E

SEARCHED \_\_\_\_\_ INDEXED \_\_\_\_\_  
SERIALIZED \_\_\_\_\_ FILED \_\_\_\_\_  
APR 21 1975  
FBI - WASH. FIELD OF

[Redacted]

Enc.  
Bufile  
Urfile

~~SECRET MATERIAL ATTACHED~~

To : Washington

Date 9/5/02

From : Newark

Subject:

[Redacted]

(Title)

RUC  
 File Destruction Program

b3  
b7E

Enclosed are 3 items.

These items are forwarded to your office since file meets criteria for destruction.

Enclosures are described as follows:

- Original Notes.
- Original FD-302's.
- Laboratory and/or Technical Reports.
- Miscellaneous Documents.

Enc.

NOTE: DO NOT BLOCK STAMP ORIGINAL ENCLOSURES.

[Redacted]

b3  
b7E

FEDERAL BUREAU OF INVESTIGATION  
FOI/PA  
DELETED PAGE INFORMATION SHEET  
FOI/PA# 1362425-000

Total Deleted Page(s) = 3  
Page 5 ~ Duplicate;  
Page 6 ~ Duplicate;  
Page 8 ~ Duplicate;

XXXXXXXXXXXXXXXXXXXXXXXXXXXX  
X Deleted Page(s) X  
X No Duplication Fee X  
X For this Page X  
XXXXXXXXXXXXXXXXXXXXXXXXXXXX

VZCZCHQ0126

PP AFO

DE HQ 0126 2392305

ZNY CCCCC

P 272126Z AUG 81

FM DIRECTOR FBI

TO ALL FBI FIELD OFFICES PRIORITY

BT

~~CONFIDENTIAL~~

POSSIBLE VISIT OF CUBAN PRESIDENT FIDEL CASTRO TO NEW YORK CITY,  
SEPTEMBER 4 THROUGH 6, 1981; PFO; OO: NEW YORK

ON AUGUST 20, 1981, [REDACTED]

[REDACTED] ADVISED FBIHQ THAT THEY HAD RECEIVED

INFORMATION [REDACTED] THAT

PRESIDENT FIDEL CASTRO OF CUBA TENTATIVELY PLANS TO VISIT  
NEW YORK CITY, SEPTEMBER 4 THROUGH 6, 1981, FOR THE TWENTIETH  
ANNIVERSARY OF THE NON-ALIGNED MOVEMENT. THIS COINCIDES WITH  
THE OPENING OF THE UNITED NATIONS GENERAL ASSEMBLY. DETAILS  
OF HIS ITINERARY HAVE NOT YET BEEN RECEIVED. (X) (U)

IT IS REQUESTED THAT RECIPIENTS WITH APPROPRIATE SOURCES  
CONTACT THEM TO DETERMINE IF PRESIDENT CASTRO'S POSSIBLE  
VISIT TO THE UNITED STATES IS KNOWN BY ANTI-CASTRO OR OTHER

b7E

*9/2/81*  
*DAA*  
*8/28/81*

185-195-1

SEARCHED	INDEXED
SERIALIZED	FILED

[REDACTED]

b6  
b7c

ELEMENTS WHO MIGHT PRESENT A THREAT TO HIS SECURITY. IF SO, DETERMINE THROUGH THESE SOURCES WHETHER OR NOT ANY INDIVIDUALS OR GROUPS HAVE TARGETED HIM FOR VIOLENCE DURING HIS VISIT. EXTREME CAUTION IS TO BE USED WHEN CONTACTING SOURCES TO INSURE THAT IF CASTRO'S POSSIBLE VISIT IS NOT YET KNOWN, THE ANTI-CASTRO COMMUNITY IS NOT MADE AWARE OF IT. OTHER OFFICES ARE REQUESTED TO IMMEDIATELY NOTIFY FBIHQ OF ANY INFORMATION RECEIVED PERTINENT TO THE POSSIBLE VISIT OF CASTRO TO THE UNITED STATES. ~~(S)~~ (U)

[REDACTED]

[REDACTED]

b7E

ALL INTERVIEWS, WHERE APPROPRIATE, WILL BE CONDUCTED JOINTLY BY FBI [REDACTED] POSITIVE INFORMATION ONLY IS TO BE FURNISHED. ~~(S)~~ (U)

~~C & E 8024, REASONS 2 & 3, DRD AUGUST 27, 2001.~~

BT

0126

NNNN



FBI

TRANSMIT VIA:

- Teletype
- Facsimile
- \_\_\_\_\_

PRECEDENCE:

- Immediate
- Priority
- Routine

CLASSIFICATION:

- TOP SECRET
- SECRET
- ~~CONFIDENTIAL~~
- UNCLAS E F T O
- UNCLAS

Date 9/4/81

012

FM BALTIMORE (185-195) (SQ. 3) -P-

TO DIRECTOR ROUTINE

356 [redacted]

NEW YORK ROUTINE

416 [redacted]

BT

~~CONFIDENTIAL~~

POSSIBLE VISIT OF CUBAN PRESIDENT FIDEL CASTRO TO NEW YORK CITY,  
SEPTEMBER 4 THROUGH 6, 1981; PFO; OO: NEW YORK

RE BUREAU TELETYPE TO ALL OFFICES, AUGUST 27, 1981. (U)

APPROPRIATE SOURCES BALTIMORE CONTACTED AND COULD PROVIDE  
NO INFORMATION RELEVANT TO CAPTIONED VISIT. BALTIMORE WILL REMAIN  
ALERT FOR SOURCE INFORMATION OF VALUE AND IMMEDIATELY FURNISH SAME  
TO APPROPRIATE OFFICES. ~~(S)~~ (U)

C AND E 3902, REASON (2&3), DRD SEPTEMBER 4, 2001.

BT

#

1 - [redacted]

[redacted]

[redacted]

SEARCHED.....  
INDEXED.....  
SERIALIZED.....  
FILED.....

4 SEP 01 10 20 AM '81

185-195-2

b6  
b7C

b6  
b7C  
b7D

Approved: EDH

[redacted]

Transmitted

(Number)

012

(Time)

Per

[redacted]

b6  
b7C

~~CONFIDENTIAL~~

b6  
b7c

X AIRTEL

9/16/81

TO: DIRECTOR

FROM: SAC, BALTIMORE (185-195)(SQ/3)(RUC)

POSSIBLE VISIT OF CUBAN PRESIDENT  
FIDEL CASTRO TO NEW YORK CITY,  
SEPTEMBER 4, - 6, 1981  
PFO  
OO: NY

*Handwritten:* #6-6-81  
10-6-81

b6  
b7c

Re Baltimore teletype to Bureau, 9/4/81.

(U)

Canvas of appropriate sources in Baltimore,  
failed to reveal any information regarding captioned  
matter, and no further investigation being conducted  
this office.

~~(S)~~

(U)

~~Classified and Extended by 3902  
Reason for Extension FCIM, II, 1-2.4.2 (2 and 3)  
Date of Review for Declassification September 16, 2001~~

- 2 - Bureau
- 2 - New York
- 2 - Baltimore (1 - [redacted])

[redacted] (6)  
7/7/81

[redacted]

b6  
b7c  
b7d

Searched [redacted]  
Serialized [redacted]  
Indexed [redacted]  
Filed [redacted]

b6  
b7c

~~CONFIDENTIAL~~

185-195-3

VZCZGH00193  
RP MM  
DE HQ 0193 1550900  
ZNY CCCCC  
R 032110Z JUN 83  
FM DIRECTOR FBI  
TO FBI MIAMI ROUTINE  
BT

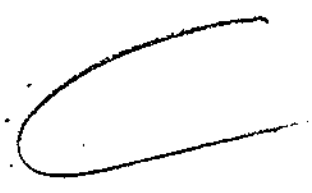

Unsub;

~~CONFIDENTIAL~~  
Plot to

UNSUBSINGPLOD:MIAMIASSASSINATE FIDEL CASTRO; PFO - INFORMATION

ON JUNE 3, 1983, [redacted]

[redacted]

TELEPHONE NUMBER [redacted] TELEPHONICALLY ADVISED THAT ON  
JUNE 2, 1983, [redacted] HAD RECEIVED

A TELEPHONE CALL FROM [redacted] A REPORTER FOR THE "MIAMI  
HERALD" NEWSPAPER. [redacted] ALLEGEDLY WRITES NEWSPAPER ARTICLES  
ON CUBAN EXILES IN THE MIAMI AREA AND ON THE CUBAN GROUPS  
OMEGA 7 AND ALPHA 66. [redacted] ADVISED [redacted]

b6  
b7C  
b7E

[redacted] THAT HE HAS KNOWLEDGE OF A CURRENT PLOT WITHIN THE  
CUBAN EXILE COMMUNITY IN MIAMI TO ASSASSINATE FIDEL CASTRO.

[redacted] WANTED CORROBORATION OF HIS STORY AND ASKED QUESTIONS

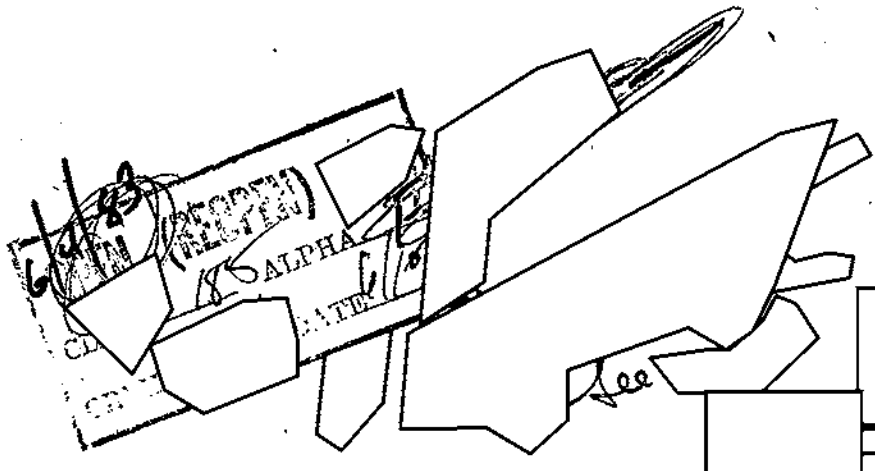

185A-169-1

[redacted]  
[redacted]  
[redacted]  
[redacted]  
[redacted]

b6  
b7C

ABOUT A PREVIOUS PLOT TO ASSASSINATE CASTRO IN 1979. [REDACTED]  
WAS NOT GIVEN ANY INFORMATION [REDACTED] BUT [REDACTED] DID  
VERIFY THAT [REDACTED] WAS IN FACT A REPORTER FOR THE "MIAMI HERALD."

b6  
b7C  
b7E

[REDACTED]  
[REDACTED] TO CONTACT [REDACTED] FOR FURTHER INFORMATION, AND WISHES  
THE FBI TO ACCOMPANY THEM DURING THE INTERVIEW. THEY ANTICIPATE  
CONTACTING THE FBI, MIAMI OFFICE ON MONDAY, JUNE 6, 1983.

MIAMI, [REDACTED] WILL ACCOMPANY THEM  
DURING INTERVIEW OF REPORTER [REDACTED] AND ADVISE FBIHQ  
OF RESULTS.

b6  
b7C  
b7E

~~C BY 8411, DECL: OADR~~

BT

0193

NNNN

MM 0925 1602245Z

DF MM

R 0102245S JUN 83

FM MIAMI (185A-MFW) (C)

TO DIRECTOR ROUTINE

BT

~~CONFIDENTIAL~~

UNSUB; PLOT TO ASSASSINATE FIDEL CASTRO; PFO - INFORMATION.

RE BUREAU TELETYPE TO MIAMI DATED JUNE 3, 1983.

[redacted]

b6  
b7C  
b7E

CONTACTED THIS DATE AND HE PROVIDED THE FOLLOWING INFORMATION:

HE TELEPHONED [redacted] ON JUNE 9, 1983, IN AN ATTEMPT TO  
ARRANGE INTERVIEW WITH HIM IN CONNECTION WITH CAPTIONED MATTER.

[redacted] ACKNOWLEDGED DISCUSSING PLOT ON LIFE OF FIDEL CASTRO [redacted]

[redacted]

b6  
b7C  
b7E

[redacted]

BUT DENIED THAT

CONVERSATION RELATED TO ANY CURRENT ASSASSINATION PLAN. HE TOLD

[redacted] THAT HE WAS MERELY TRYING TO CONFIRM AND EXPAND UPON INFOR-

MATION REGARDING AN ALLEGED ASSASSINATION PLOT ON PART OF CUBAN

EXILES DURING VISIT BY CASTRO TO UNITED STATES IN 1979. ALL INFOR-

Searched \_\_\_\_\_  
Indexed \_\_\_\_\_  
Serialized \_\_\_\_\_  
Filed \_\_\_\_\_

[redacted]

b6  
b7C

DATE 11/20/90 [redacted] /S/TTC  
Extra copies purged and  
destroyed pursuant to  
instructions in BuA/T  
11/3/86

185A-169-2

PAGE TWO MM (185-NEW) ~~C O N F I D E N T I A L~~

MATION THAT HE IS IN POSSESSION OF EMANATED FROM CUBAN EXILE SOURCES  
IN MIAMI AND HE DEFINITELY HAS NO DATA CONCERNING A CURRENT PLAN TO  
KILL CASTRO. [ ] DECLINED INTERVIEW [ ]

b6  
b7C  
b7E

[ ] AND STATED THAT HE AND HIS NEWSPAPER, THE MIAMI HERALD, WERE  
NOT IN THE BUSINESS OF GETTING INFORMATION ON ANY INTERNATIONAL  
PLOTS.

MIAMI, ACCORDINGLY, CONDUCTING NO FURTHER INVESTIGATION.

~~C BY G-3; DECL: OADP.~~

BT

FEDERAL BUREAU OF INVESTIGATION  
FOI/PA  
DELETED PAGE INFORMATION SHEET  
FOI/PA# 1362425-000

Total Deleted Page(s) = 9

- Page 6 ~ Duplicate;
- Page 7 ~ Duplicate;
- Page 13 ~ Duplicate;
- Page 14 ~ Duplicate;
- Page 15 ~ Duplicate;
- Page 16 ~ Duplicate;
- Page 20 ~ Duplicate;
- Page 21 ~ Duplicate;
- Page 22 ~ Duplicate;

```
XXXXXXXXXXXXXXXXXXXXXXXXXXXXX  
X Deleted Page(s) X  
X No Duplication Fee X  
X For this Page X  
XXXXXXXXXXXXXXXXXXXXXXXXXXXXX
```

BU0017 2402104Z

RR HQ NY

DE BU

R 282104Z AUG 81

FX BUFFALO (185-30) (RUC)

TO DIRECTOR ROUTINE

NEW YORK ROUTINE

BT

~~CONFIDENTIAL~~

POSSIBLE VISIT OF CUBAN PRESIDENT FIDEL CASTRO TO NEW YORK

CITY, SEPT. 4 - 6, 1981; PFO; OO: NEW YORK.

RE BUREAU TELETYPE, AUG. 27, 1981.

THIS ENTIRE COMMUNICATION IS CLASSIFIED ~~CONFIDENTIAL~~.

ON AUGUST 14, 1981, LIMITED CIVIL RIGHTS INVESTIGATION INITIATED BASED ON A CIVIL RIGHTS COMPLAINT FROM VICTIM, [redacted]

[redacted] TELEPHONE [redacted] VICTIM INTERVIEWED ON AUGUST 20, 1981 AND ADVISED ON AUGUST 13,

1981 [redacted] HAD AN ARGUMENT IN WHICH [redacted] STATED HE DID NOT LIKE PRESIDENT REAGAN. [redacted]

[redacted] THEN CALLED U.S. SECRET SERVICE, IN ANGER, REGARDING THEIR

185-1563-X

10 SEP 2 1981

[redacted]

073106  
9/31/81

[redacted]

RECEIVED  
TELETYPE UNIT

RECEIVED  
FEDERAL BUREAU  
OF INVESTIGATION  
COMMUNICATIONS SECTION

Exec AD-Adm	
Exec AD-Inv	
Exec AD-LES	
Asst Dir:	
Adm. Serv.	
Crim. Inv.	
Ident.	
Insp.	
Intell.	
Laboratory	
Legal Coun.	
Rec. Mgmt.	
Tech. Serv.	
Training	
Off. of Cong. & Public Affs.	b6 b7c
Telephone Rm.	
Director's Sec'y	



ARGUMENT. VICTIM WAS INTERVIEWED THAT DAY BY TWO UNITED STATES  
SECRET SERVICE AGENTS. ON AUGUST 20, 1981, VICTIM WAS INTER-  
VIEWED BY FBI AND HE ADVISED THAT DURING THE INTERVIEW WITH  
THE SECRET SERVICE MEN, HE WAS SLAPPED AND PUSHED AROUND.  
VICTIM, WHO WAS INTERVIEWED IN FRONT OF HIS ATTORNEY, ADMITTED  
TO FBI AGENTS HE WAS NOT PHYSICALLY ABUSED, BUT CLAIMED HE WAS  
MENTALLY ABUSED. VICTIM ALSO ADMITTED DISLIKE FOR PRESIDENT  
REAGAN. DURING INTERVIEW, [REDACTED] STATED TO FBI THAT IF  
FIDEL CASTRO EVER CAME TO ROCHESTER, NEW YORK, HE WOULD "BLOW  
HIS HEAD OFF". VICTIM ALSO ADMITTED TO BEING MENTALLY DISABLED.

b6  
b7c

[REDACTED] WAS DESCRIBED AS WHITE MALE, BORN [REDACTED]

[REDACTED] HE SAID [REDACTED] AND LIVED AT

[REDACTED] BEFORE COMING TO

[REDACTED], BORN [REDACTED] ALSO WAS

INTERVIEWED. HE STATED [REDACTED] IS A VERY NERVOUS PERSON  
WHO SPEAKS VERY VIOLENTLY BUT HE IS NOT A VIOLENT ACTING PER-  
SON. CIVIL RIGHTS CASE CAPTIONED [REDACTED]

b6  
b7c

[REDACTED] - VICTIM", CLOSED BY REPORT AT BUFFALO DATED AUGUST 14, 1981.

PAGE THREE BU 185-30 ROUTINE

ON AUGUST 28, 1981, INFORMATION CONCERNING STATEMENT MADE  
BY [ ] ON AUGUST 20, 1981 TO BUAGENT RE CASTRO FURNISHED [ ]  
[ ] BUFFALO, NEW YORK.

NO FURTHER ACTION BEING ATAKEN AT THIS TIME BY BUFFALO.

~~C & E 6166. REASONS 2 & 3 DRD AUGUST 28, 2001.~~

BT

b6  
b7C  
b7E

~~CONFIDENTIAL~~

NOTE: ATTACHED ADVISES OF POSSIBLE VISIT OF THE UNITED STATES  
BY CUBAN PRESIDENT FIDEL CASTRO AND INSTRUCTS ALL FBI  
FIELD OFFICES TO CONTACT LOGICAL SOURCES TO DETERMINE THE POTENTIAL  
FOR VIOLENCE WHICH COULD BE DIRECTED AGAINST PRESIDENT CASTRO DURING  
HIS VISIT. ~~(S)~~ (U)



b7E



~~(S)~~ (U)

SEARCHED \_\_\_\_\_  
SERIALIZED \_\_\_\_\_  
INDEXED \_\_\_\_\_  
FILED \_\_\_\_\_  
MAR 24 1964  
FBI - [redacted]

b6  
b7C



~~CONFIDENTIAL~~

b6  
b7C

CG0010 2382208

[redacted] RECEIVED  
ELETYPE UNIT

RR HQ  
DE CG

26 AUG 81 22 30

R 262208Z AUG 81  
FM CHICAGO (185-NEW) (SQUAD 13)

RECEIVED  
FEDERAL BUREAU  
OF INVESTIGATION  
COMMUNICATIONS SECTION

TO DIRECTOR ROUTINE  
MIAMI ROUTINE  
NEWARK ROUTINE  
NEW YORK ROUTINE

Exec AD-Adm.	
Exec AD-Inv.	
Exec AD-LEG	
Asst. Dir.:	
Adm. Serv.	
Crim. Inv.	
Ident.	
Inspection	
Intell.	
Laboratory	
Legal Coun.	
Rec. Mgmt.	
Tech. Serv.	
Training	
Off. of Cong. & Public Affs.	
Telephone Rm.	
Director's Sec'y	

BT

~~CONFIDENTIAL~~

VISIT OF FIDEL CASTRO TO U.S.: PROTECTION OF FOREIGN OFFICIALS.

THIS COMMUNICATION IS CLASSIFIED ~~CONFIDENTIAL~~ IN ITS ENTIRETY.

ON INSTANT DATE, [redacted]

[redacted] ADVISED OF UPCOMING VISIT OF FIDEL

CASTRO TO THE U.S. ON SEPTEMBER 4, 1981.

REQUEST CONSISTED OF IDENTIFICATION OF GROUPS OR INDIVIDUALS THAT MIGHT POSE A THREAT TO CASTRO.

NO INDIVIDUALS WERE IDENTIFIED IN THE CHICAGO AREA,

185-1563-2

[redacted]

[redacted]

23 AUG 28 1981

b6  
b7C

b6  
b7C  
b7E

b6  
b7C

PAGE TWO CG 185-NEW ~~C O N F I D E N T I A L~~

BUT NAMES OF ANTI-CASTRO GROUPS THAT HAVE COME TO THE ATTENTION OF CHICAGO WERE PROVIDED. THESE GROUPS INCLUDE: ALPHA 66, OMEGA 7, JUNTA PATRIOTICA CUBANA (JPC), CUBAN NATIONALIST MOVEMENT (CNM), AND CUBA INDEPENDENTE Y DEMOCRATICA (CID).

THE BUREAU IS REQUESTED TO ADVISE IF CASTRO VISITING CHICAGO OR IF ANY INFORMATION IS AVAILABLE REGARDING PLANNED ANTI-CASTRO ACTIVITIES. CHICAGO WILL CONTACT  IN EFFORT TO DEVELOP ADDITIONAL INFORMATION.

~~C AND E 7496, REASON 2 AND 3, DRD AUGUST 26, 2001.~~

BT

b7E



MESSAGE RELAY VIA TELETYPE

019

DATE 8/31	CLASSIFICATION <del>CONF.</del>	PRECEDENCE Routine
--------------	------------------------------------	-----------------------

FM DIRECTOR FBI

TO [redacted]  
[redacted]

FEDERAL GOVERNMENT 22

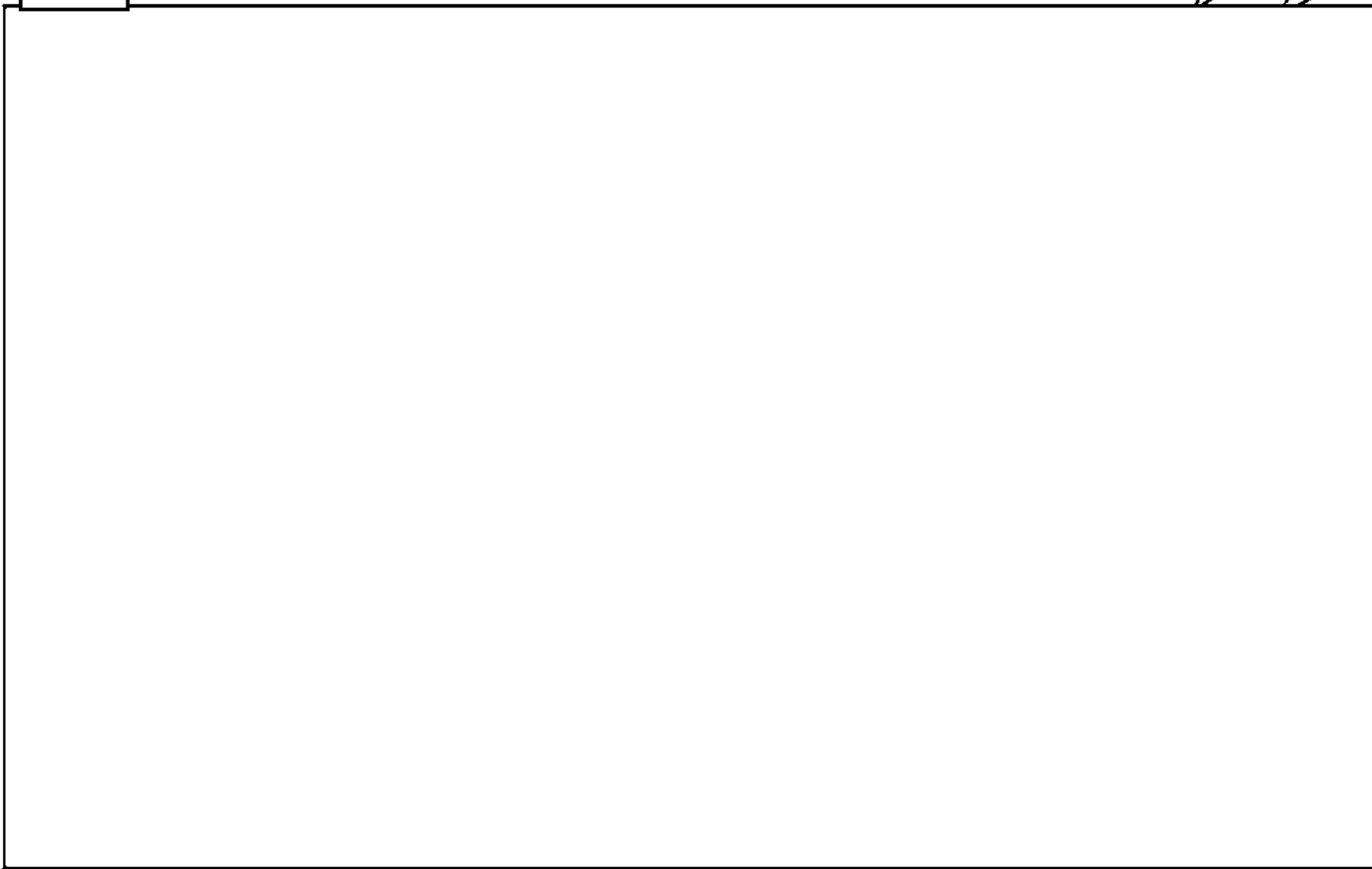

b3  
b6  
b7C  
b7E

SUBJECT:

*see attached*

APPROVE <i>CM</i>	[redacted]	ROOM 4084	TELE EXT. 4650
----------------------	------------	--------------	-------------------

185-15633

FEDERAL BUREAU OF INVESTIGATION  
COMMUNICATIONS CENTER  
181501  
AUG 31 1981

SEP 1 1981

b6  
b7C

39 SEP 24 1981 DO NOT FILE WITHOUT COMMUNICATIONS STAMP

059.148



b6  
b7c

### USE OF FORM 0-73

1. Only incoming teletype messages which require transmission relay may be prepared for transmission using form 0-73. Use of form 0-73 is restricted to incoming teletype messages received within the last 3 days which require transmission relay; all other teletype messages must be prepared using form 0-93.
2. Additions such as notes and administrative data for a specific addressee are not allowed. If a note or administrative data is required for a particular addressee a separate 0-73 form must be prepared.
3. The message will be transmitted just as it appears. The person approving the message is solely responsible for assuring all necessary editing changes have been made.

### PREPARATION OF FORM WHICH CONSISTS OF A PREPRINTED YELLOW.

1. Complete appropriate boxes: date, classification & precedence.
2. List addresses immediately following the "TO" or place a check mark in the appropriate boxes.
3. Type or PRINT the subject in the space provided.
4. Print or type originator's name, room number and telephone extension.
5. Indicate approval for transmission by initialing the "Approved By" box.

FEDERAL BUREAU OF INVESTIGATION  
 COMMUNICATIONS SECTION  
 31 AUG 81 15 09 Z  
 RE  
 TEL

### PREPARATION OF MESSAGE TO BE TRANSMITTED

1. Xerox 1 copy of incoming teletype message. A notation shall be made on the original incoming teletype "1 copy made for relay to SACS \_\_\_\_\_, (OR LEGATS) \_\_\_\_\_, (OR GOVERNMENT AGENCIES) \_\_\_\_\_."
2. Minor editing changes shall be made on the xerox as follows: using a lead pencil ONLY draw single line through the first and last lines of the heading and connect these lines from top right to bottom left forming a "Z," figure. (DO NOT OBLITERATE THE HEADING.) Use horizontal lines to delete sentences or words. Printed changes of a word or two to the text of the message may be made; however, changes to the existing text involving more than a word or two necessitate the originator to initiate a new message using form 0-93.
3. Administrative data or notes may be typed immediately following the text and will be transmitted to all addressees.
4. When using the 0-73 form to disseminate information to field offices, Legal Attaches and other Government agencies simultaneously, the text, notes and administrative data must be identical for all addressees.

NK0008 2522051

RR HI NY

DE NK

R 092051Z SEP 81

FM NEWARK (185-147) (RUC) (FCI-1)

TO DIRECTOR (ROUTINE)

NEW YORK (ROUTINE)

BT

UNCLAS E F T O

POSSIBLE VISIT OF CUBAN PRESIDENT FIDEL CASTRO TO NEW YORK CITY

SEPTEMBER 4-6, 1981; PFO; OO: NEW YORK

*Cuba*

RE BUTEL AUGUST 27, 1981, AND SAN JUAN TEL SEPTEMBER 2, 1981.

THIS MATTER IS BEING RUC'D IN THAT CAPTIONED VISIT DID NOT OCCUR.

BT

RECEIVED  
TELETYPE UNIT

9 00 01 20 37 Z

RECEIVED  
FEDERAL BUREAU  
OF INVESTIGATION  
COMMUNICATIONS SECTION

Exec. AD	
Exec. AD	
Exec. AD	
Asst. Dir.:	
Adm. Serv.	
Crim. Inv.	
Ident.	
Inspect.	
Intell.	
Laboratory	
Legal Coun.	
Rec. Mgmt.	
Tech. Serv.	
Training	
Off. of Cong. & Public Affs.	
Telephone Rm.	
Director's Sec'y	

b6  
b7C

[Redacted]

[Redacted]

[Redacted]

[Redacted]

185-1563-5

15 SEP 13 1981

b6  
b7C

b6  
b7C

66 SEP 13 1981

[Redacted]

[Redacted]

25 2522055Z HQ 1

[Redacted]



FBI

TRANSMIT VIA:

- Teletype
- Facsimile
- AIRTEL

PRECEDENCE:

- Immediate
- Priority
- Routine

CLASSIFICATION:

- TOP SECRET
- SECRET
- CONFIDENTIAL
- UNCLAS E F T O
- UNCLAS

Date 9/8/81

~~CONFIDENTIAL~~

TO: DIRECTOR, FBI

FROM: SAC, CLEVELAND (195-111) (RUC)

RE: POSSIBLE VISIT OF CUBAN PRESIDENT  
FIDEL CASTRO TO NEW YORK CITY,  
9/4-6/81;  
PFO

b6  
b7C

OO: NEW YORK

Re Bureau teletype dated 8/27/81. (U)

Contact with appropriate sources regarding captioned matter was negative. (U)

Sources advised they were not aware of any contemplated visits now or in the future of captioned individual. (U)

b6  
b7C

~~CONFIDENTIAL~~

CLASSIFIED AND EXTENDED BY 8618  
REASON FOR EXTENSION FCIM, II, 1-2, 4, 2, (2) (3)  
DATE OF REVIEW FOR DECLASSIFICATION 9/8/2001

185-1563-6

9 SEP 15 1981

b6  
b7C

- ② - Bureau (RM)
- 1 - New York (RM)
- 1 - Cleveland

[redacted]  
(4)

[redacted]

b6  
b7C

59 SEP 1981

[redacted]

Transmitted \_\_\_\_\_ (Number) \_\_\_\_\_ (Time)

Per \_\_\_\_\_

RECEIVED  
TELETYPE UNIT

b6  
b7c

H00011 2550125Z

RR HQ

DE HQ

R 11 2200Z SEP 81

FM HOUSTON (185-83) (RUC)

TO DIRECTOR ROUTINE

BT [redacted]

[redacted]

SEP 81 01 34z  
RECEIVED  
FEDERAL BUREAU  
OF INVESTIGATION  
COMMUNICATIONS SECTION

Exec. AD-Adm.	_____
Exec. AD-Inv.	_____
Exec. AD-LES	_____
Asst. Dir.:	
Adm. Serv.	_____
Crim. Inv.	_____
Ident.	_____
Inspection	_____
Intell.	_____
Laboratory	_____
Legal Coun.	_____
Plan. & Insp.	_____
Rec. Mgmt.	_____
Tech. Serv.	_____
Training	_____
Off. Cong. & Public Affs.	_____
Telephone Rm.	_____
Director's Sec'y	_____

b6  
b7c

~~CONFIDENTIAL~~

POSSIBLE VISIT OF CUBAN PRESIDENT FIDEL CASTRO TO NEW YORK CITY,  
SEPTEMBER 4 THROUGH 6, 1981; PFO. OO: NEW YORK.

HOUSTON DIVISION IN POSSESSION OF NO POSITIVE INFORMATION  
PERTAINING TO CAPTIONED ACTIVITY.

C & E 220, REASONS 2 & 3, DRD SEPTEMBER 11, 2001.

b6  
b7c

BT

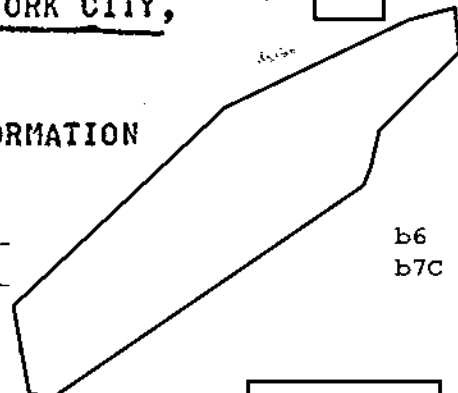

185-1563-7

SEP 16 1981

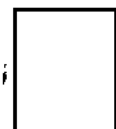

b6  
b7c

10

FBI

~~CONFIDENTIAL~~

TRANSMIT VIA:

- Teletype
- Facsimile
- Airtel

PRECEDENCE:

- Immediate
- Priority
- Routine

CLASSIFICATION:

- TOP SECRET
- SECRET
- CONFIDENTIAL
- UNCLAS E F T O
- UNCLAS

Date 9/17/81

TO: DIRECTOR, FBI

FROM: SAC, ALEXANDRIA (185-110) (RUC)

POSSIBLE VISIT OF CUBAN  
PRESIDENT FIDEL CASTRO  
TO NEW YORK CITY,  
9/4-6/81  
PFO  
(OO:NEW YORK)

Inasmuch as no positive information has been developed concerning captioned matter in the Alexandria Division, and the date of the possible visit by Castro is past, this matter is being RUC'd by Alexandria. (S) (U)

~~CLASSIFIED AND EXTENDED BY 10010~~  
~~IN FOR EXTENSION FCIM, II, 1-2.4.2 (2, 3)~~  
~~DATE OF REVIEW FOR DECLASSIFICATION 9/17/2001~~

②-Bureau  
2-New York  
1-Alexandria

(5)

185-1563-10

16 SEP 21 1981

1\*

Approved: LKY

Transmitted \_\_\_\_\_

(Number)

(Time)

81

b6  
b7C

b6  
b7C

b6  
b7C

b6  
b7C

FBI

TRANSMIT VIA:

- Teletype
- Facsimile
- Airtel

PRECEDENCE:

- Immediate
- Priority
- Routine

CLASSIFICATION:

- TOP SECRET
- SECRET
- CONFIDENTIAL
- UNCLAS E F T O
- UNCLAS

Date 9/28/81

b6  
b7C

TO: DIRECTOR, FBI

FROM: SAC, ATLANTA (185-64) (RUC) (Sq. 3)

POSSIBLE VISIT OF CUBAN PRESIDENT  
FIDEL CASTRO TO NEW YORK CITY,  
SEPTEMBER 4 - 6, 1981  
 PFO  
 OO: NEW YORK

*J*

(X)

b6  
b7C

ReButel, 8/27/81.

Established sources in the Atlanta Division, who are knowledgeable concerning Cuban activities, were able to provide no information that Castro would be the target of violence during his visit to New York City.

*185-1563-11*

1\*

061 5 1981

- ② - Bureau
- 2 - New York
- 1 - Atlanta

[Redacted]  
 (5)

[Redacted]

b6  
b7C

Approved: [Signature]

Transmitted \_\_\_\_\_ (Number) \_\_\_\_\_ (Time)

Per \_\_\_\_\_

FEDERAL BUREAU OF INVESTIGATION  
FOI/PA  
DELETED PAGE INFORMATION SHEET  
FOI/PA# 1362425-000

Total Deleted Page(s) = 23

- Page 4 ~ Duplicate;
- Page 5 ~ Duplicate;
- Page 7 ~ Duplicate;
- Page 8 ~ Duplicate;
- Page 9 ~ Duplicate;
- Page 10 ~ Duplicate;
- Page 11 ~ Duplicate;
- Page 12 ~ Duplicate;
- Page 13 ~ Duplicate;
- Page 14 ~ Duplicate;
- Page 15 ~ Duplicate;
- Page 16 ~ Duplicate;
- Page 17 ~ Duplicate;
- Page 18 ~ Duplicate;
- Page 19 ~ Duplicate;
- Page 20 ~ Duplicate;
- Page 21 ~ Duplicate;
- Page 22 ~ Duplicate;
- Page 23 ~ Duplicate;
- Page 24 ~ Duplicate;
- Page 25 ~ Duplicate;
- Page 26 ~ Duplicate;
- Page 27 ~ Duplicate;

```
XXXXXXXXXXXXXXXXXXXXXXXXXXXXX  
X Deleted Page(s) X  
X No Duplication Fee X  
X For this Page X  
XXXXXXXXXXXXXXXXXXXXXXXXXXXXX
```

UNITED STATES DEPARTMENT OF JUSTICE  
FEDERAL BUREAU OF INVESTIGATION

MEMORANDUM

DATE: 8/28/81

TO : SAC II

FROM : SUPV.

b6  
b7c

SUBJECT: TITLE OF CASE *Visit of Field Center; PFE only*

On 8/28/81 I authorized, in accordance with the Attorney General's Guidelines on Criminal Investigations of Individuals and Organizations, a (General Crimes) (~~Preliminary~~) (~~Racketeering Enterprise~~) investigation based upon:

(a) The following facts or circumstances, or

(b) the facts and circumstances contained in the attached documents.  8/27/81

b6  
b7c

MAINTAIN AS TOP SERIAL.

DATES OF SUBSEQUENT REVIEW OF JURISDICTION RECORDED

ON BACK.

# Memorandum



To : SAC (185-1076) C

Date 3/15/82

From : SA

b6  
b7C

Subject : POSSIBLE VISIT OF CUBAN PRESIDENT  
FIDE CASTRO TO NEW YORK,  
PFO  
OO: NEW YORK

Contact with representatives of U.S. Department of State and U.S. Secret Service have been negative to date re any plans of Castro to visit the United States.

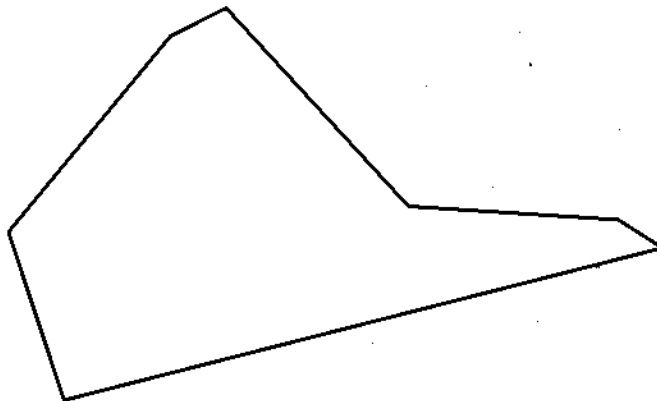

b6  
b7C

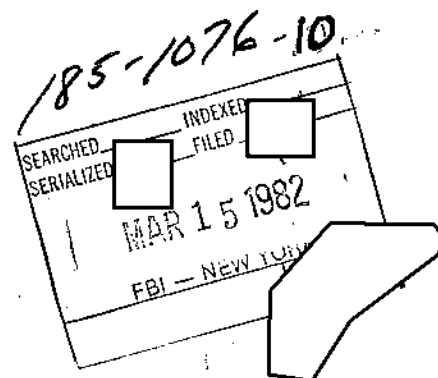

FEDERAL BUREAU OF INVESTIGATION  
FOI/PA  
DELETED PAGE INFORMATION SHEET  
FOI/PA# 1362425-000

Total Deleted Page(s) = 6  
Page 3 ~ Duplicate;  
Page 4 ~ Duplicate;  
Page 5 ~ Duplicate;  
Page 6 ~ Duplicate;  
Page 9 ~ Duplicate;  
Page 10 ~ Duplicate;

XXXXXXXXXXXXXXXXXXXXXXXXXXXX  
X Deleted Page(s) X  
X No Duplication Fee X  
X For this Page X  
XXXXXXXXXXXXXXXXXXXXXXXXXXXX



b6  
b7C  
CI-12

VZCZCH00125 2452301

RR HI MM NY NY WFO

DE SJ MCN0009

R 022750Z SEP 81

FM SAN JUAN (135-70) (P)

TO DIRECTOR ROUTINE

MIAMI ROUTINE

NEW YORK ROUTINE

NEWARK ROUTINE

WFO ROUTINE

BT

No CFR Check

~~CONFIDENTIAL~~

POSSIBLE VISIT OF CUBAN PRESIDENT FIDEL CASTRO TO NEW YORK  
CITY, SEPTEMBER 4-6, 1981; PFO; OO: NEW YORK

THIS ENTIRE COMMUNICATION CLASSIFIED "~~CONFIDENTIAL~~" UNLESS  
OTHERWISE NOTED.

RE BUTEL TO ALL OFFICES, AUGUST 27, 1981.

ON SEPTEMBER 2, 1981, [redacted] A SOURCE OF PROVEN  
RELIABILITY, WAS CONTACTED RE CAPTIONED MATTER.

b7D

SOURCE STATED THAT HE HAS NOT DEVELOPED ANY INFORMATION  
PERTAINING TO ANY ACTIVITIES BY ANTI-CASTRO GROUPS RE POSSIBLE  
VISIT OF CUBAN PRESIDENT FIDEL CASTRO.

185-1010-2

SEARCHED [ ] INDEXED [ ]  
SERIALIZED [ ] FILED [ ]

SEP 27 09 PM '81

FBI-WASH F O

[redacted]

b6  
b7C

[redacted]

.PAGE TWO SJ 185-79 ~~C O N F I D E N T I A L~~

SOURCE, HOWEVER, DID STATE THAT [REDACTED]

b7D

SOURCE STATED THAT [REDACTED]

b7D

SOURCE STATED THAT [REDACTED]

b6  
b7C  
b7D

SOURCE CLAIMS [REDACTED]

b7D

SOURCE STATED [REDACTED]

b7D

~~C & F 10239; REASONS 2 & 3; DRD SEPTEMBER 2, 2001.~~

BT

# Memorandum



To SAC, WFO (185-1010) (RUC)

Date 10/19/81

From SA [redacted]

b6  
b7C

Subject POSSIBLE VISIT OF CUBAN PRESIDENT  
FIDEL CASTRO TO NEW YORK CITY  
SEPTEMBER 4-6, 1981;  
PFO  
(OO:NY)

On 8/31/81, [redacted]  
[redacted]  
was contacted and was advised that writer was coordinating  
the Federal Bureau of Investigation (FBI), Washington  
Field Office (WFO) interest in captioned visit.

b6  
b7C  
b7E

[redacted] was recontacted on 9/14/81 and 9/17/81.  
[redacted] advised that the Castro visit was being postponed.

On 10/13/81, [redacted] advised that the Castro visit  
may not take place.

In view of the above, WFO is <sup>close</sup> RUCing instant case.

[redacted] WFO  
[redacted]  
(1)

*Close*  
*10-19-81*  
*10/19/81*  
[redacted]

*185-1010-3*

SEARCHED	INDEXED
SERIALIZED	FILED
OCT 20 1981	
FBI-WASH. FIELD OFFICE	

[redacted]

b6  
b7C

FEDERAL BUREAU OF INVESTIGATION  
FOI/PA  
DELETED PAGE INFORMATION SHEET  
FOI/PA# 1362425-000

Total Deleted Page(s) = 3  
Page 4 ~ Duplicate;  
Page 5 ~ Duplicate;  
Page 6 ~ Duplicate;

XXXXXXXXXXXXXXXXXXXXXXXXXXXX  
X Deleted Page(s) X  
X No Duplication Fee X  
X For this Page X  
XXXXXXXXXXXXXXXXXXXXXXXXXXXX

- 1 -

## FEDERAL BUREAU OF INVESTIGATION

Date of transcription 10/10/2006

MIGUEL LUIS TALLEDA, date of birth June 14, 1919, was interviewed at his residence, [redacted] Torrance, California. TALLEDA's home telephone number is [redacted] Also present for the interview was [redacted] and [redacted] Detective, Torrance Police Department. After being advised of the identity of the interviewing agent and officer, TALLEDA provided the following information:

b6  
b7C

TALLEDA had never heard of [redacted] [redacted] ALPHA 66 issued a statement locally and nationally through the Cuban journal "VEINTE DE MAYO" that [redacted] is not a member of ALPHA 66, nor do they know him. TALLEDA opined that [redacted] may have been dealing with gangs. There was an article on [redacted] written in the Spanish language posted [redacted] at the Website www.granma.cu.

b6  
b7C

TALLEDA is the ALPHA 66 Coordinator for California and an ALPHA 66 National Executive. TALLEDA has been a member of ALPHA 66 since 1963. He came to the United States from Cuba in 1962, originally staying in Miami, Florida. Approximately 45-days later TALLEDA moved to Alhambra, California and then to Torrance, where he has remained for the past 30 years. He moved from Florida because he was only able to find jobs that required heavy labor and he was used to working as an accountant at a sugar mill office. TALLEDA tried two or three jobs in Southern California before he got his current job at a furniture store called HAMMER FURNITURE located in Gardena, California. TALLEDA still works there two-days per week.

TALLEDA showed interviewing agent his ALPHA 66 identification card which was issued in Miami, Florida on September 2, 1991 by then ALPHA 66 Secretary General ANDRES NAZARIO SARGEN (deceased as of approximately two years ago). The identification card is driver's license size, orange in color, with a green diagonal stripe with "ALPHA 66" written inside the diagonal stripe in white letters. There are no membership dues, but donations are accepted. ALPHA 66 does not conduct any background investigations on members, but they closely watch new members.

When ALPHA 66 has a banquet, a lot of Cubans attend. They also have a large, annual Christmas party in the Los Angeles

Investigation on 10/6/2006 at Torrance, California

File # [redacted] Date dictated [redacted]

by SA [redacted]

b6  
b7C  
b7E

[REDACTED]

b7E

Continuation of FD-302 of Miguel Luis Talleda, On 10/6/2006, Page 2

area. Los Angeles area meetings are held every one or two months at local restaurants or TALLEDA's home or other members' homes. TALLEDA's group has no intention of setting up a commando team.

The current [REDACTED] of ALPHA 66 is [REDACTED]

b6  
b7C

[REDACTED]

ALPHA 66 was founded by 66 Cuban exiles in Puerto Rico in November 1961. Membership has gotten smaller due to gas prices and aging members. There are approximately 1,000 members in the United States. New York, New Jersey, San Francisco, Chicago, and Miami (ALPHA 66 Headquarters) all have substantial membership. There are approximately 100 members in the Los Angeles, California area and 10-20 members in San Diego, California. The ALPHA 66 Miami Headquarters maintains membership lists and TALLEDA would not provide a membership list.

ALPHA 66 did some commando raids into Cuba in the 1970s. TALLEDA never went on any of these raids nor has he received any military training or served in any military. ALPHA 66 does not have any current plans to invade Cuba, especially because of the strict homeland security rules and U.S. Coast Guard presence between Florida and Cuba. ALPHA 66 has membership in Cuba but ALPHA 66 keeps their identities secret to protect these members as the Cuban government considers ALPHA 66 terrorists.

Circa 1980-1981, ALPHA 66 had a training camp in the mountains of the Mojave Desert in California. The FBI visited this site, but ALPHA 66 did not have anything to hide. They used the camp to teach Cubans how to fight and shoot firearms. It was more of a propaganda campaign for publicity and was used by ALPHA 66 members from Southern California. They had to close the camp.

People in the United States listening to the radio and reading the newspapers don't care how dangerous CASTRO is. Americans are more aware of what is happening in Latin America because of HUGO CHAVEZ's recent inflammatory remarks regarding PRESIDENT GEORGE W. BUSH. CHAVEZ is running Cuba because he provides Cuba with oil.

Recounting his experience from the Cuban Revolution, TALLEDA indicated they fought BATISTA for seven years and then FIDEL CASTRO took over, and since he was another dictator they fought him. TALLEDA saw CASTRO in person on only one occasion when

[REDACTED]

b7E

Continuation of FD-302 of Miguel Luis Talleda, On 10/6/2006, Page 3

TALLEDA and some of his colleagues were putting flowers at a bridge where two of their comrades were killed fighting BATISTA. CASTRO also fought against BATISTA.

[REDACTED]

b3  
b7E

TALLEDA believes the CASTRO regime will be overtaken in TALLEDA's lifetime. [REDACTED] is just as dangerous as FIDEL CASTRO. [REDACTED] used to execute BATISTA's captured soldiers. TALLEDA believed there are a lot of plans in the works to overthrow CASTRO. Eighty-five to 90 percent of Cubans are against CASTRO. Infiltrations into Cuba occurred into the 1980s, but they were caught and killed.

b6  
b7C

ALPHA 66 does not send money to Cuba because CASTRO will take it. They use money to maintain their offices in Miami and New York, and a training camp in Miami. They use the training camp for shooting firearms.

ALPHA 66 is friendly with everyone in Cuba who is against CASTRO. There are journalists in Cuba who are friendly with the American Embassy in Havana, Cuba. Most Cubans are Republicans because most Democrats like CASTRO. ALPHA 66's Website is [www.Alpha66.org](http://www.Alpha66.org). TALLEDA wrote a book on ALPHA 66 in the Spanish language, entitled "ALPHA 66 Y SU HISTORICA TAREA".

TALLEDA is very pro-American and harbors no ill-will toward Americans or the United States. TALLEDA believes the only way to get rid of CASTRO is through violent overthrow.

TALLEDA had been contacted by the FBI circa 20 years-ago. The special agent's name was first name unknown, last name [REDACTED]

TALLEDA was interviewed by reporter [REDACTED] regarding ALPHA 66 on a Torrance television news station a few months ago. TALLEDA showed interviewing agent and officer the news segment on DVD.

b6  
b7C